

Pillar Lite ULTRA 50

PROJECT:

TYPE:

SOURCE:

NOTES:

SPECIFICATIONS



LED Chip	Cree CXA 2540 field replaceable LED board
Luminaire Output	2800 Lumens minimum @ 700mA (26 watts), delivered from the Luminaire with unobstructed beam
Lumens Per Watt	107 Lumens minimum @ 52 watts, delivered from Luminaire with unobstructed beam
CRI (3000K)	80 Standard, 90+ Optional
Colour Temperatures	2700K, 3000K, 4000K
Beam Angles	13, 22, 33, 51
Ingress Protection	IP66
Warranty	Electronics = 5 years Body Aluminium = 5 years
Standards	BS/EN 60598.2.2 cUL 1598 CE

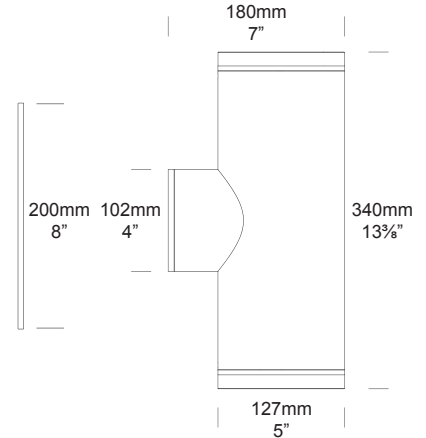

PRODUCT CONFIGURATION

Please fill in appropriate codes into boxes provided

Cat. No. PIL/U50

Luminaire	Power	Material/Finish	Beam	Colour	Accessories
<input type="text" value="PIL/U50"/>	<input type="text"/>	<input type="text"/>	<input type="text"/>	<input type="text"/>	<input type="text"/>
SR 700mA Input, Series Wired 52W R RETRO, 120-277VAC Input, Parallel Wired		ALUMINIUM EBK BLACK EBZ BRONZE EOGR OLIVE GREEN EWH WHITE EWB WHITE BIRCH EDG DARK GREY ESTAR SILVER STAR ECT CORTEN	22 22° 33 33° 51 51° 13 13° Requires Lens Ring extension	2 2700K 3 3000K 4 4000K 39 3000K, 90+ CRI	CJK CABLE JOINT KIT GG/U50 GLARE GUARD GS05 GLARE SHIELD HCL/U50 HEX CELL LOUVRE LF FROSTED LENS SNT/U50 SNOOT ULTWP WALL PLATE

SERIES REMOTE:
Constant current driver (included) individual fixtures require 74vdc @ 700mA maximum. 0-10 volt dimming.

RETRO 110-277vac DRIVER:
Constant current driver (included).
Input: 120, 240, 277 volts
Output: 60 watts total 74vdc @ 1400mA. 0-10 volt dimming.

ADDITIONAL COMMENTS:

LUMINAIRE CONSTRUCTION

CNC machined from one of the following metals:

Aluminium:

Base: 105mm (5¹/₈") solid aluminium rod.
 Body: 127mm (5") high corrosion resistant aluminium tube with chromate substrate and high UV resistant polyester powder coat.
 Colours: Black, Bronze, Silver Star, White, White Birch, Olive Green, Dark Grey, Corten.

Cable:

Water resistant rubber.

Gaskets:

Silicone, iron impregnated 220°C (428°F).

Step Lens:

12mm (1/2") extra clear, low iron, shatter resistant glass.
 Lifetime warranty.

Mounting:

The mounting plate is fixed to the surface using three stainless steel screws. The luminaire is then fixed to the mounting plate. A large Wall Plate is available for mounting over junction boxes.

Luminaire Weight:

8kg (17lb 10oz)

ACCESSORIES

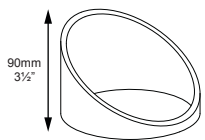

Glare Guard

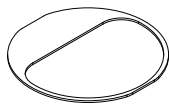

Glare Shield

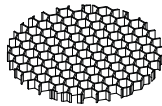

Hex Cell Louvre

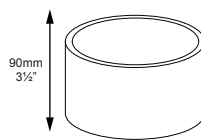

Snoot

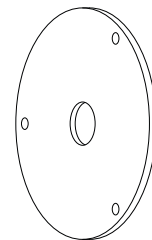

Wall Plate 200mm (8")

BEAM ANGLES

High efficiency Reflectors. Field replaceable

IES files available for download: <http://www.hunzalighting.com/download.php>

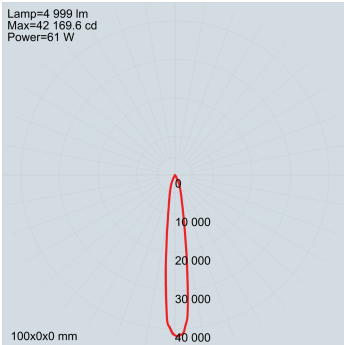

13° FWHM REFLECTOR

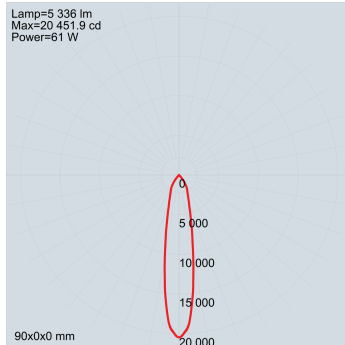

22° FWHM REFLECTOR

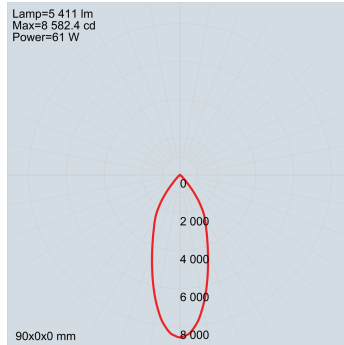

33° FWHM REFLECTOR

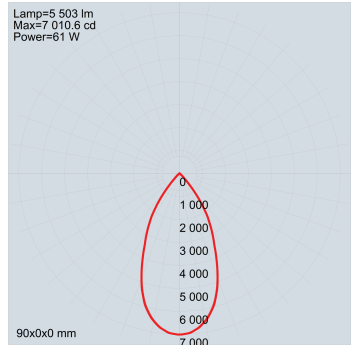

51° FWHM REFLECTOR

WIRING GUIDE

Available for download: www.hunzalighting.com/download.php

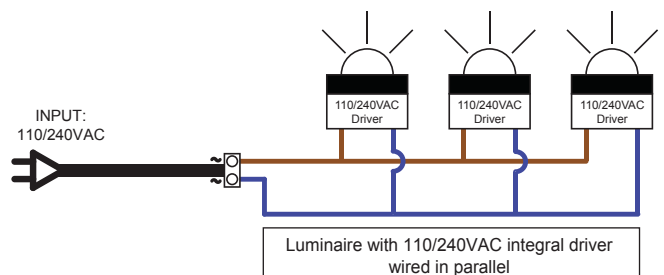
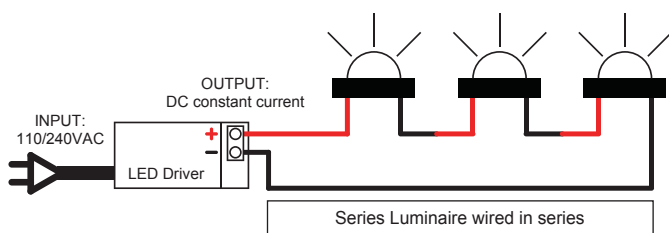

Diagrams are a guide only, wire colours and polarity may change depending on fixture and country

Specifications may change without notification

Aug 2017