

Pole Flood ULTRA 50

PROJECT:

TYPE:

SOURCE:

NOTES:

SPECIFICATIONS



LED Chip	Cree CXA 2540 field replaceable LED board
Luminaire Output	5000 Lumens minimum @ 1400mA (52 watts), delivered from the Luminaire with unobstructed beam
Lumens Per Watt	96 Lumens minimum @ 52 watts, delivered from Luminaire with unobstructed beam
CRI (3000K)	80 Standard, 90+ Optional
Colour Temperatures	2700K, 3000K, 4000K
Beam Angles	13, 22, 33, 51
Ingress Protection	IP66

Warranty	Electronics = 5 years Body Aluminium = 5 years
Standards	BS/EN 60598.2.2 cUL 1598 CE

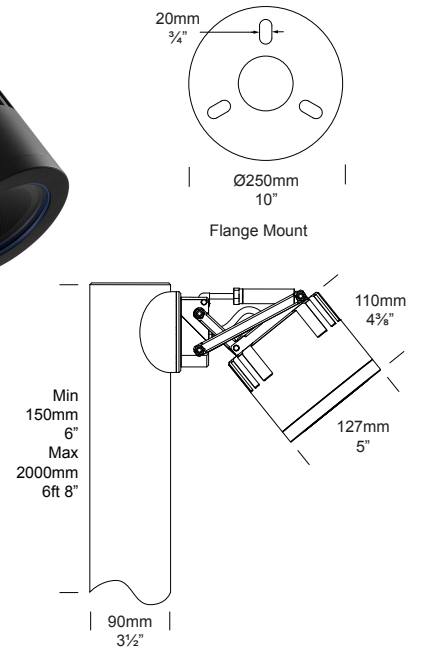

PRODUCT CONFIGURATION

Please fill in appropriate codes into boxes provided

Cat. No. PFL/U50

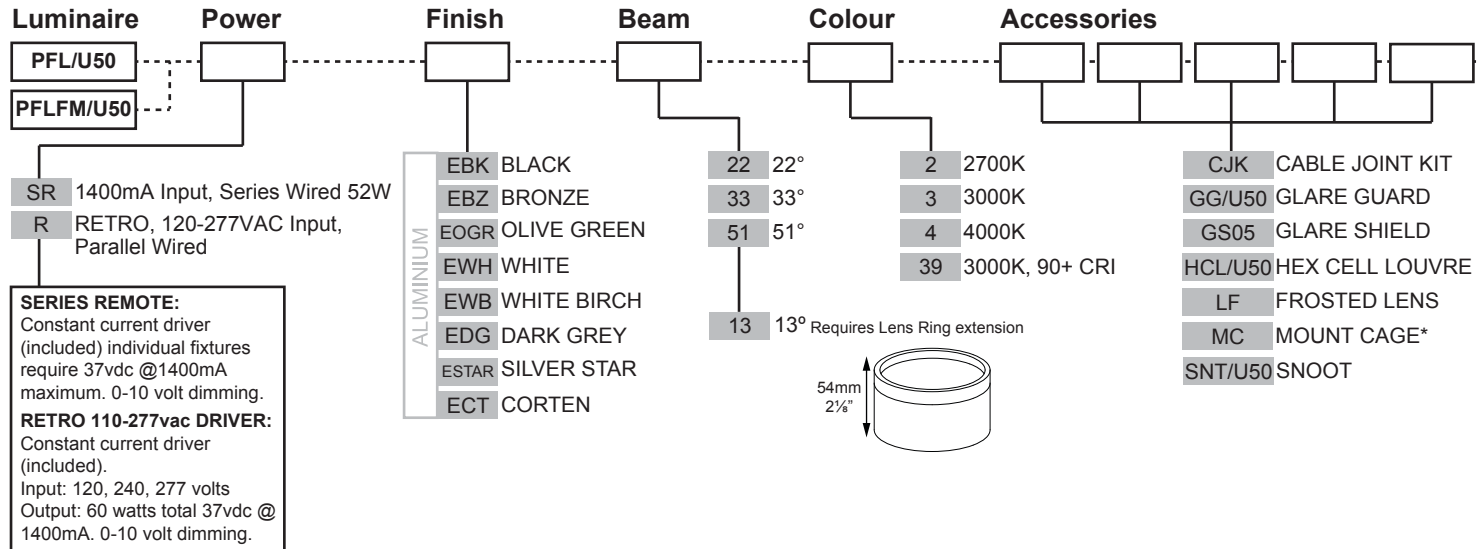

*Only available for Flange Mount Version

ADDITIONAL COMMENTS:

LUMINAIRE CONSTRUCTION

CNC machined from one of the following metals:

Aluminium:

Base: 130mm (5¹/₈") solid aluminium rod.
 Pole: 90mm (3¹/₂") high corrosion resistant aluminium tube with chromate substrate and high UV resistant polyester powder coat.
 Colours: Black, Bronze, Silver Star, White, White Birch, Olive Green, Dark Grey, Corten.

316 Stainless Steel:

Fixing and Tilting Mechanism: various rod sizes of 316 stainless steel.

Adjustability:

The fully adjustable head allows 360 degree rotation and 0-80 degree elevation. Can then be fixed in place using the inbuilt mechanism.

Cable:

Water resistant rubber.

Gaskets:

Silicone, iron impregnated 220°C (428°F).

Step Lens:

12mm (1/2") extra clear, low iron, shatter resistant glass.
 Lifetime warranty.

Mounting:

The pole is cast into concrete or mounted via flange mount - please refer to the Hunza website for mounting instructions.

Luminaire Weight:

5kg (11lb) - head only

ACCESSORIES

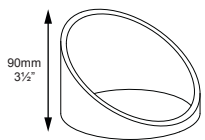

Glare Guard

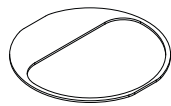

Glare Shield

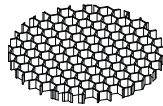

Hex Cell Louvre

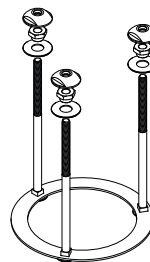

Mounting Cage

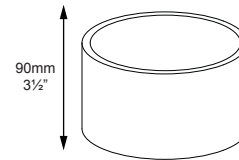

Snoot

BEAM ANGLES

High efficiency Reflectors. Field replaceable

IES files available for download: <http://www.hunzalighting.com/download.php>

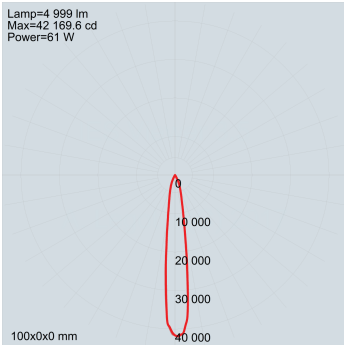

13° FWHM REFLECTOR

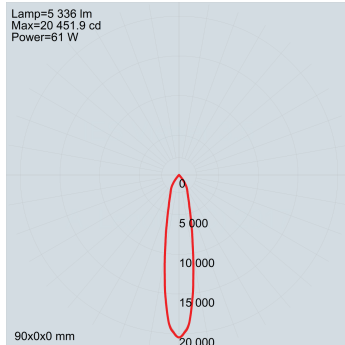

22° FWHM REFLECTOR

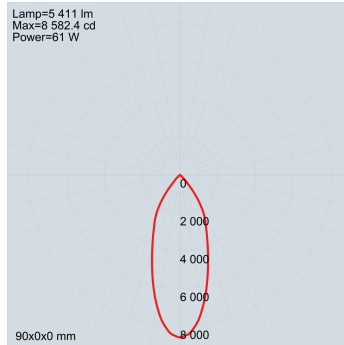

33° FWHM REFLECTOR

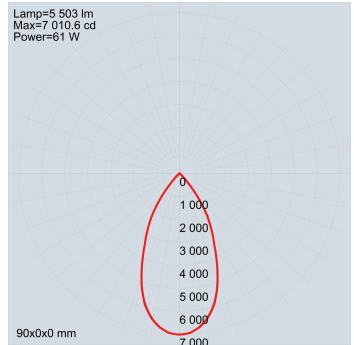

51° FWHM REFLECTOR

WIRING GUIDE

Available for download: www.hunzalighting.com/download.php

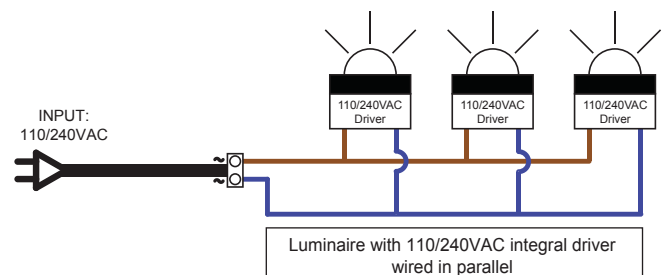
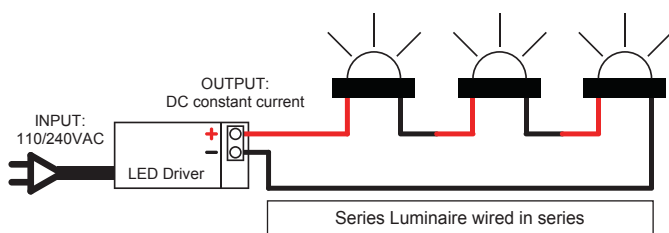

Diagrams are a guide only, wire colours and polarity may change depending on fixture and country

Specifications may change without notification

Aug 2017