

## Twig Lite

PROJECT:

TYPE:

SOURCE:

NOTES:

### PURELED SPECIFICATIONS

<b>LED Chip</b>	Cree XPG-3 Plug and Play field replaceable LED board
<b>Luminaire Output</b>	120 Lumens @ 700mA (2 watts), delivered from luminaire with unobstructed beam.
<b>Lumens Per Watt</b>	60 Lumens minimum @ 2 watts, delivered from luminaire with unobstructed beam
<b>CRI (3000K)</b>	90+
<b>Colour Temperatures</b>	2700K, 3000K, 4000K
<b>Beam Angles</b>	Asymmetric
<b>Ingress Protection</b>	IP44

<b>Warranty</b>	Electronics = 5 years Body Cop/SS = 10 years
<b>Standards</b>	AS/NZS 61046 cUL 1838, 2108 CSA C22.2 No.250.7, No.250.0-08 CE

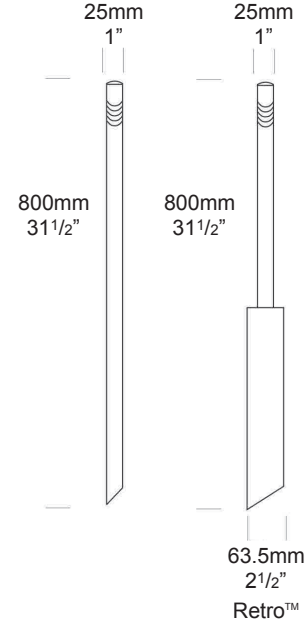

### PRODUCT CONFIGURATION

Please fill in appropriate codes into boxes provided

Cat. No. TG/L

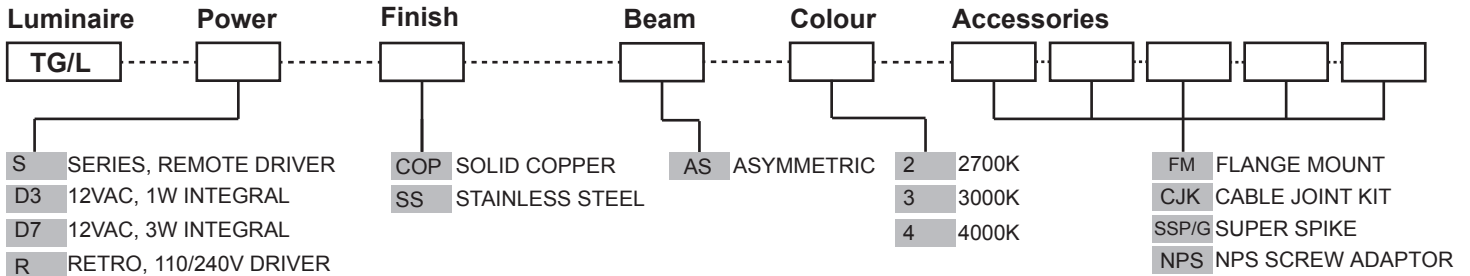

#### SERIES, REMOTE DRIVER REQUIRED:

Constant current driver  
Individual fixtures require 3vdc @ 700mA maximum

#### 12VAC INTEGRAL DRIVER:

Hunza Buckbullet driver (included)  
Input: 12VAC, 2watt at 700mA  
Output: 6vdc @ D3=350mA, D7=700mA

#### 110/240VAC RETRO DRIVER:

Input: 120/240vac, 2 watt total (included)  
Output: 3vdc, 700mA  
0-10 volt dimming (USA - non dimming)

[Click here for halogen specification sheet](#)

#### OTHER LAMP OPTIONS

TG /H - G4 Halogen 12V Lamp  
TG /GL - G4 LED Retrofit 12V Lamp (lamps vary by market - please refer to supplier for details)

[Click for here Remote Power Supply Guidance Charts](#)

# LUMINAIRE CONSTRUCTION

## CNC machined from one of the following metals:

### Copper

Pole: solid copper 25.4mm (1") rod.  
End cap: solid copper 25.4mm (1") rod.

### 316 Stainless Steel

Pole: 316 stainless steel 25.4mm (1") rod.  
End cap: 316 stainless steel 25.4mm (1") rod.

### Lens:

22mm (3/4") extra clear low iron flush fit shatter resistant glass tube.  
Lifetime warranty.

### Gaskets:

Silicone, iron impregnated 220°C (428°F).

## Mounting

The pole 800mm (31½") is directly mounted into the earth or concrete. For extra stability in sand or loose ground use the Super Spike. Flange Mount option is available for hard surfaces.

## Luminaire Weight:

Low voltage  
Cop: 0.800kg (1lb 12oz)  
SS: 0.800kg (1lb 12oz)  
Retro™  
Cop: 1.980kg (4lb 6oz)  
SS: 1.980kg (4lb 6oz)

## ACCESSORIES

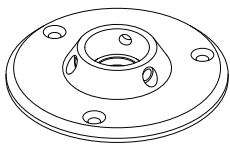

Flange Mount

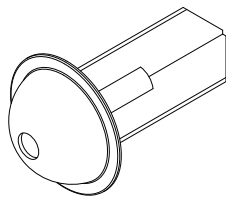

Super Spike

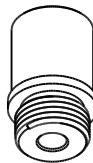

NPS 1/2"  
Screw Mount Adaptor

## BEAM ANGLES

High efficiency PMMA TIR lenses. Field replaceable

IES files available for download: [hunzalighting.com/downloads](http://hunzalighting.com/downloads)

## WIRING GUIDE

### Series/remote driver

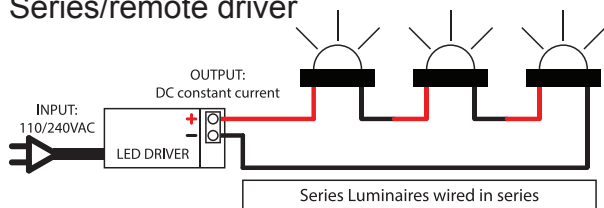

Diagrams are a guide only, wire colours and polarity may change depending on fixture and country

Available for download: [hunzalighting.com/downloads](http://hunzalighting.com/downloads)

### 12v integral driver

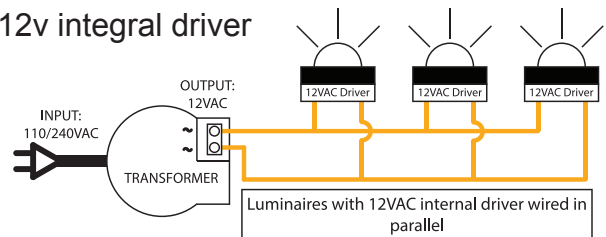

Specifications may change without notification

Aug 2017