

Pillar Lite High Power PURE LED

PROJECT: _____

TYPE: _____

SOURCE: _____

NOTES: _____

SPECIFICATIONS PER HEAD



LED Chip	Cree CXA1512 Plug and Play field replaceable LED board
Luminaire Output	1200 Lumens @ 700mA delivered from luminaire with unobstructed beam.
Lumens Per Watt	100 Lumens minimum @ 12 watts, delivered from luminaire with unobstructed beam
CRI (3000K)	85+ Standard, 90+ Optional
Colour Temperatures	2700K, 3000K, 4000K
Beam Angles	15, 30, 40
Ingress Protection	IP66

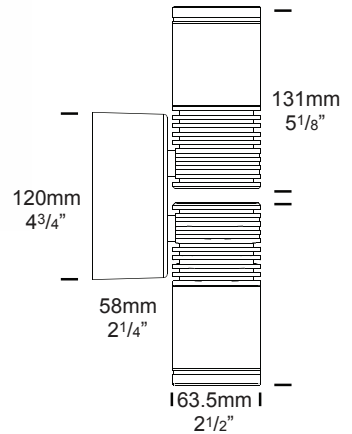

Warranty	Electronics = 5 years Body Aluminium = 5 years
Standards	AS/NZS 61046, EN60598 cUL 1838, 2108, 1598 CSA C22.2 No. 250.7, No. 250.0-08, No. 250.0 CE

PRODUCT CONFIGURATION

Please fill in appropriate codes into boxes provided

Cat. No. PIL/HP

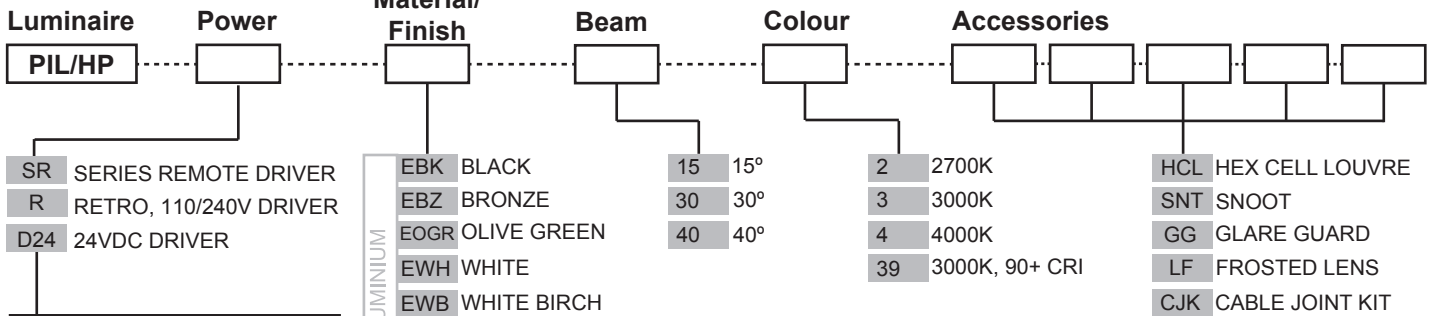

SERIES REMOTE DRIVER:
Constant current driver (included) individual fixtures require 18vdc @ 700mA maximum. 0-10 volt dimming.

RETRO 110/240VAC DRIVER:
Constant current driver (included).
Input: 90/305vac, 25 watt total.
Output: 18vdc, 700mA
0-10 volt dimming

24VDC DRIVER:
Input: 24vdc.
Output: 18vdc @ 700mA constant current (non dimming).
Note: not for USA.

ADDITIONAL COMMENTS: _____

LUMINAIRE CONSTRUCTION

CNC machined from one of the following metals:

Aluminium:

Body: high corrosion resistant 63.5mm solid aluminium tube with chromate substrate and high UV resistant polyester "E" powder coat.
Colours:
Black, Bronze, Silver Star, White, White Birch, Olive Green, Dark Grey, Corten.

Mounting:

A mounting plate is fixed to the wall using two screws and the luminaire is fitted to the mounting plate.

Luminaire Weight:

Low voltage:
Alum: 0.870 (1lb 15oz)

Lens:

10mm (3/8") Extra clear, low iron, shatter resistant glass.
Lifetime warranty.

Gaskets:

Silicone, iron impregnated 220°C (428°F)

ACCESSORIES

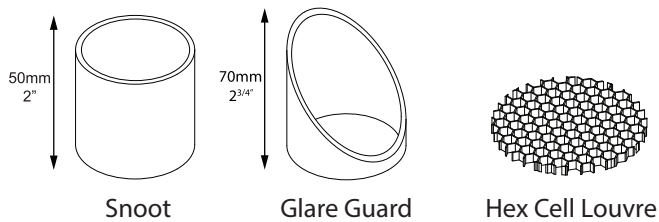

BEAM ANGLES

High efficiency PMMA TIR lenses. Field replaceable

IES files available for download: hunzalighting.com/downloads

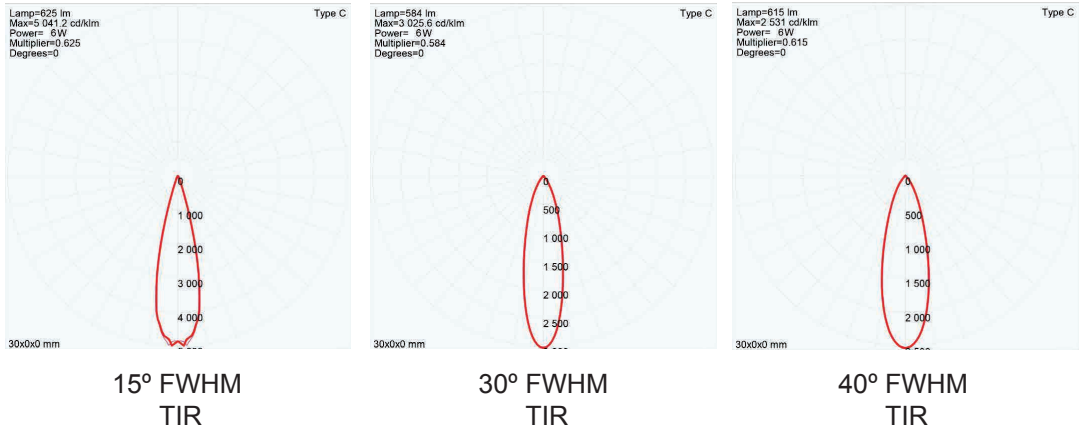

WIRING GUIDE

Available for download: hunzalighting.com/downloads

Series/remote driver

110/240v integral driver

24vdc integral driver

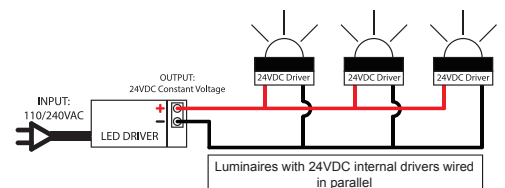
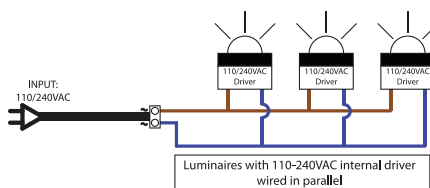
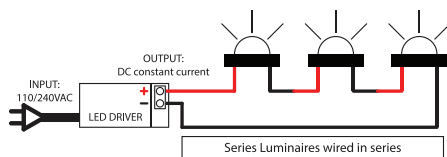

Diagrams are a guide only, wire colours and polarity may change depending on fixture and country

Specifications may change without notification

Aug 2017