

PROJECT:
TYPE:
SOURCE:
NOTES:

### PURELED SPECIFICATIONS

<b>LED Chip</b>	Cree XHP-50-2 Plug and Play field replaceable LED board
<b>Luminaire Output</b>	600 Lumens @ 1050mA (6 watts), 420 Lumens @ 700mA (4 watts), 240 Lumens @ 350mA (2 watts), delivered from luminaire with unobstructed beam.
<b>Lumens Per Watt</b>	100 Lumens minimum @ 6 watts, delivered from luminaire with unobstructed beam
<b>CRI (3000K)</b>	90+
<b>Colour Temperatures</b>	2700K, 3000K, 4000K
<b>Beam Angles</b>	15, 25, 38, 60
<b>Ingress Protection</b>	IP66
<b>Warranty</b>	Electronics = 5 years Body Cop/ SS = 10 years Body Aluminium = 5 years
<b>Standards</b>	AS/NZS 61046, EN60598 cUL 1838, 2108, 1598 CSA 22.2 No. 250.7, No. 250.0-08, No. 250.0 CE

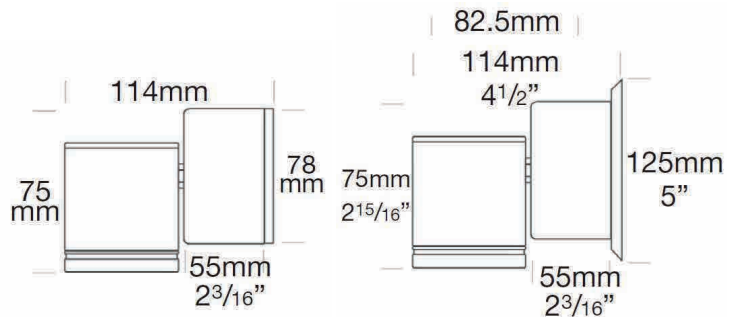
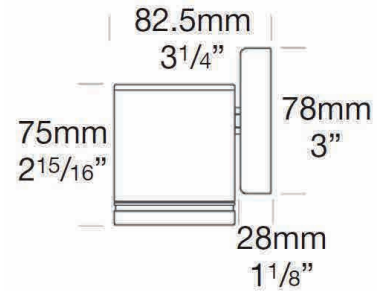

Retro

Retro USA/Canada

### PRODUCT CONFIGURATION

Please fill in appropriate codes into boxes provided

Cat. No. DL/L

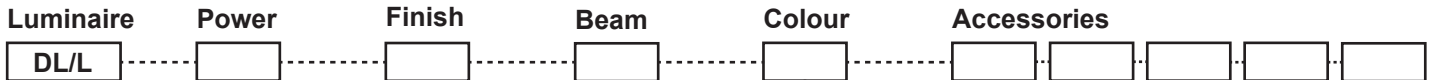

- S SERIES, REMOTE DRIVER
- D3 12VAC, 2W INTEGRAL
- D7 12VAC, 4W INTEGRAL
- D10 12VAC, 6W INTEGRAL
- R RETRO, 110/240V DRIVER

- ALUMINIUM
- EBK BLACK
  - EBZ BRONZE
  - EOGR OLIVE GREEN
  - EWH WHITE
  - EWB WHITE BIRCH
  - EDG DARK GREY
  - ESTAR SILVER STAR
  - ECT CORTEN
- COP SOLID COPPER  
SS STAINLESS STEEL

- 15 15°
- 25 25°
- 38 38°
- 60 60°

- 2 2700K
- 3 3000K
- 4 4000K

- HCL HEX CELL LOUVRE
- SNT SNOOT
- GG GLARE GUARD
- LF FROSTED LENS
- WBAP WALL BOX ADAPTOR
- CJK CABLE JOINT KIT
- TLTM TILTING MODULE

**SERIES, REMOTE DRIVER REQUIRED:**

Constant current driver  
Individual fixtures require 6vdc @ 1050mA maximum

**12VAC INTEGRAL DRIVER:**  
Hunza integrated plug and play driver (included)  
Input: 9-15VAC.  
Output: 6vdc @ D3=350mA, D7=700mA, D10=1050mA (1050mA limited to ≤ 40°C (104°F) ambient temperature in stainless steel)

**110/240VAC RETRO DRIVER:**  
Input: 120/240vac, 5 watt total (driver included)  
Output: 6vdc, 700mA  
0-10 volt dimming (USA - non dimming)

**OTHER LAMP OPTIONS:**

- DL/H - MR16 Halogen 12V Lamp
- DL/SL - MR16 LED Retrofit 12V Lamp (lamps vary by market - please refer to supplier for details)
- DL/GUH - GU10 120/240V Halogen Lamp (body length increases for all GU10 lamps)
- DL/GUSL - GU10 LED Retrofit 120/240V Lamp (lamps vary by market - please refer to supplier for details)

[Click here for halogen specification sheet](#)

[Click here for Remote Power Supply Guidance Charts](#)

# LUMINAIRE CONSTRUCTION

## CNC machined from one of the following metals:

### Aluminium:

Body: high corrosion resistant 63.5mm (2<sup>1/2"</sup>) x 10mm (3/8") aluminium.

End cap: solid aluminium 63.5mm (2<sup>1/2"</sup>) rod.

Base and Mounting Plate (Retro™): hand spun 2mm aluminium disk. Base cast from virgin high corrosion resistant CC401 low copper aluminium alloy chromate substrate and high UV resistant polyester powder coat.

### Colours:

Black, Bronze, Silver Star, White, White Birch, Olive Green, Dark Grey, Corten.

### Copper:

Body: 63.5mm (2<sup>1/2"</sup>) x 10mm (3/8").

End cap: solid copper 63.5mm (2<sup>1/2"</sup>) rod.

Base and Mounting Plate (Retro™): handspun 2mm (5/64") copper disk and forged brass

### 316 Stainless Steel:

Body: 63.5mm (2<sup>1/2"</sup>) x 10mm (3/8").

End cap: solid 316 stainless steel 63.5 (2<sup>1/2"</sup>) rod.

Base and Mounting Plate: investing cast and CNC machined 316 stainless steel.

### Step Lens:

10mm (3/8") extra clear, low iron, shatter resistant glass.

Lifetime warranty

### Gaskets:

Silicone, iron impregnated 220°C (428°F)

### Mounting:

12 volt: the luminaire is mounted to the wall using two 316 stainless screws through a shallow base 28mm (1<sup>1/8"</sup>) in depth.

Retro™ (110/240-12volt): a mounting plate is fixed to the wall using two screws and the luminaire is fitted to the mounting plate.

### Luminaire Weight:

Low voltage

Alum: 0.460kg (1lb)

Cop: 1.200kg (2lb 10oz)

SS: 1.080kg (2lb 6oz)

Retro™

Alum: 0.780kg (1lb 11oz)

Cop: 1.680kg (3lb 11oz)

SS: 1.505kg (3lb 5oz)

## ACCESSORIES

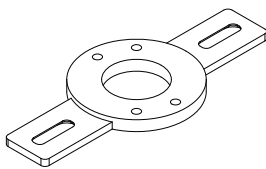

Wall Box Adaptor

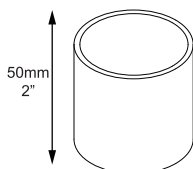

Snoot

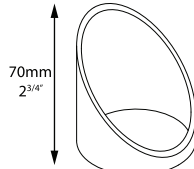

Glare Guard

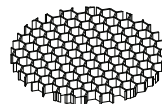

Hex Cell Louvre

## BEAM ANGLES

High efficiency PMMA TIR lenses. Field replaceable

IES files available for download: [hunzalighting.com/downloads](http://hunzalighting.com/downloads)

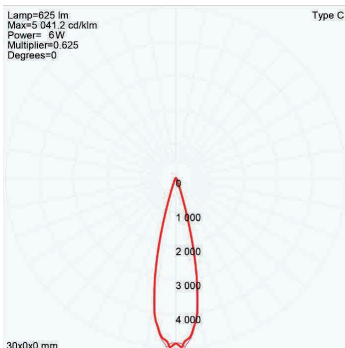

15° FWHM TIR

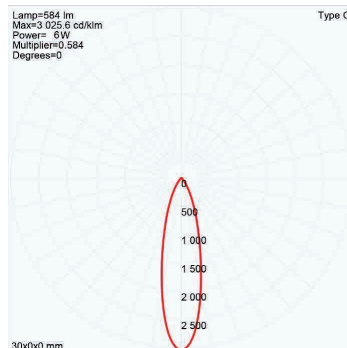

25° FWHM TIR

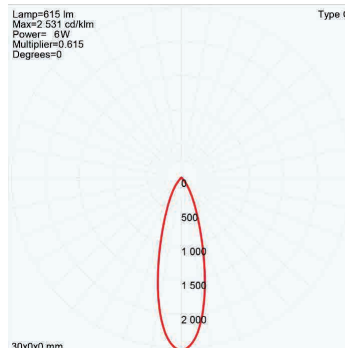

38° FWHM TIR

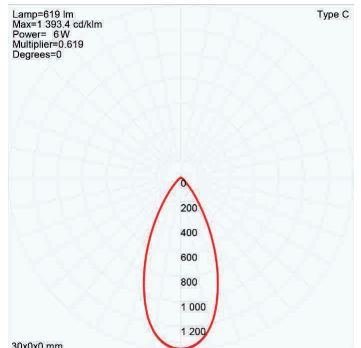

60° FWHM TIR

## WIRING GUIDE

### Series/remote driver

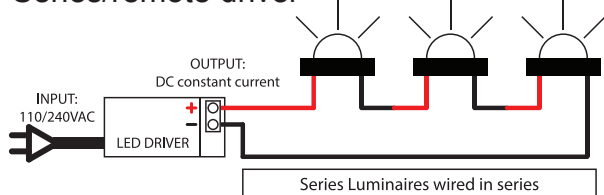

Diagrams are a guide only, wire colours and polarity may change depending on fixture and country

Available for download: [hunzalighting.com/downloads](http://hunzalighting.com/downloads)

### 12v integral driver

