

HL3 3" Square Trim Series

Recessed 3-inch aperture LED downlight / directional with field interchangeable optics provide various distribution patterns. Ideal for accent, task and general area lighting. Housing is airtight, suitable for 2x6 residential or shallow plenum commercial constructions and can be used in direct contact with insulation. Trims are available in a range of finishes and can be installed rimless with an optional rimless adapter. Use where high efficiency, excellent light control and low aperture brightness are required.

Catalog #		Type
Project		
Comments		Date
Prepared by		

DIRECTIONAL OPEN



TLS3R
Square Reflector,
Open, Self Flanged

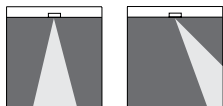

ORDERING INFORMATION

Trim	Shielding	Finish	Flange
TLS3R = 3.25" aperture square reflector, open, self-flanged	[blank] = open	Anodized Finishes H = semi-specular clear reflector and flange HWF = semi-specular clear reflector and matte white flange Electroplated Finishes BN = brushed nickel reflector and flange ORB = oil rubbed bronze reflector and flange Painted Finishes MW = matte white reflector and flange MB = matte black reflector and flange	[blank] = full overlap self-flanged

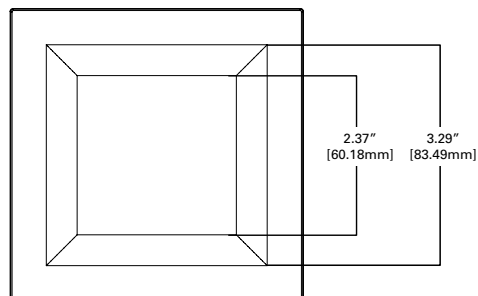
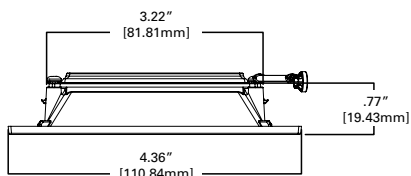

TLS3RMWRL
Square Reflector,
Open, Rimless

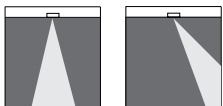

ORDERING INFORMATION

Trim	Shielding	Finish	Flange
TLS3R = 3.25" aperture square reflector, open, rimless	[blank] = open	Painted Finishes MW = matte white reflector and flange	RL = rimless, must be used with rimless adapter ordered separately

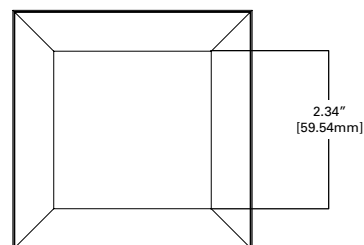
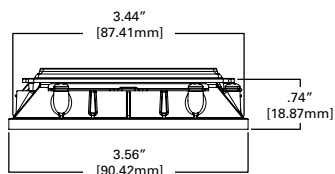

DIRECTIONAL OPEN



TLS3BBWF
TLS3WBWF
Square Baffle,
Open, Self Flanged

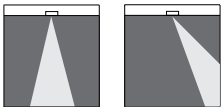

ORDERING INFORMATION

Trim	Shielding	Finish	Flange
TLS3R = 3.25" aperture square baffle, open, self-flanged	[blank] = open	Painted Finishes BBMF = matte black baffle, matte white flange WBWF = matte white baffle, matte white flange	[blank] = full overlap self-flanged

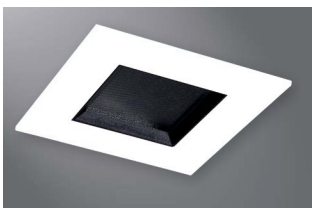
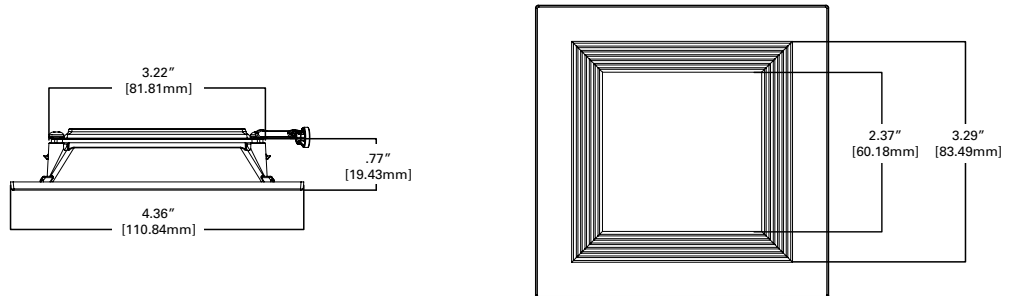

TLS3PIN
Square Pinhole w/Oculus,
Open, Self Flanged

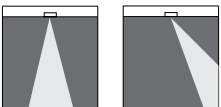

ORDERING INFORMATION

Trim	Shielding	Finish	Flange
TLS3PIN = 2.00" aperture square pinhole w/ oculus, open, self-flanged	[blank] = open	Electroplated Finishes BNBB = brushed nickel flange, black oculus ORBBB = oil rubbed bronze flange, black oculus Painted Finishes MWWB = matte white flange, white oculus MWBB = matte white flange, black oculus MBBB = matte black flange, black oculus	[blank] = full overlap self-flanged

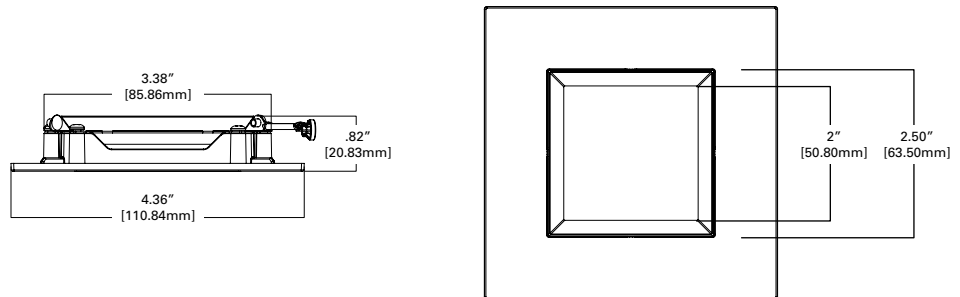

TLS3PINMWWBRL
Square Pinhole w/Oculus,
Open, Rimless

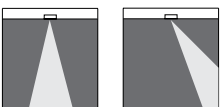

ORDERING INFORMATION

Trim	Shielding	Finish	Flange
TLS3PIN = 2.00" aperture square pinhole w/ oculus, open, rimless	[blank] = open	Painted Finishes MWWB = matte white flange, white oculus	RL = rimless, must be used with rimless adapter ordered separately

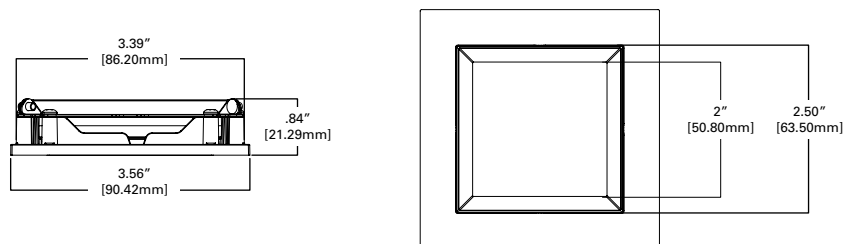

DIRECTIONAL LENS

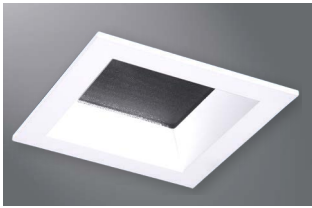

TLS3R2G
Conical Reflector,
Diffuse Lens, Self Flanged

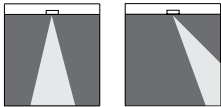

ORDERING INFORMATION

Trim	Shielding	Finish	Flange
TLS3R = 3.25" aperture square reflector, lens, self-flanged	2G = micro-prismatic lens	Anodized Finishes H = semi-specular clear reflector and flange HWF = semi-specular clear reflector and matte white flange Electroplated Finishes BN = brushed nickel reflector and flange ORB = oil rubbed bronze reflector and flange Painted Finishes MW = matte white reflector and flange MB = matte black reflector and flange	[blank] = full overlap self-flanged

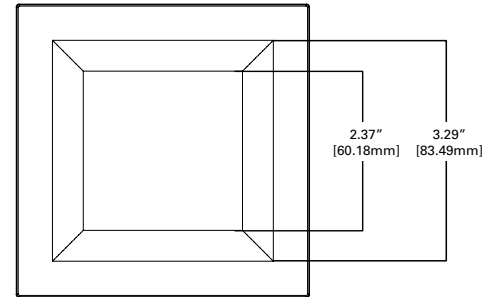
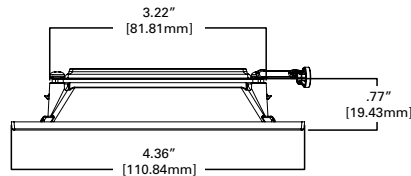

TLS3R2GMWRL
Square Reflector,
Diffuse Lens, Rimless

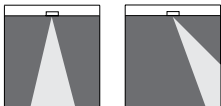

ORDERING INFORMATION

Trim	Shielding	Finish	Flange
TLS3R = 3.25" aperture conical reflector, open, rimless	2G = micro-prismatic lens	Painted Finishes MW = matte white reflector and flange	RL = rimless, must be used with rimless adapter ordered separately

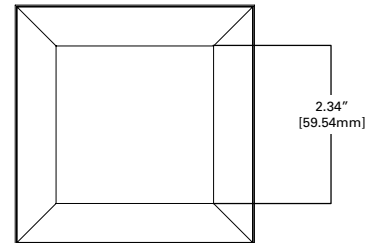
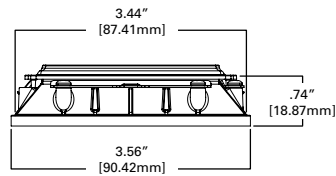

TLS3PR2GMW
Square Polymer Reflector,
Diffuse Lens, Self Flanged

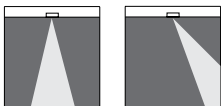

ORDERING INFORMATION

Trim	Shielding	Finish	Flange
TLS3R = 3.25" aperture square polymer reflector, lens, self-flanged	2G = micro-prismatic lens	Painted Finishes MW = matte white reflector and flange	[blank] = full overlap self-flanged

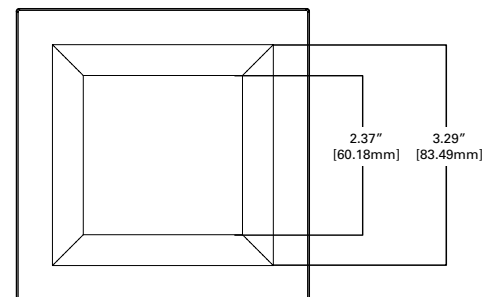
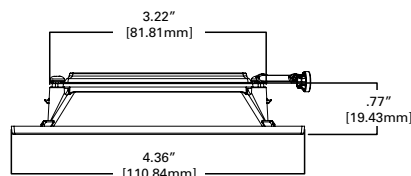

DIRECTIONAL LENS



TLS3R2GBBWF
TLS3R2GWBWF
Square Baffle,
Diffuse Lens, Self Flanged

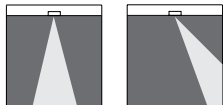

ORDERING INFORMATION

Trim	Shielding	Finish	Flange
TLS3R = 3.25" aperture square baffle, lens, self-flanged	2G = micro-prismatic lens	Painted Finishes BBMF = matte black baffle, matte white flange WBWF = matte white baffle, matte white flange	[blank] = full overlap self-flanged

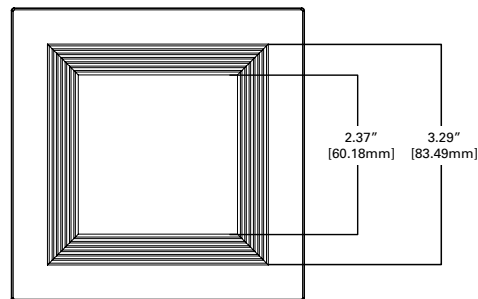
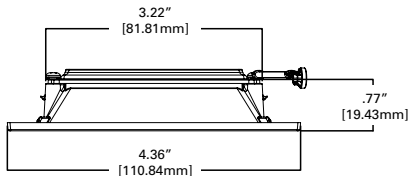

ORDERING INFORMATION

Trim	Shielding	Finish	Flange
TLS3PIN = 2.00" aperture square pinhole w/ oculus, open, self-flanged	2G = micro-prismatic lens	Electroplated Finishes BNBB = brushed nickel flange, black oculus ORBBB = oil rubbed bronze flange, black oculus Painted Finishes MWWB = matte white flange, white oculus MWBB = matte white flange, black oculus MBBB = matte black flange, black oculus	[blank] = full overlap self-flanged

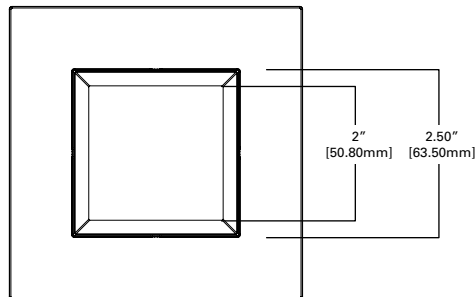
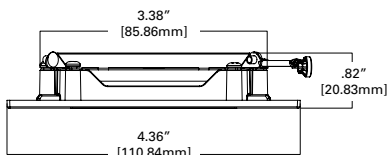

TLS3PIN2G
Square Pinhole w/Oculus,
Diffuse Lens, Self Flanged

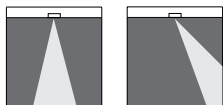

ORDERING INFORMATION

Trim	Shielding	Finish	Flange
TLS3PIN = 2.00" aperture square pinhole w/ oculus, open, rimless	2G = micro-prismatic lens	Painted Finishes MWWB = matte white flange, white oculus	RL = rimless, must be used with rimless adapter ordered separately

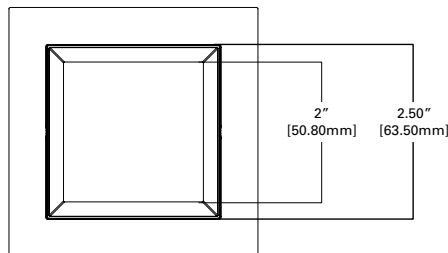
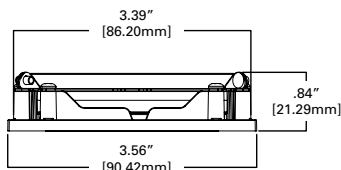

TLS3PIN2G*RL
Square Pinhole w/Oculus,
Diffuse Lens, Rimless

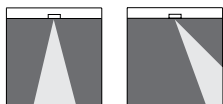

LENS WALL WASH



TLS3LWW6G
Square Angle Cut Lens
Wall Wash, Self Flanged

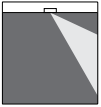

ORDERING INFORMATION

Trim	Shielding	Finish	Flange
TLS3LWW = 3.25" aperture square lens wall wash, self-flanged	6G = linear spread lens	Anodized Finishes H = semi-specular clear reflector and flange HWF = semi-specular clear reflector and matte white flange Painted Finishes MW = matte white reflector and flange	[blank] = full overlap self-flanged

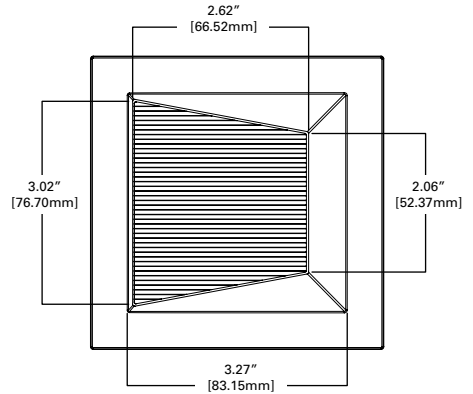
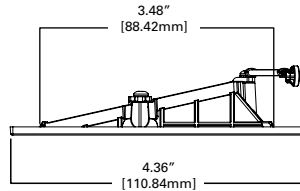

TLS3LWW6GMWRL
Square Angle Cut Lens
Wall Wash, Rimless

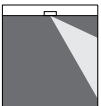

ORDERING INFORMATION

Trim	Shielding	Finish	Flange
TLS3LWW = 3.25" aperture square lens wall wash, rimless	6G = linear spread lens	Painted Finishes MW = matte white reflector and flange	RL = rimless, must be used with rimless adapter ordered separately

