

GARDCO

by **signify**

Solar lighting

SolarForm Gen 2



**An all-in-one
solar solution with style**

Why Gardco for Solar?

Gardco, a trusted brand in outdoor lighting for over 60 years, is unlocking the benefits of solar lighting, a key part of our commitment to sustainability. Utilizing proven technology in use by Signify across the globe, Gardco is excited to bring this solution to North America. We want to empower our customers to move to cleaner technologies and extend their reach into areas where conventional lighting solutions are not possible.

SolarForm is an integrated solar solution with a Lithium Iron Phosphate battery, solar panel, and charger built into the luminaire. It features a die-cast aluminum housing for sturdiness and long life, while offering high brightness illumination with low blackout risk to help pedestrians feel more secure. Optional motion sensors and multiple dimming profiles adjust the lighting based on occupancy, making it a truly sustainable solar lighting solution.

SolarForm benefits:

- All-in-one solution
- Environmentally friendly
- Pleasing aesthetics
- Quick installation
- No trenching

Let Gardco SolarForm luminaire help solve your next lighting challenge. Visit www.gardcolighting.com/solarform to find out more!



Product details



Easy to install

All in one construction, adjustable tilt angles of 0 to 15 degrees, vertical or horizontal tenon, no trenching required.



Long product life plus a sense of security

Sturdy die-cast aluminum construction and LiFePO₄ battery. Reliable outdoor lighting helps make pedestrians feel more secure and may help deter crime.



Save money

Solar solutions mean lower electric bills and can help you take advantage of government rebates and tax incentives.



Environmentally friendly

Solar lighting is extremely clean, with a minimal carbon footprint, helping protect the future of our environment.



Motion sensing

Built in PIR sensor can detect motion to save energy by dimming.



Field Programmable

System status can be monitored, and operating profiles can be set on-site via a Bluetooth App for easy monitoring and control.



High efficacy

High luminous efficacy of 175 lm/Watt to maximize battery performance.



Install almost anywhere

No area is too remote when the power comes from the sun. Ideal for a wide range of applications.

- Residential street lighting
- Military establishments
- Industries
- Schools
- Rural areas
- Parks and pedestrian walkways
- Waterfronts
- Corporate campuses



1 Solar panel

Mono / Poly Crystalline Silicon are used to maximize solar radiation energy and the longevity of the PV.

2 Replaceable battery

Replaceable Lithium Iron Phosphate battery for long life and hassle free operations.

3 Durable construction

One-piece die-cast aluminum housing

4 MPPT charge controller

Highly efficient, integrated microprocessor based MPPT programmable charge controller with driver mounted on the same board to minimize power loss

5 IP65 rated housing

Water, dust, and corrosion resistant to withstand extreme weather conditions, IP65 certified, 1000 hrs salt spray tested

6 Self-diagnostics

Self-diagnostic capabilities with LED indicators for battery charging, discharging & on/off

7 Type 2 optics

Performance tested per LM-79 and TM-15 (IESNA)

8 Motion sensor

Factory set dimming profile along PIR sensor for run time maximization

9 Switch

Master power switch ON/OFF

10 Specialized mounting bracket

Pole mounting bracket with adjustable tilt angles of 0 to 15 degrees, which can be used with vertical or horizontal tenons



Dimensions, distributions, and dimming profiles

SolarForm Gen 2 - Small



SolarForm Gen 2 - Large

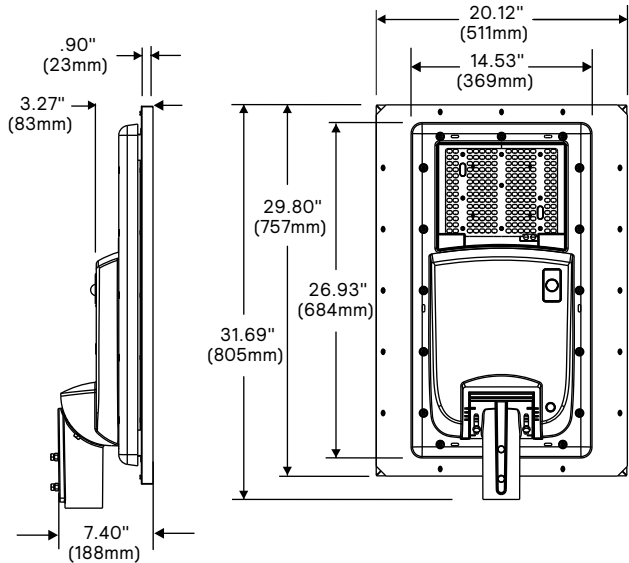
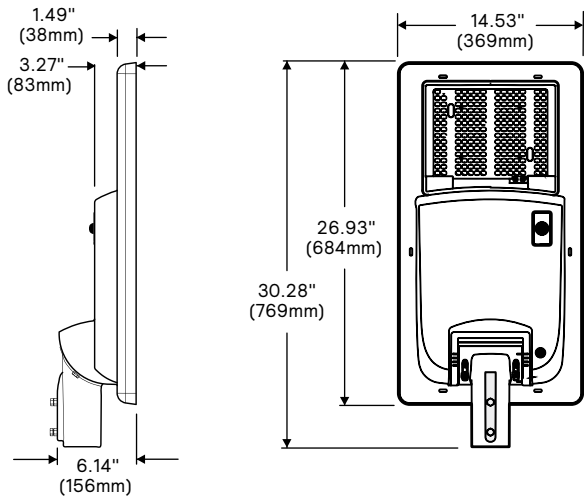

Weight

2000L: 19.8 lbs (9 Kg)
3000L: 23.1 lbs (10.5Kg)

Effective Projected Area (EPA):

2000-3000L: .683 ft² (.063 m²)

Weight

4500L weight: 41.9 lbs (19 Kg)

Effective Projected Area (EPA):

4500L: .832 ft² (.077 m²)

Based on mounting height of 15ft (Dimensions below are in ft)

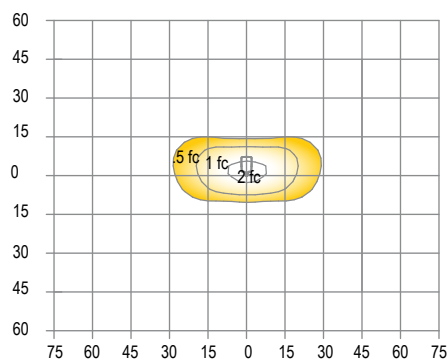

2000 lumen model

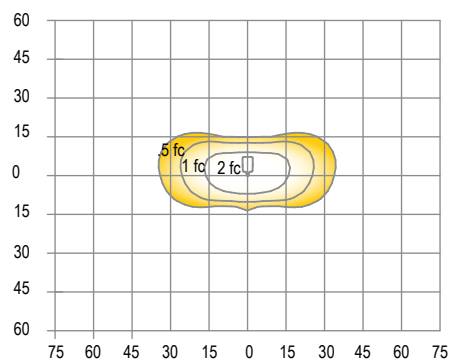

3000 lumen model

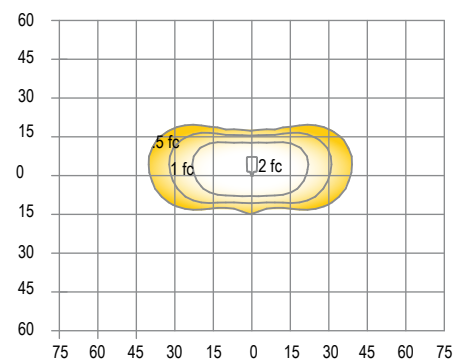

4500 lumen model

FD – Fixed Dimming

FDX01

First 5 hours from dusk light level fixed at **100%**.
 Next 5 hours light level fixed at **30%**.
 Remaining hours to dawn, light level fixed at **100%**.

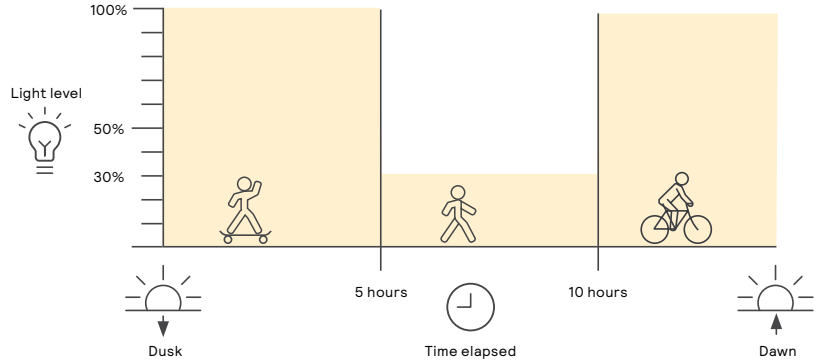

FDX02

First 5 hours from dusk light level fixed at **100%**.
 Next 5 hours light level fixed at **50%**.
 Remaining hours to dawn, light level fixed at **100%**.

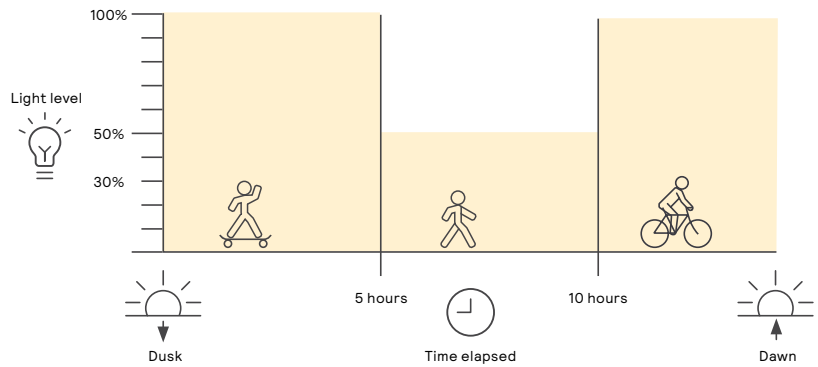

FD530

First 5 hours from dusk light level fixed at **100%**.
 Remaining hours to dawn, light level fixed at **30%**.



FD550

First 5 hours from dusk light level fixed at **100%**.
 Remaining hours to dawn, light level fixed at **50%**.

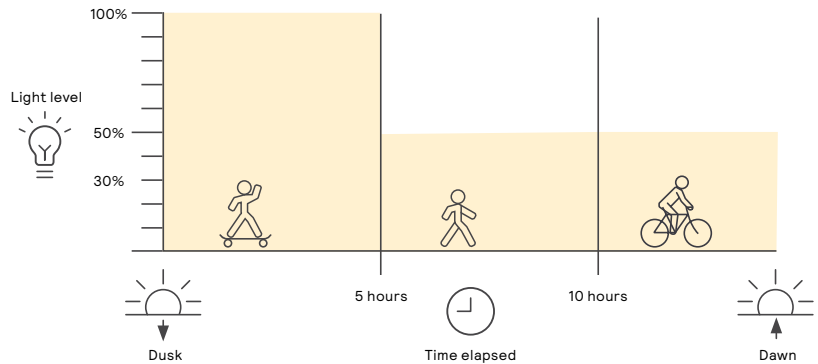

Dimensions, distributions, and dimming profiles

PD - Profile Dimming

PDX01

First 5 hours from dusk light level 100% when motion is detected and 30% when **no motion is detected**.

Next 5 hours, **motion sensor disabled**, and light level fixed at 30%.

Remaining hours to dawn light level at 100% when **motion is detected** and 30% **without motion**.

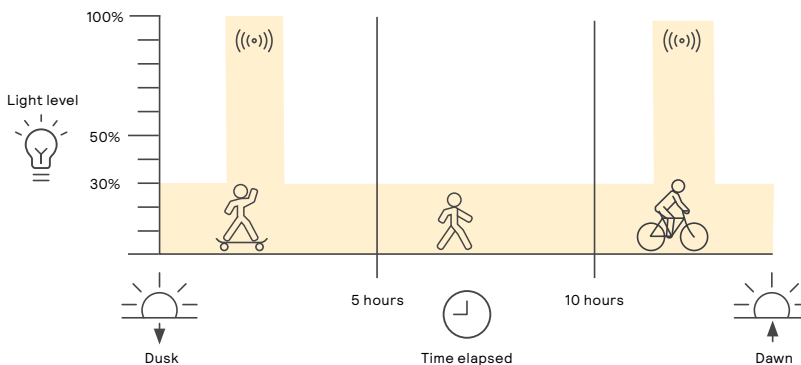

PDX02

First 5 hours from dusk light level 100% when motion is detected and 50% when **no motion is detected**.

Next 5 hours, **motion sensor disabled**, and light level fixed at 50%.

Remaining hours to dawn light level at 100% when **motion is detected** and 50% **without motion**.

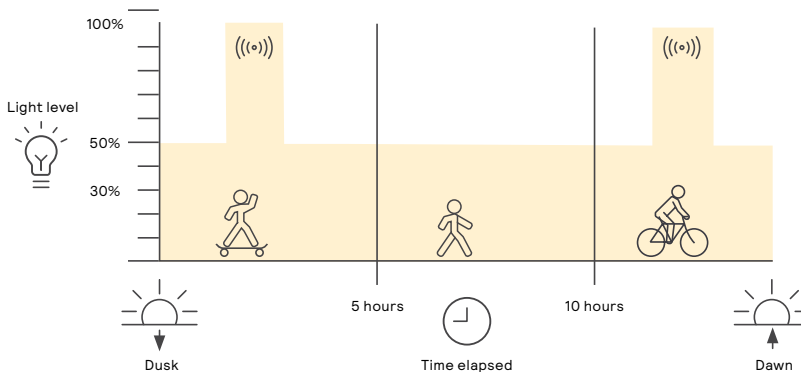

PD30

Dusk to dawn, light level is at 100% with motion and at 30% **without motion**.

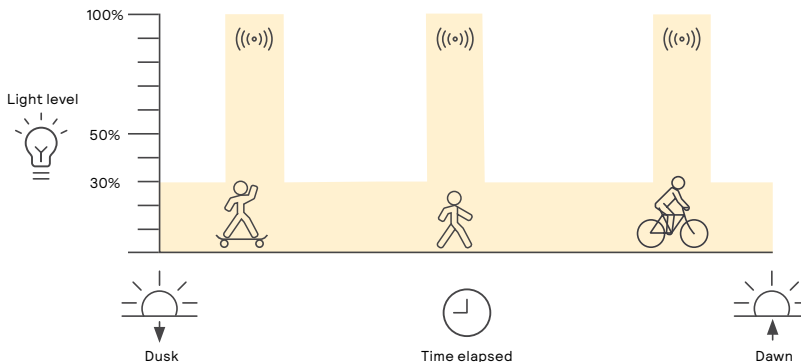

PD50

Dusk to dawn, light level is at 100% with motion and at 50% **without motion**.

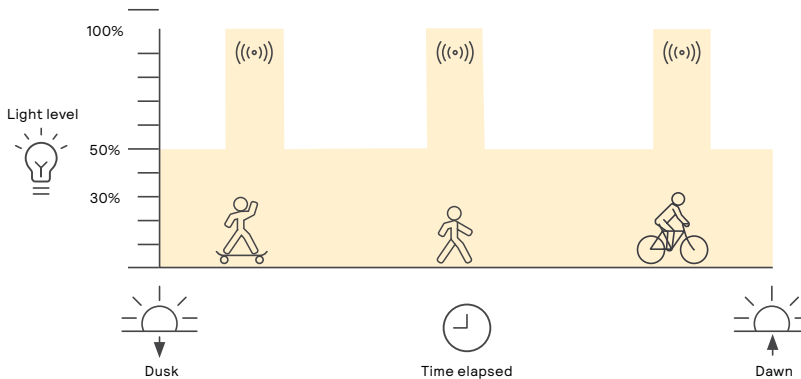

Ordering guides: luminaires

Luminaires

Ordering guide

Prefix	Configuration	LED Color	Distribution	Motion Sensor	Dimming Profile	Battery Capacity	Finish
SOF-S			T2			B256	
SOF-S SolarForm Small (PV Panel 36Wp)	LED20 2000lm LED30 3000lm	730 70 CRI, 3000K 740 70 CRI, 4000K	T2 Type 2	Blank No motion sensor	FDX01 Fixed dimming #1 FDX02 Fixed dimming #2 FD530 Fixed dimming: 100% for 5 hrs then 30% till sunrise FD550 Fixed dimming: 100% for 5 hrs then 50% till sunrise	B256 Battery 256Wh	BK Black WH White BZ Bronze DG Dark grey MG Medium grey RALXXXX RAL color CC Custom color
				MR Motion sensor	PDX01 Profile dimming #1 PDX02 Profile dimming #2 PD30 Profile dimming: 100% with motion override and 30% without PD50 Profile dimming: 100% with motion override and 50% without		

Ordering guide

Prefix	Configuration	LED Color	Distribution	Motion Sensor	Operating Profile	Battery Capacity	Finish
SOF-L			T2			B384	
SOF-L SolarForm Large (PV Panel 60Wp)	LED30 3000lm LED45 4500lm	730 70 CRI, 3000K 740 70 CRI, 4000K	T2 Type 2	Blank No motion sensor	FDX01 Fixed dimming #1 FDX02 Fixed dimming #2 FD530 Fixed dimming: 100% for 5 hrs then 30% till sunrise FD550 Fixed dimming: 100% for 5 hrs then 50% till sunrise	B384 Battery 384Wh	BK Black WH White BZ Bronze DG Dark grey MG Medium grey RALXXXX RAL color CC Custom color
				MR Motion sensor	PDX01 Profile dimming #1 PDX02 Profile dimming #2 PD30 Profile dimming: 100% with motion override and 30% without PD50 Profile dimming: 100% with motion override and 50% without		

Ordering guides: poles and brackets

Poles and Brackets

Ordering guide

example: SSS-CB-4-11-12-T2D6L-N-BK

Family	Base	Pole Size (in.)	Pole Gauge	Height (ft.)	Drilling/Tenon Configuration	Drilling Template	Finish
SSS Straight Square Steel	CB Carbon Steel Base with Base Cover	4	11 11 ga.	10	Horizontal Mounting		BK Black BZ Bronze WH White DG Dark Grey MG Medium Grey
				12	D1 1 Way	DT6 Drill template 6 (requires RLAR brackets, ordered separately)*	
				14	D1@180 1 Way @ 180		
				15	D2 2 Way @ 180		
				16	D2@90 2 Way @ 90		
				18	Vertical Mounting		
				20	T2D6L 2-3/8" OD tenon x 6" length	N No drilling (for tenons)	

* RLAR brackets are to be ordered as a separate accessory, 1 per luminaire: RLAR-1A-SQ4+- (finish)

Ordering guide

example: SSS-CB-4-11-12-T2D6L-N-BK

Family	Base	Pole Size (in.)	Pole Gauge	Height (ft.)	Drilling/Tenon Configuration	Drilling Template	Finish
SRS Straight Round Steel	CB Carbon Steel Base with Base Cover	4	11 11 ga.	10	Horizontal Mounting		BK Black BZ Bronze WH White DG Dark Grey MG Medium Grey
				12	D1 1 Way	DT6 Drill template 6 (requires RLAR brackets, ordered separately)**	
				14	D1@180 1 Way @ 180		
				16	D2 2 Way @ 180		
				20	D2@90 2 Way @ 90		
					Vertical Mounting		
					T2D6L 2-3/8" OD tenon x 6" length	N No drilling (for tenons)	

** RLAR brackets are to be ordered as a separate accessory, 1 per luminaire: RLAR-1A-R4@4.9- (finish) (for 4" Poles)

Horizontal Mounting (requires RLAR brackets, offered separately)

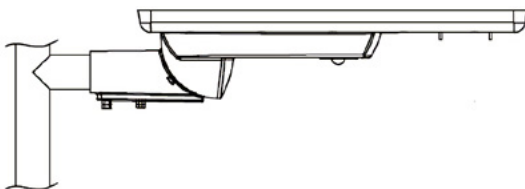

Vertical mounting

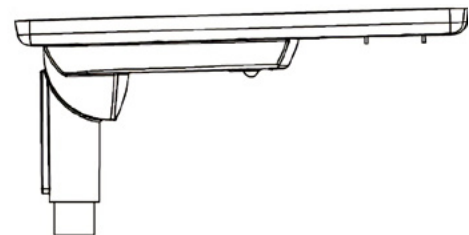

* **Warning:** Additional wind loading, in terms of EPA, from banners, cameras, floodlights and other accessories attached to the pole, must be added to the luminaire(s) EPA before selecting the pole with the appropriate wind load capability. See pole spec sheets for the most up to date EPA data and general design warnings.

† Factory supplied template must be used when setting anchor bolts. Gardco will not honor any claim for incorrect anchorage placement resulting from failure to use factory supplied templates.

Wall mount steel brackets

Wall Mount Steel Brackets

SBRKT-VTN-L1-6-WA-(finish)

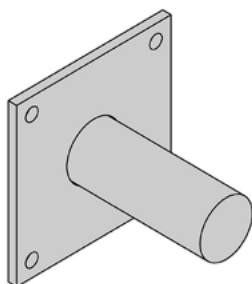

SBRKT-RAH-L1-8.5/8-WA-(finish)

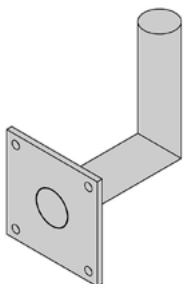

SBRKT-RAH-L1-14/8-WA-(finish)

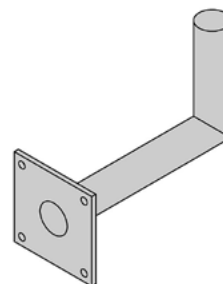

SBRKT-RA-L1-12/13-WA-(finish)

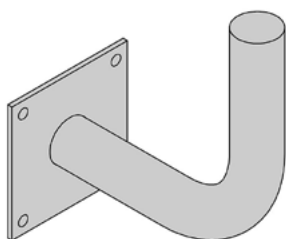

SBRKT-RA-L2-30-WA-(finish)

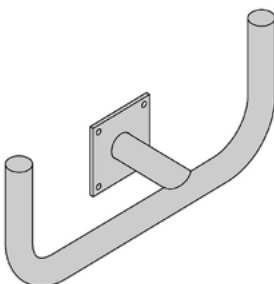

* **Warning:** Additional wind loading, in terms of EPA, from banners, cameras, floodlights and other accessories attached to the pole, must be added to the luminaire(s) EPA before selecting the pole with the appropriate wind load capability. See pole spec sheets for the most up to date EPA data and general design warnings.

† Factory supplied template must be used when setting anchor bolts. Gardco will not honor any claim for incorrect anchorage placement resulting from failure to use factory supplied templates.

