



The Gardco ClearScope LED luminaires feature an architecturally stylish design that will complement your application's visual landscape. ClearScope offers unparalleled photometric performance, significant savings over HID, and is available with the latest in energy saving control options.

Project: _____

Location: _____

Cat.No: _____

Type: _____

Lamps: _____ Qty: _____

Notes: _____

Ordering guide

Example: CSFS-A07-740-A33-SLF-UNV-FAWS-SP2-MG

Luminaire	Configuration (nominal lumens)	Color Temperature	Distribution	Mounting	Voltage	Options				Finish																				
						Dimming Controls ^{1,5}	Fusing	Surge Protection	Other Options																					
CSFS	A01	2,300	730	70CRI	A33	Assymetric 33° Flood (NEMA 6x5)	SLF	Slip Fitter Mount (fits on 2-3/8" to 3" O.D. tenon, wires through slip fitter)	120	120V	None	Leave blank (0-10V dimming driver standard)	None	Leave blank	Blank	10kV / 10kA (standard)	None	Leave blank	BK	Black										
	A02	3,400																			3000K	SPT ⁷	Spot (12° Round)	208	208V	240	240V	277	277V	347
	A03	4,200	740	70CRI	RSP	Rectangular Spot (NEMA 3x3)	TRN ⁸	Trunnion Mount (3.28' or 1m cord exits luminaire)	240	240V	277	277V	347	347V	480	480V	UNV	Universal 120-277V	DLEA ^{1,2,5}	Dimming Leads Externally Accessible (controls by others)	None									
	A04	5,500	4000K	RMF																		Rectangular Medium Flood (NEMA 7x4)	TRN ⁸	Trunnion Mount (3.28' or 1m cord exits luminaire)	277	277V	347	347V	480	480V
	A05	6,300	750		70CRI	RNF	Rectangular Narrow Flood (NEMA 7x5)	TRN ⁸	Trunnion Mount (3.28' or 1m cord exits luminaire)	277	277V	347	347V	480	480V	UNV	Universal 120-277V	DLEA ^{1,2,5}	Dimming Leads Externally Accessible (controls by others)	None	Leave blank									
	A06	7,500	5000K	RNF	Rectangular Narrow Flood (NEMA 7x5)																	TRN ⁸	Trunnion Mount (3.28' or 1m cord exits luminaire)	277	277V	347	347V	480	480V	UNV
	A07	8,700	750			70CRI	RNF	Rectangular Narrow Flood (NEMA 7x5)	TRN ⁸	Trunnion Mount (3.28' or 1m cord exits luminaire)	277	277V	347	347V	480	480V	UNV	Universal 120-277V	DLEA ^{1,2,5}	Dimming Leads Externally Accessible (controls by others)	None									
	A08	11,200		750	70CRI																	RNF	Rectangular Narrow Flood (NEMA 7x5)	TRN ⁸	Trunnion Mount (3.28' or 1m cord exits luminaire)	277	277V	347	347V	480
	A09	12,200	750			70CRI	RNF	Rectangular Narrow Flood (NEMA 7x5)	TRN ⁸	Trunnion Mount (3.28' or 1m cord exits luminaire)	277	277V	347	347V	480	480V	UNV	Universal 120-277V	DLEA ^{1,2,5}	Dimming Leads Externally Accessible (controls by others)	None									
	A10	14,500		750	70CRI																	RNF	Rectangular Narrow Flood (NEMA 7x5)	TRN ⁸	Trunnion Mount (3.28' or 1m cord exits luminaire)	277	277V	347	347V	480

1. Choose only 1 option: either DLEA or FAWS.
2. For DLEA option luminaire has 0-10V dimming wires exiting the luminaire for dimming controls by others.
DLEA not available with PCB or TT5 - choose one of the three options.
3. PCB available with 120V or 208V or 240V or 277V.
4. For Fusing and PCB must specify applicable specific input voltage, not available with UNV or HVU.
5. 0-10V dimming driver standard.
6. Must contact factory prior to ordering - these items are ETO Specials.
7. ICL not available with SPT (does not fit on optical plate).
8. TT5 not available with TRN Trunnion Mount.
9. Use of photoelectric cell (by others) or shorting cap (by others) is required to ensure proper illumination.

Connected lighting

Interact City connector node provides the plug and play wireless communications technology to connect your floodlight to the Interact City lighting management system.



Accessory Ordering Code	Description
LLC	Interact City cellular technology connector node

Contact Signify for additional support when connected lighting or additional services are desired.
For more details visit: <https://www.interact-lighting.com/en-us/what-is-possible/interact-city>



CSFS ClearScape LED floodlight, small

CSFS small floodlight

Accessories¹ – Ordering guide (Ordered separately, field installed, specify finish at placeholder F)

Shielding and Lenses (mounting hardware included)	Mounting – Slip Fitter mount	Mounting – Trunnion mount
WG-CSFS Wire Guard (always chrome finish) SG-CSFS Stone Guard (polycarbonate flat shield) BD-CSFS -BK Barn Doors (Black finish standard)	WMB-16.5-(F) Wall Mounting Bracket SMT-2-(F) Surface Mount Tenon JB-VMT-(F) Junction Box w/ SMT-2	BP-(F) Surface Mount Base Plate

1. Consult Signify to confirm whether specific accessories are BAA-compliant.

Dimensions – ClearScape Small (CSFS)

Slip Fitter Mount

Front view

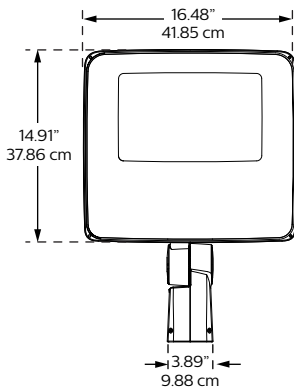

Side view

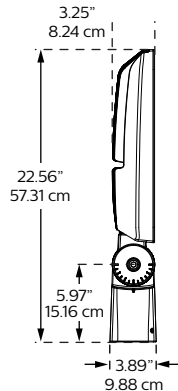

Weight: 31 Lbs (14.1 Kg)

Trunnion Mount

Front view

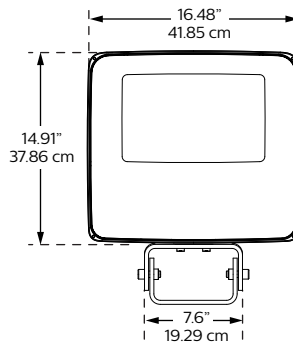

Side view

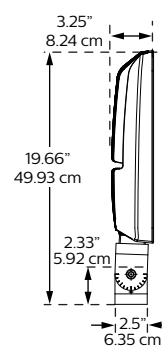

Weight: 29 Lbs (13.2 Kg)

EPA Chart

	Effective Projected Area (EPA-ft ²)		
Mounting	Single: 0° Aim	Single: 45° Aim	Single: 90° Aim
SLF	0.18	1.13	2.07
TRN	0.17	1.12	2.04

Slip Fitter and Trunnion Aiming Diagram

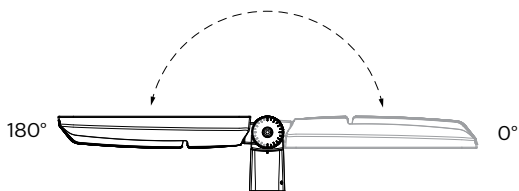

Drill Template – Trunnion Mount

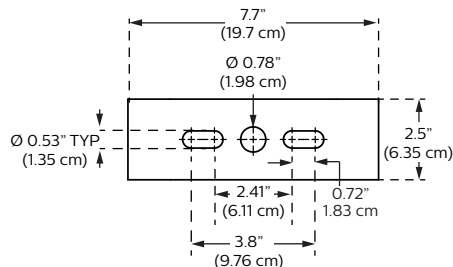

Recommended Bolt Size: 1/2"

CSFS ClearScape LED floodlight, small

CSFS small floodlight

ClearScape Accessories¹ (ordered separately, field installed, specify finish at placeholder F)

Mounting Accessories

For wall and pole brackets, bullhorns, etc. see <https://www.signify.com/en-us/products/outdoor-luminaires/poles-brackets/site-and-area-brackets/bull-horn-brackets#downloads> for details.

Exception: All UPS Upsweep - contact factory to confirm compatibility.

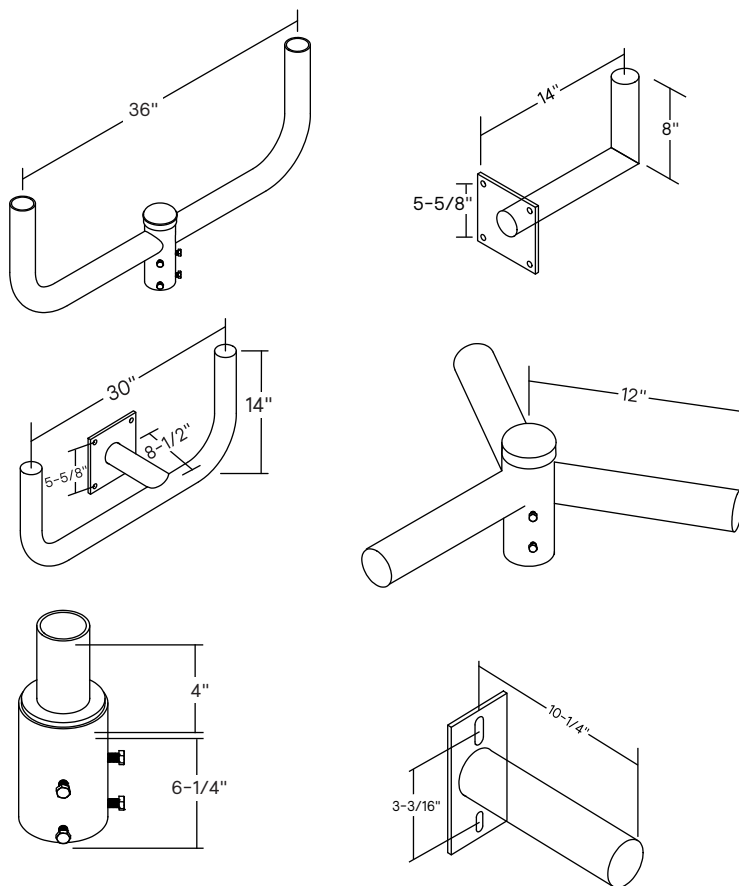

Examples shown are not to scale - see SBRKT spec sheet for all available brackets

1. Consult Signify to confirm whether specific accessories are BAA-compliant.

CSFS ClearScape LED floodlight, small

CSFS small floodlight

Optical Distribution Diagrams

A33 Asymmetric 33° Flood (NEMA 6x5)

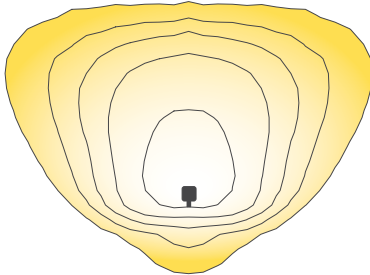

30' or 9.14m mounting height, 30° tilt

Applications include: area lighting, storage yards, transportation terminals, utility sub-stations, large facades, wall washing, large structures/monuments/statues, trees with large canopies.

SPT Spot 12° Round (NEMA 2x2)

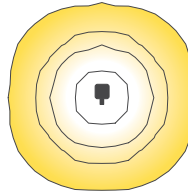

20' or 6.10m setback, 0° tilt

Applications include: flags, tighter spotlighting, accenting, taller columns, tighter scalloping, taller structures/monuments/statues, tallest trees.

RSP Rectangular Spot (NEMA 3x3)

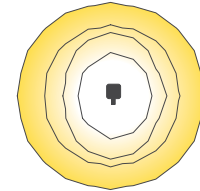

15' or 4.57m setback, 0° tilt

Applications include: flags, spotlighting, accenting, columns, scalloping, structures/monuments/statues, taller trees.

RMF Rectangular Medium Flood (NEMA 7x4)

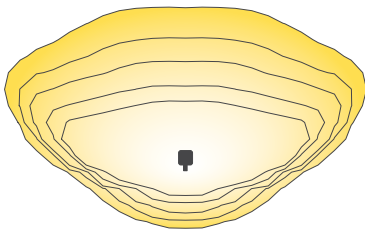

10' or 3.05m setback, 30° tilt

Applications include: building entrances and exits, security lighting, checkpoints and inspection stations, signs, ornamental trees and shrubs

RNF Rectangular Narrow Flood (NEMA 7x5)

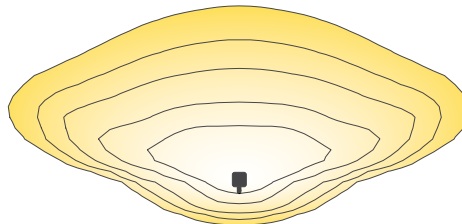

15' or 4.57m setback, 45° tilt

Applications include: facades, wall grazing, signs (especially larger and more rectangular)

Field Adjustable Wattage Selector (FAWS) Multiplier Chart

FAWS Position	Typical Lumens and System Wattage Multiplier
1	25%
2	50%
3	55%
4	65%
5	75%
6	80%
7	85%
8	90%
9	95%
10	100%

NOTE: Actual performance may vary due to LED and driver tolerances.

CSFS ClearScape LED floodlight, small

CSFS small floodlight

Technical Data

Ordering Code	Color Temp.	Avg. System Watts (W)	SPT		RSP		A33		RNF		RMF	
			Lumen Output	Efficacy (LPW)	Lumen Output	Efficacy (LPW)	Lumen Output	Efficacy (LPW)	Lumen Output	Efficacy (LPW)	Lumen Output	Efficacy (LPW)
CSFS-A01-730	3000	20	2,223	113	2,223	113	2,286	116	2,267	115	2,237	114
CSFS-A02-730	3000	29	3,205	112	3,205	112	3,296	116	3,268	115	3,226	113
CSFS-A03-730	3000	37	4,072	109	4,072	109	4,188	113	4,152	112	4,098	110
CSFS-A04-730	3000	48	5,236	108	5,236	108	5,384	111	5,338	110	5,269	109
CSFS-A05-730	3000	57	6,065	107	6,065	107	6,237	110	6,184	109	6,104	108
CSFS-A06-730	3000	65	6,914	106	6,914	106	7,110	109	7,050	109	6,959	107
CSFS-A07-730	3000	71	7,819	110	7,819	110	8,041	113	7,972	112	7,869	110
CSFS-A08-730	3000	90	10,053	112	10,053	112	10,338	115	10,250	114	10,118	113
CSFS-A09-730	3000	103	11,646	113	11,646	113	11,976	116	11,874	115	11,721	114
CSFS-A10-730	3000	118	13,416	114	13,416	114	13,796	117	13,679	116	13,502	114

CSFS-A01-740	4000	20	2,384	121	2,350	119	2,452	124	2,431	123	2,399	122
CSFS-A02-740	4000	29	3,438	121	3,389	119	3,535	124	3,505	123	3,460	121
CSFS-A03-740	4000	37	4,367	117	4,305	116	4,491	121	4,453	120	4,396	118
CSFS-A04-740	4000	48	5,615	116	5,535	115	5,774	119	5,725	118	5,651	117
CSFS-A05-740	4000	57	6,505	115	6,412	113	6,689	118	6,632	117	6,547	116
CSFS-A06-740	4000	65	7,415	114	7,310	113	7,626	117	7,561	116	7,463	115
CSFS-A07-740	4000	71	8,386	118	8,266	116	8,623	121	8,550	120	8,440	118
CSFS-A08-740	4000	90	10,782	120	10,628	118	11,087	123	10,993	122	10,851	121
CSFS-A09-740	4000	103	12,490	121	12,312	120	12,844	125	12,735	124	12,570	122
CSFS-A10-740	4000	118	14,388	122	14,183	120	14,796	125	14,671	124	14,481	123

CSFS-A01-750	5000	20	2,384	121	2,350	119	2,452	124	2,431	123	2,399	122
CSFS-A02-750	5000	29	3,438	121	3,389	119	3,535	124	3,505	123	3,460	121
CSFS-A03-750	5000	37	4,367	117	4,305	116	4,491	121	4,453	120	4,396	118
CSFS-A04-750	5000	48	5,615	116	5,535	115	5,774	119	5,725	118	5,651	117
CSFS-A05-750	5000	57	6,505	115	6,412	113	6,689	118	6,632	117	6,547	116
CSFS-A06-750	5000	65	7,415	114	7,310	113	7,626	117	7,561	116	7,463	115
CSFS-A07-750	5000	71	8,386	118	8,266	116	8,623	121	8,550	120	8,440	118
CSFS-A08-750	5000	90	10,782	120	10,628	118	11,087	123	10,993	122	10,851	121
CSFS-A09-750	5000	103	12,490	121	12,312	120	12,844	125	12,735	124	12,570	122
CSFS-A10-750	5000	118	14,388	122	14,183	120	14,796	125	14,671	124	14,481	123

Values from photometric tests performed in accordance with IESNA LM-79 and are representative of the configurations shown. Actual performance may vary due to installation and environmental variables, LED and driver tolerances, and field measurement considerations. It is highly recommended to confirm performance with a photometric layout.

NOTE: Some data may be scaled based on tests of similar (but not identical) luminaires. Contact factory for configurations not shown.

CSFS ClearScape LED floodlight, small

CSFS small floodlight

Luminaire Option and Accessory details

Barn Doors (BD)

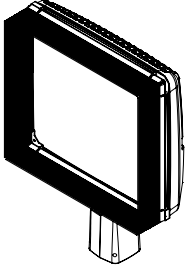

Stone Guard (SG)

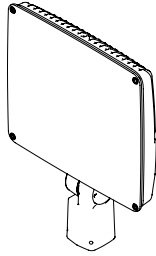

Wire Guard (WG)

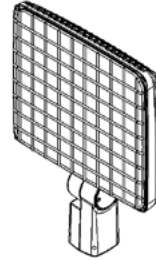

Mounting accessory details - Slip Fitter

WMB-16.5-(F)

Wall Mounting Bracket

2-3/8" O.D. vertical tenon welded to extruded aluminum arm with removable end cap for wiring. Arm is bolted to a cast aluminum plate that has four 5/8" diameter mounting holes.

Suitable for mounting single luminaire only.

Mounting hardware by others.

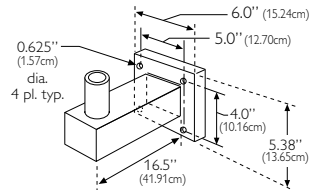

SMT-2-(F)

Surface Mounted Tenon

2-3/8" O.D. aluminum tenon welded to a flat aluminum plate with four 1/2" diameter mounting holes.

Single floodlight may be pad mounted or wall mounted.

Mounting hardware by others.

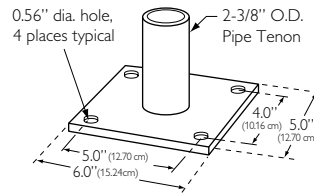

JB-VMT-(F)

Junction Box with SMT-2

For mounting to flat surfaces when using surface mount conduit.

Box has four 1/2" pipe entrances.

1/2" NPS.

Mounting hardware by others.

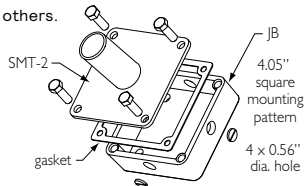

Mounting accessory details - Trunnion Mount

BP-(F) Surface Mount Base Plate

Flat aluminum plate with four 1/2" diameter mounting holes. Single floodlight may be pad mounted or wall mounted. Mounting hardware by others.

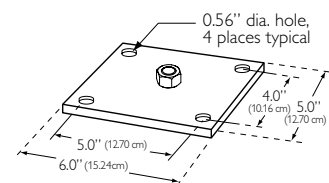

CSFS ClearScape LED floodlight, small

CSFS small floodlight

Specifications

Housing and Heat Sink

Single piece low copper die cast Aluminum alloy (A413) for high resistance to corrosion, low profile for a sleek design with low EPA. Housing also acts as heat sink, designed to ensure high efficacy and superior cooling by natural convection. Integral cast-in heat sink fins are oriented vertically to discourage debris accumulation and promote self-cleaning, further improving heat dissipation. Air flow pattern always close to LEDs and driver optimizing their efficiency and life. Does not use any cooling device with moving parts (only passive cooling).

Mounting

Up tilt aiming and down tilt aiming possible with both mounting options. cULus Listed as suitable for mounting within 4' or 1.2m of the ground.

SLF: Adjustable Slip Fitter with AWG 16-3 wires exiting through the Slip Fitter. Integral splice compartment for field wiring with cULus Wet Location rated access cover with seal around entire perimeter. Slip Fitter made of low copper die cast Aluminum alloy (A360) for high resistance to corrosion, adjustable knuckle has 5 degree aiming increments with integral interlocking teeth and bolt to secure aiming in place, integral cast-in aiming marks. Fits on a range of tenons from 2-3/8" to 3" (60.3mm to 76.2mm) O.D.

TRN: Adjustable Trunnion with 3.28' (1m) of AWG 16-3 STOOV cord (or AWG 16-5 if DLEA external control option is selected) exiting the luminaire through IP66 rated cord seal. Trunnion made of high strength steel, galvanized and painted for high resistance to corrosion, wide range of adjustment (no minimum aiming increments) with bolts and lock washers to secure aiming in place, integral aiming marks every 15 degrees.

IP Rating

IP66 rated luminaire in all aiming positions including up tilt aiming per ANSI C136.37 with seal around entire perimeter of the lens and seal around entire perimeter of the electrical / driver compartment. IP66 rating includes when PCB or TT5 NEMA twist-lock options are installed.

Lens

Single piece heat and impact resistant flat soda-lime tempered glass lens that provides an all-glass edge-to-edge front for a modern design aesthetic. Clear glass in front of LED light engines with black silk screen on inside of remaining lens surface to minimize glare and provide uniform visual transition to the housing. Single piece molded silicone gasket around entire perimeter overlaps securely on housing rib with optimum compression from lens forming IP66 seal. Captive corrosion resistant stainless-steel screws enable removal of lens if required to access electrical components, black oxide screws visually blend in with lens' black silk screen. Ceramic washers cushion screws against glass lens and help ensure proper gasket compression for reliable seal. Lens secured with tether to prevent accidental dropping or disengagement.

IK Rating

IK07 high impact resistance rating for lens.

Light Engine

Composed of 3 main components: LED Module, Optical System, Driver. Electrical components are RoHS compliant. LEDs tested by ISO 17025 2005 accredited lab in accordance with IESNA LM-80 guidelines, extrapolations in accordance with IESNA TM-21. Metal core board ensures greater heat transfer and longer lifespan.

LED Module: Composed of high performance white LEDs. Color temperature as per ANSI/NEMA bin 3000K nominal (3045K +/-175K) or 4000K nominal (3985K +/- 275K) or 5000K nominal (5029K +/- 283K), all CRI 70 min. / 75 typical.

Optical System: Composed of high performance UV stabilized optical grade polymer refractor lenses to achieve desired distribution optimized to get maximum spacing, target lumens and a superior lighting uniformity. Performance shall be tested per LM-63, LM-79 and TM-15 (IESNA) certifying its photometric performance.

Driver: High power factor of 90% min. Electronic driver, operating range 50/60 Hz. Auto adjusting universal voltage input from 120 to 277 or 347 to 480 VAC rated for both application line to line or line to neutral, Class I, THD of 20% max. The current supplying the LEDs will be reduced by the driver if the driver experiences internal overheating as a protection to the LEDs and the electrical components. Output is protected from short circuits, voltage overload and current overload. Automatic recovery after correction. Standard built in driver surge protection of 2.5kV (min). Driver enables setting LED drive current to meet your specific total wattage, lumen output and/or efficacy needs - ETO Specials, contact factory.

Integrated Features

Please note these integrated features always come with luminaire standard at no additional cost. 0-10V dimming driver included as standard, dimming leads pre-wired to Dimming Controls options except when DLEA external controls option is selected.

SP1: Surge protection device tested in accordance with ANSI/IEEE C62.45 per ANSI/IEEE C62.41.2 Scenario I Category C High Exposure 10kV/10kA waveforms for Line-Ground, Line-Neutral and Neutral-Ground. Enhanced surge protection device SP2 20kV/10kA available as an option. Surge protection device wired in parallel so that if it fails open the luminaire will remain lit/powerd on.

Controls Options

Please note that other controls can be integrated as ETO Specials - contact factory.

DLEA: 0-10V dimming driver's dimming wires are externally accessible for connecting dimming controls by others.

FAWS: Field Adjustable Wattage Selector, pre-set to the highest position, can be easily switched in the field to the required position. This reduces total luminaire wattage consumption and light level - see FAWS multiplier chart for more details.

Note: It is not recommended to use FAWS with other dimming or controls; if you do, set the switch to position 10 (maximum output) to enable the other dimming or controls. Switching FAWS to any position other than 10 will disable the other dimming or controls.

Connected Lighting

Interact City connector node provides the plug and play wireless communications technology to

connect your floodlight to the Interact City lighting management system. With Interact you can remotely manage, monitor and control all city lighting, from roads and streets, to parks and plazas, and bridges from one single system. Connected lighting enables capabilities including, accurate on/off switching, dimming control, fault reporting and integration with other systems to enable condition-based lighting. Interact provides you with a robust and scalable infrastructure to further reduce energy consumption, improve operations, and turn lighting into a connected network for your smart city journey.

For more details visit: <https://www.interact-lighting.com/en-us/what-is-possible/interact-city>

Luminaire Options

FS1: Fusing, single (120, 277 or 347VAC) installed in electrical compartment

FS2: Fusing, double (208, 240 or 480VAC) installed in electrical compartment

FS3: Fusing, Canadian Double Pole (208, 240 or 480VAC) installed in electrical compartment.

SP2: 20kV / 10kA surge protection device that provides extra protection beyond the standard SP1 10kV/10kA level. Surge protection device wired in parallel so that if it fails open the luminaire will remain lit/powerd on.

PCB: Photocell Button (a.k.a. button photoeye).

ICL: Internal Concentric Glare Louver reduces glare and increases visual comfort. Shields are installed internally in the factory and do not disrupt the overall aesthetic of the luminaire. ICL not available with SPT optic (does not fit).

TT5*: Tool Less orientable twist-lock receptacle with 5 pins enabling dimming, can be used with an Interact City node, a twist-lock photoelectric cell or a shorting cap. TT5 not available with TRN Trunnion.*Use of photoelectric cell or shorting cap is required to ensure proper illumination.

Luminaire Useful Life

Refer to IES files for energy consumption and delivered lumens for each option. Based on ISTMT in situ thermal testing in accordance with UL1598 and UL8750, exclusive Signify System Reliability Tool, Advance driver data and LED manufacturer LM-80/ TM-21 data, expected to reach 100,000 + hours with L70 lumen maintenance @ 25°C. Luminaire Useful Life accounts for LED lumen maintenance AND all these additional factors including: LED color shift, LED life, driver life, PCB substrate, solder joints, on/off cycles, burning hours and corrosion.

Wiring

#16 AWG wires from the primary circuit, located inside the housing. Due to the inrush current that occurs with electronic drivers, recommend using a time-delay or slow blow fuse to avoid unwanted fuse blowing (false tripping) that can occur with normal or fast acting fuses.

Hardware and Seals

All exposed hardware shall be stainless steel and/or corrosion resistant and captive. All seals and sealing devices are made and/or lined with EPDM and/or silicone and/or rubber.

CSFS ClearScape LED floodlight, small

CSFS small floodlight

Specifications (cont.)

Finish

Color in accordance with the AAMA 2604 standard. Application of polyester powder coat paint (2.5 mils/62.5 microns) with +/- 1 mils/24 microns of tolerance. The thermosetting resins provides a discoloration resistant finish in accordance with the ASTM D2244 standard, as well as luster retention in keeping with the ASTM D523 standard and humidity proof in accordance with the ASTM D2247 standard. The surface treatment achieves a minimum of 1000 hours for salt spray corrosion resistant finish in accordance with the ASTM B117 standard. RAL and custom color matching available - must contact factory prior to ordering, these are ETO Specials.

LED Products Manufacturing Standard

The electronic components sensitive to electrostatic discharge (ESD) such as light emitting diodes (LEDs) are assembled in compliance with IEC61340-5-1 and ANSI/ESD S20.20 standards to eliminate ESD events that could decrease the useful life of the product.

Vibration Resistance

Luminaire meets the ANSI C136.31-2018 specifications for Bridge / Overpass for both Slip Fitter and Trunnion, tested by independent lab over 100,000 cycles in all three axes.

Certifications and Compliance

cULus Listed for Canada and USA, per UL1598 and UL8750, including suitable for mounting within 4' or 1.2m of the ground. Configurations

are DesignLights Consortium qualified, consult DLC QPL Qualified Products List for more details. Luminaire complies with or exceeds the following ANSI C136 standards: .2, .3, .10, .15, .21, .22, .24, .25, .31, .32, .37, .41. Entire luminaire is rated for operation in ambient temperature of -40°C (-40°F) up to +40°C (+104°F). Controls options enable compliance with Outdoor lighting energy codes including ASHRAE 90.1, California Title 24, and IECC.

Limited Warranty

5-year limited warranty. See signify.com/warranties for details and restrictions.

Predicted Lumen Depreciation Data

Ambient Temperature °C	Drive Current	Calculated L ₇₀ Hours	L ₇₀ Per TM-21	Lumen Maintenance % @ 60,000 hours
25°C	up to 1200 mA	>100,000 hours	>60,000 hours	99%

Predicted performance derived from LED manufacturer's data and engineering design estimates, based on IESNA LM-80 methodology. Actual experience may vary due to field application conditions. L₇₀ is the predicted time when LED performance depreciates to 70% of initial lumen output. Calculated per IESNA TM21-11. Published L₇₀ hours limited to 6 times actual LED test hours.

Buy American Act of 1933 (BAA):

This product is manufactured in one of our US factories and, as of the date of this document, this product was considered a commercially available off-the-shelf (COTS) item meeting the requirements of the BAA. This BAA designation hereunder does not address (i) the applicability of, or availability of a waiver under, the Trade Agreements Act, or (ii) the "Buy America" domestic content requirements imposed on states, localities, and other non-federal entities as a condition of receiving funds administered by the Department of Transportation or other federal agencies. Prior to ordering, please visit www.signify.com/baa to view a current list of BAA-compliant products to confirm this product's current compliance.

