

SEE PERFORMANCE CHART ON PAGE 2

STANDARD FINISHES

Black, White, & Silver

SPECIAL FINISH COLORS - Longer Lead Time



Orange, Forest Green, Bronze, Moss Green, Slate Gray, Blue, Red, Yellow

LUX | ENABLED

Suitable for Damp Locations

UL CERTIFIED SAFETY US-CA

5 YEAR WARRANTY

MADE IN U.S.A.

LIGHT LOSS FACTOR		
CCT	CRI	%
4000K	84+	100%
3500K	84+	97.1%
3000K	84+	95.7%
2700K	84+	94.1%
4000K	92+	88.9%
3500K	92+	85.5%
3000K	92+	83.8%
2700K	92+	82.4%

ORDER GUIDE

A	B	C	D	E	F	G	H	I	J	K	L	M
---	---	---	---	---	---	---	---	---	---	---	---	---

EXAMPLE: FLKs.4-P-D | DLAM | 500 | 6 | 27K | 9 | UNV | SI | W | W | HC | 24 | WC | EB

OPTIONS

N (Multiple Selections)

A. MODEL	B. DISTRIBUTION	C. DIRECT OUTPUT				D. LUMINAIRE LENGTHS
FLKs.4 -P-D	DLAM	100% Direct-Lambertian	300	318 lm/ft	(D-318)	2 2 ft (24 in) 3 3 ft (36 in) 4 4 ft (48 in) 5 5 ft (60 in) 6 6 ft (72 in) FRUN System Run Length total footage Pattern FLS FLKs.4 Straight-L FTY FLKs.4 T-Y FX FLKs.4 X FSR FLKs.4 Square-Rectangle FSR(X) AxBxCxDxExFxG... FH FLKs.4 Hex FG FLKs.4 Octagon FCC Custom Pattern - Sketch or Drawing Always Required Multiple Links
	DBAT	100% Direct-Batwing	300	320 lm/ft	(D-320)	
			500	531 lm/ft	(D-531)	
			700	737 lm/ft	(D-737)	
			800	843 lm/ft	(D-843)	
			1000	1059 lm/ft	(D-1059)	
			300	320 lm/ft	(D-320)	
			500	535 lm/ft	(D-535)	
			700	741 lm/ft	(D-741)	
			800	844 lm/ft	(D-844)	
			1000	1062 lm/ft	(D-1062)	

NOTES: Please see Pattern Guide on p.2 for further details. More length options. Individuals only available in 2, 3, 4, 5 and 6 footers.

E. COLOR TEMPERATURE	F. CRI	G. VOLTAGE	H. DRIVER	I. HOUSING FINISH	J. END CAP/HUB FINISH
27K 2700K 30K 3000K 35K 3500K 40K 4000K	8 80+CRI 9 90+CRI	UNV 120-277v 347 347v	S1 1% Dimming (0-10v) LDE1 Lutron Hi-Lume 1% ELO 0.1% EldoLED DXL 1% Dexas	Standard W White B Black S Silver Special (Longer Lead Time) LC LUX MG Moss Orange Green BZ Bronze BL Blue SG Slate RD Red Gray CC Custom Color YW Yellow FG Forest Green	Standard W White B Black S Silver Special (Longer Lead Time) LC LUX MG Moss Orange Green BZ Bronze BL Blue SG Slate RD Red Gray CC Custom Color YW Yellow FG Forest Green
	90 CRI option has an R9 value greater than 60.	347 may not be available in all configurations.		See page 3 for more information on finishes. Consult factory for custom colors. (Power feeds and canopies excluded)	See page 3 for more information on finishes. Consult factory for custom colors.

OPTIONS

K. MOUNTING TYPE	L. SUSPENSION LENGTH	M. CANOPIES	N. CONTROLS & FACTORY OPTIONS
HC Ceiling Mount Into J Box	24 24 in 42 42 in 102 102 in 150 150 in	WC White Canopy BC Black Canopy SC Silver Canopy	AWNR-W Lutron Athena Wireless Node (RF-only) in White AWNR-B Lutron Athena Wireless Node (RF-only) in Black EB Emergency Battery (10 -Watt)

Each power over cable must terminate into a junction box. Each individual suspension length is adjustable. Select feed and canopy choice. Emergency battery is remote only. Emergency test switch is remote mounted by contractor. May choose more than one option in this category.

DLAM

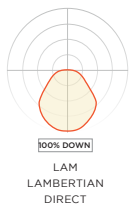

UP TO 106 lm/W PERFORMANCE					
DELIVERED LUMENS (PER 4ft)	4237	3372	2947	2122	1271
ORDER CODE	1000	800	700	500	300
LUMENS PER FT. 100% DOWN	1059	843	737	531	318
WATTS PER FOOT	9.98	7.90	6.90	4.98	3.20
EFFICACY (lm/W)	106.2	106.7	106.8	106.6	99.3
CALCULATED L80 (h)	80,000				
Performance based on 4-foot luminaire at 4,000K @ 25-degrees C					

DBAT

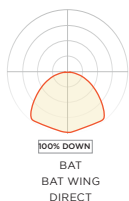

UP TO 108 lm/W PERFORMANCE					
DELIVERED LUMENS (PER 4ft)	4248	3374	2963	2140	1280
ORDER CODE	1000	800	700	500	300
LUMENS PER FT. 100% DOWN	1062	844	741	535	320
WATTS PER FOOT	9.98	7.90	6.90	4.98	3.20
EFFICACY (lm/W)	106.5	106.8	107.4	108.1	100.1
CALCULATED L80 (h)	80,000				
Performance based on 4-foot luminaire at 4,000K @ 25-degrees C					

LIGHT SOURCE

Long life name brand LED chips and boards to ensure the highest of quality while providing even and smooth illumination throughout our luminaires.

Our luminaires are available in 2700K, 3000K, 3500K and 4000K color temperature .

Optional 80CRI or 90CRI available in all CCT options.

LUMEN MAINTENANCE

The projected lumen maintenance of the name brand mid-powered LED's are projected to maintain 80% (L80) of their initial output for +80,000 hours.

CONSTRUCTION

The housings are constructed of (6063T5) extruded aluminum. Our internal joiner system is designed to the highest of standards to ensure our precision cut housings align and fit tightly without light leak. Our precision fitting end caps are constructed out of die cast aluminum.

FINISH

Polyester powder, low gloss textured paint finish applied after a multi-stage pretreatment. Standard luminaire finishes include white, silver, and black. Custom color options are available. (Consult Factory).

INDIVIDUAL STRAIGHT

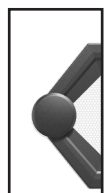

ENDS



OPTICS

Anidolic Light Guide Technology; Direct Lambertian or Batwing Distribution.

DRIVERS (REMOTE)

All of our luminaires come standard with 1% dimming and THD <20% utilizing 0-10v constant current protocol. 120v/277v is standard with the option of 347v. For maximum remote distance see chart below.

EMERGENCY

An integral factory installed 10 watt emergency battery pack is contained in the remote driver enclosure. Emergency circuit and Night Light circuit capable by connecting to appropriate circuit in the field.

LUMINAIRE LENGTH

Our FLKs.4 Pendant Direct Indirect luminaire series are available in 2',3',4',5' & 6' individual panel lengths or continuous row configurations. Continuous row configurations are joined together on-site utilizing the joiner kits provided.

LUMINAIRE WEIGHT

The approximate weight of a four foot luminaire is 4lbs Including end caps assembled.

LUMINAIRE SUSPENSION

The FLKs.4 features Power Over Cable suspension featuring a kevlar jacketed cable and is field adjustable.

INDIVIDUAL UNITS WEIGHTS	
Luminaire	Weight
2 Foot Unit	2lbs
3 Foot Unit	3lbs
4 Foot Unit	4lbs
5 Foot Unit	5lbs
6 Foot Unit	6lbs

Remote Driver Distance	
Wire Size	Distance
22 AWG	18 feet
20 AWG	29 feet
18 AWG	46 feet
16 AWG	74 feet
14 AWG	95 feet

Distance is a maximum based on an assumption of a 1V drop across the full distance

PATTERN GUIDE

W. FLKs.4 PATTERN		X. PATTERN DIMENSIONS
FRUN	System Run Lengths. Total Footage	AxBxCxD...
FSL	FLKs.4 Straight-L (90-180° - Hub Setting 90°- 0°) - See Pattern Guide on p.3 for further details.	AxB
FTY	FLKs.4 T-Y (90-135°- Hub Setting 90°- 45°) - See Pattern Guide on p.4 for further details.	AxBxC
FX	FLKs.4 X (90°) - See Pattern Guide on p.5 for further details.	AxBxCxD
FSR	FLKs.4 Square-Rectangle (90°) - See Pattern Guide on p.6 for further details.	AxBxCxDxE
FSR(X)	Multiple FLKs.4 Square-Rectangle (90° & 180°) - See Pattern Guide on p.6 for further details.	AxBxCxDxExFxG...
FH	FLKs.4 Hex (120° - Hub Setting 60°) - See Pattern Guide on p.7 for further details.	AxBxCxDxExF
FG	FLKs.4 Octagon (135° - Hub Setting 45°) - See Pattern Guide on p.7 for further details.	AxBxCxDxExFxGxH
FCC	Custom Pattern - Sketch or Drawing Always Required	

CONTINUOUS RUN ORDER GUIDES

Please use the following run guides for fixture ordering. If your product will require a submittal, our in-house Application Engineering Team will work closely with you on your project. These are our suggested standard run configurations. Alternate options available, consult factory.

GUIDE

W. FLKs.4	X. PATTERN DIMENSIONS
FRUN	System Run Length / Total footage

ALUMINUM PRODUCT ORDER GUIDE

RUN LENGTH (ft)	RUN CONFIGURATION - SECTION LENGTHS	RUN LENGTH (ft)	RUN CONFIGURATION - SECTION LENGTHS
7	4' + 3'	29	6' + 6' + 6' + 6' + 5'
8	4' + 4'	30	6' + 6' + 6' + 6' + 6'
9	5' + 4'	31	6' + 5' + 5' + 5' + 5' + 5'
10	5' + 5'	32	6' + 5' + 5' + 5' + 5' + 6'
11	6' + 5'	33	6' + 6' + 6' + 5' + 5' + 5'
12	6' + 6'	34	5' + 6' + 6' + 6' + 6' + 5'
13	5' + 3' + 5'	35	6' + 6' + 6' + 6' + 6' + 5'
14	5' + 4' + 5'	36	6' + 6' + 6' + 6' + 6' + 6'
15	5' + 5' + 5'	37	6' + 5' + 5' + 5' + 5' + 5' + 6'
16	4' + 4' + 4' + 4'	38	4' + 6' + 6' + 6' + 6' + 6' + 4'
17	6' + 5' + 6'	39	5' + 6' + 6' + 6' + 6' + 6' + 4'
18	6' + 6' + 6'	40	6' + 6' + 6' + 4' + 6' + 6' + 6'
19	5' + 5' + 5' + 4'	41	6' + 6' + 6' + 5' + 6' + 6' + 6'
20	5' + 5' + 5' + 5'	42	6' + 6' + 6' + 6' + 6' + 6' + 6'
21	6' + 5' + 5' + 5'	43	4' + 6' + 6' + 6' + 6' + 6' + 6' + 3'
22	6' + 5' + 5' + 6'	44	4' + 6' + 6' + 6' + 6' + 6' + 6' + 4'
23	6' + 6' + 6' + 5'	45	5' + 6' + 6' + 6' + 6' + 6' + 6' + 4'
24	6' + 6' + 6' + 6'	46	5' + 6' + 6' + 6' + 6' + 6' + 6' + 5'
25	5' + 5' + 5' + 5' + 5'	47	6' + 6' + 6' + 6' + 6' + 6' + 6' + 5'
26	6' + 5' + 5' + 5' + 5'	48	6' + 6' + 6' + 6' + 6' + 6' + 6' + 6'
27	6' + 5' + 5' + 5' + 6'	49	4' + 6' + 6' + 6' + 6' + 6' + 6' + 6' + 3'
28	5' + 6' + 6' + 6' + 5'	50	4' + 6' + 6' + 6' + 6' + 6' + 6' + 6' + 4'

*Standard Run Configurations Shown, Consult Factory for Custom Configurations.

STANDARD PATTERNS

Individual Flex Horizontal Line 2, 3, 4, 5, 6 ft lengths.

PATTERN GUIDE

W. FLKs.4 PATTERN

FSL

FLKs.4 Straight-L
(90-180° - Hub Setting 90°- 0°)

X. PATTERN DIMENSIONS

AxB

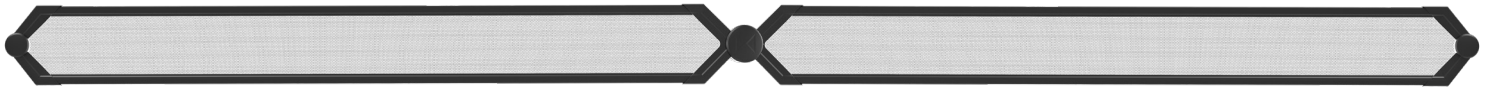

TWO ARM ROTATIONAL HUB

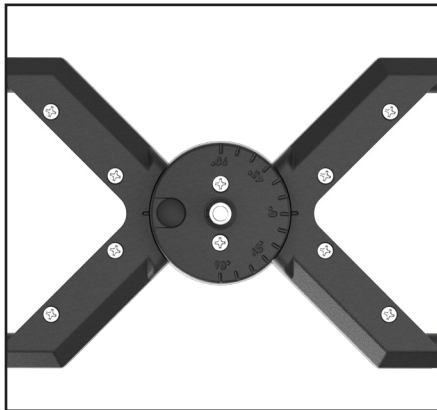

CLOSE UP OF ROTATIONAL HUB

FSL (Straight to L Pattern) is field adjustable in 15° increments from 180° to 90°. FSL Pattern shown is straight 180°, Hub setting 0°.

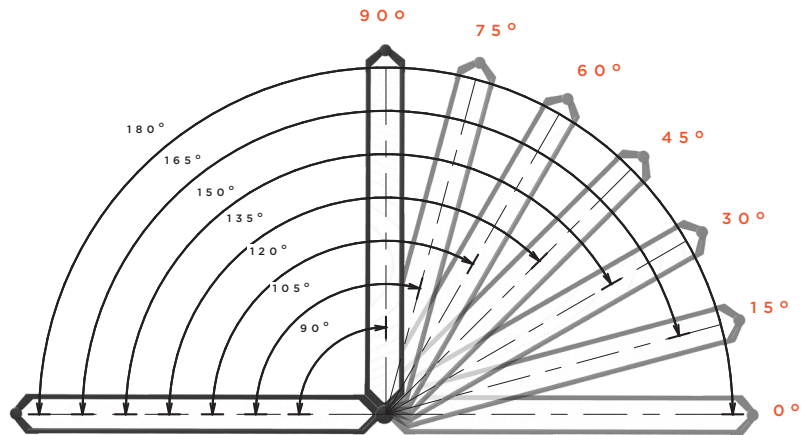

STANDARD TWO ARM FLKs.4 ROTATIONAL HUB PATTERN EXAMPLES



FSL (Straight to L Pattern) is field adjustable in 15° increments from 180° to 90°. FSL Pattern shown is two arm 180°, Hub setting 0°.

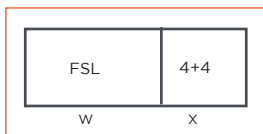

D

Above code gets entered in "D" LENGTH field of ordering guide.



FSL (Straight to L Pattern) is field adjustable in 15° increments from 180° to 90°. Pattern shown is two arm 150°, Hub setting 30°.

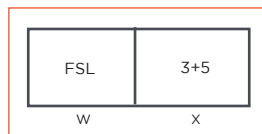

D

Above code gets entered in "D" LENGTH field of ordering guide.



Field adjustable in 15° increments from 180 degree to 90°. Pattern shown is two arm 150°, Hub setting 30°.

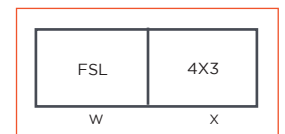

D

Above code gets entered in "D" LENGTH field of ordering guide.



MULTIPLE ARM PATTERNS

Arm lengths 2, 3, 4, 5, 6 ft lengths. Rotational in 15 degree increments adjustments are made in-field with the exception of 90 degree 4 arm pattern.

PATTERN GUIDE

W. FLKs.4 PATTERN	FLKs.4 T-Y (90-135°- Hub Setting 90°- 45°)	X. PATTERN DIMENSIONS
FTY		AxBxC

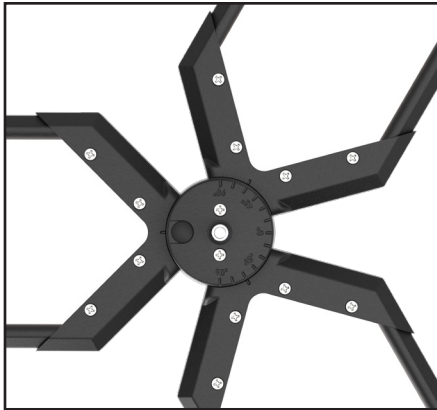

CLOSE UP OF ROTATIONAL HUB

FTY (T or Y Pattern) is field adjustable in 15° increments from 90° to 135°. FTY Pattern corners shown is Y 120°, Hub setting 60°.

90° to 135° ROTATIONAL PATTERN

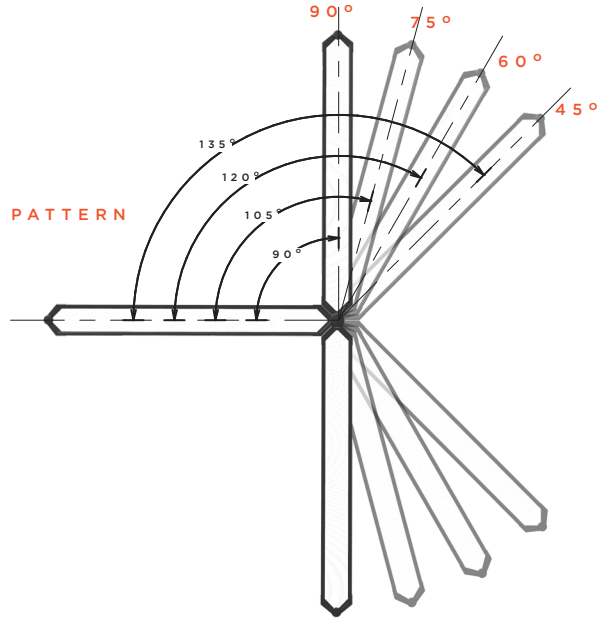

STANDARD LENGTH FLKs.4 HUB PATTERN EXAMPLES

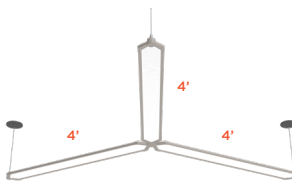

FTY (T or Y) pattern is field adjustable in 15° increments from 0° to 90°. FTY pattern shown is three arm at 120°, Hub setting: Starter position with 60° position, and 60° position to create your 120°; to create your Y pattern.

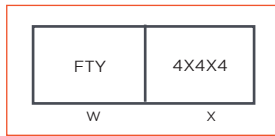

D

Above code gets entered in "D" LENGTH field of ordering guide.

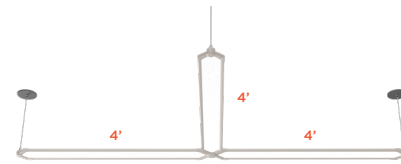

FTY (T or Y) pattern is field adjustable in 15° increments from 0° to 90°. FTY pattern shown is three arm at 90°, and 180°, Hub setting: Starter position with 90° position, and 0° position to create your T pattern.

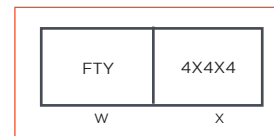

D

Above code gets entered in "D" LENGTH field of ordering guide.

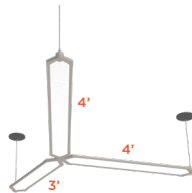

Field adjustable in 15° increments from 0° to 90°. Three arm pattern shown is three arm at 105°, 120°, 135°. Hub setting: 75°, 60°, 45; to create your Y pattern.°.

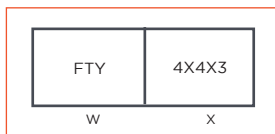

D

Above code gets entered in "D" LENGTH field of ordering guide.

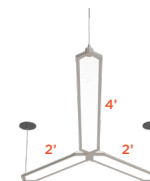

Field adjustable in 15° increments from 0° to 90°. Three arm pattern shown is three arm at 135°, and 135°. Hub setting: Starter position with 90° position, and 0° position; to create your Y pattern.

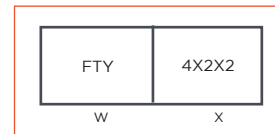

D

Above code gets entered in "D" LENGTH field of ordering guide.



MULTIPLE ARM STANDARD PATTERNS

Arm lengths 2, 3, 4, 5, 6 ft lengths. Rotational in 15 degree increments adjustments are made in-field with the exception of 90 degree 4 arm pattern.

PATTERN GUIDE

W. FLKs.4 PATTERN		X. PATTERN DIMENSIONS
FX	FLKs.4 X	AxBxCxD
FSR	FLKs.4 Square-Rectangle	AxBxCxD
FSR(X)	Multiple FLKs.4 Square-Rectangle	AxBxCxDxExFxG...

(90°- Hub Setting 90°)

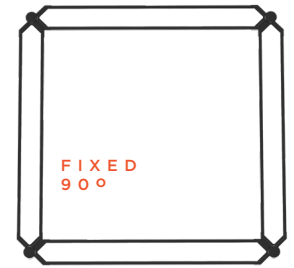
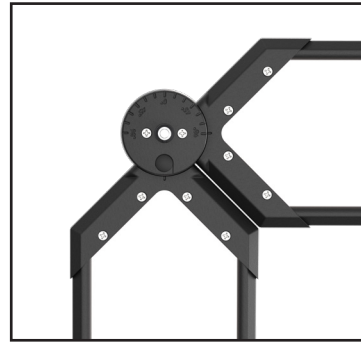
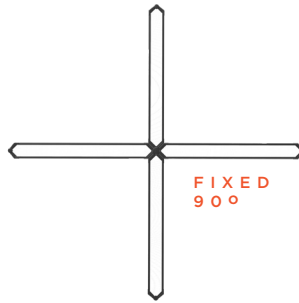
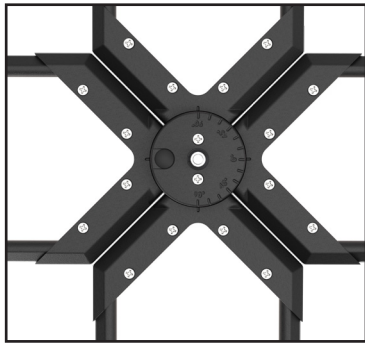

FX (X) pattern is fixed at 90°. FX pattern corners shown with four fixed 90° arms.

FSR (Square or Rectangle) pattern is fixed at 90°. FSR Square pattern corner shown with four fixed 90° arms.

STANDARD LENGTH FLKs.4 HUB PATTERN EXAMPLES

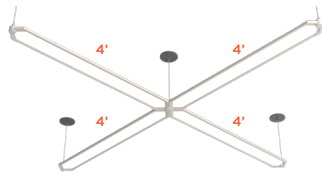

FX (X) pattern is fixed at 90°. FX pattern shown with four fixed 90° arms.



FSR (Square or Rectangle) pattern is fixed at 90°. FSR pattern shown with four fixed 90° arms.

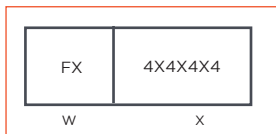

Above code gets entered in "D" LENGTH field of ordering guide.



Above code gets entered in "D" LENGTH field of ordering guide.

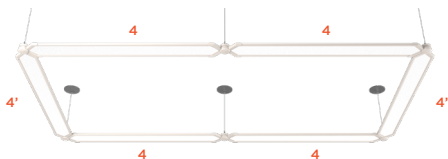

FSR (Square or Rectangle) pattern is fixed at 90° and 180°. FSR pattern shown with four fixed 90° arms, and two 0° arms.

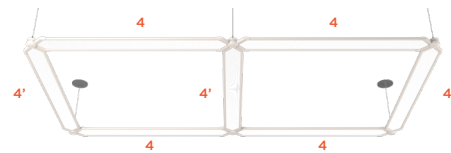

FSR(2) (Two Square or Rectangle) patterns are fixed at 90° and 180°. FSR(2) pattern shown with four fixed 90° arms, and two 0° arms.

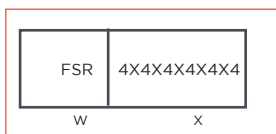

Above code gets entered in "D" LENGTH field of ordering guide.

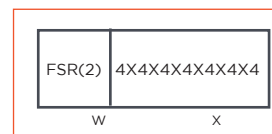

Above code gets entered in "D" LENGTH field of ordering guide.



MULTIPLE ARM PATTERNS

Arm lengths 2, 3, 4, 5, 6 ft lengths. Rotational hub is adjustable in 15° increments. adjustments are made in-field with the exception of 90 degree 4 arm pattern.

PATTERN GUIDE

W. FLKs.4 PATTERN		X. PATTERN DIMENSIONS
FH	FLKs.4 Hex (120° - Hub Setting 60°)	AxBxCxDxExF Total Footage
FG	FLKs.4 Octagon (135° - Hub Setting 45°)	AxBxCxDxExFxGxH Total Footage

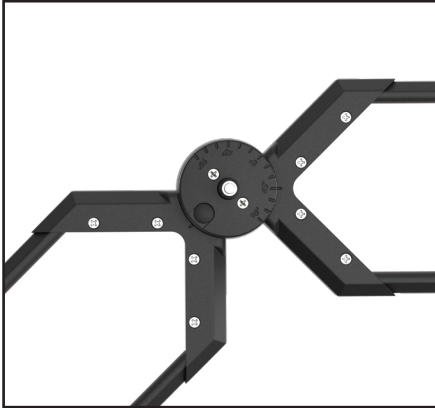

FH (Hex) Pattern shown with six 4' arms 120°, Hub setting 60°.

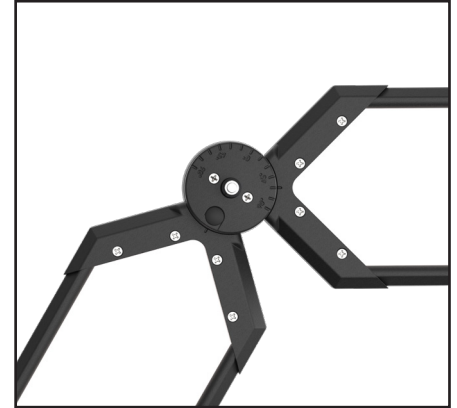

FG (Octagon) Pattern shown with six 4' arms 135°, Hub setting 45°.

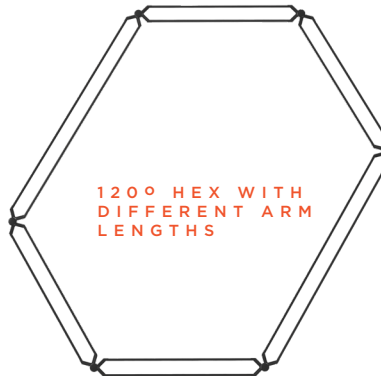
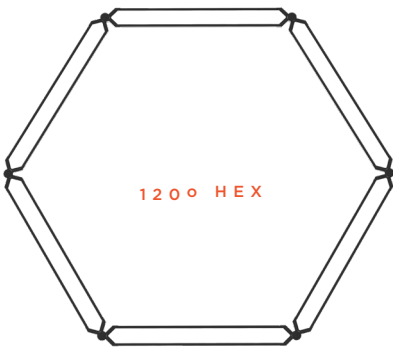

STANDARD LENGTH FLKs.4 HUB PATTERN EXAMPLES

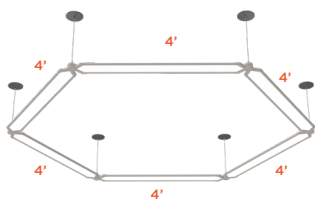

FH (Hex) Pattern shown with six 4' arms 120°, Hub setting 60°.

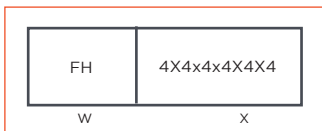

D

Above code gets entered in "D" LENGTH field of ordering guide.

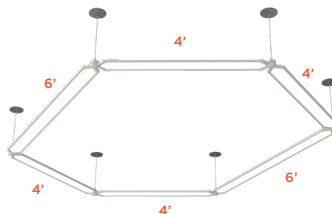

FH (Hex) Pattern shown is four 4' and two 6' arms 120°, Hub setting 60°.

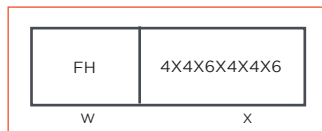

D

Above code gets entered in "D" LENGTH field of ordering guide.

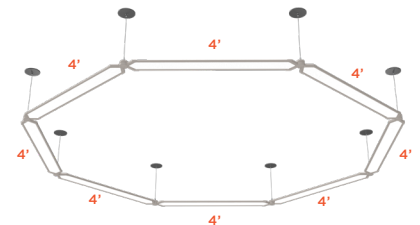

FG (Octagon) Pattern shown with six 4' arms 135°, Hub setting 45°.

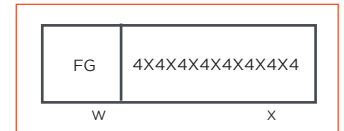

D

Above code gets entered in "D" LENGTH field of ordering guide.



CUSTOM PATTERNS

Include a simple sketch to illustrate your projects scope. Use the key provided to identify length of arms and runs on page 9. (Does not need to be to same scale).



STARTER



JOINER



ENDER

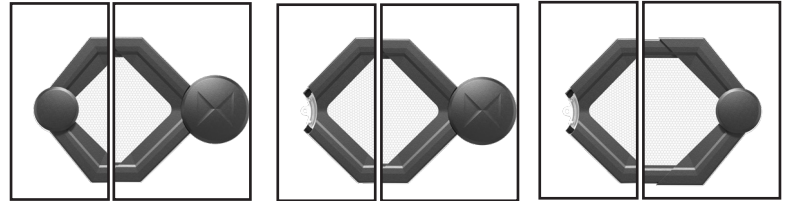

STARTER | HUB

JOINER | HUB

HUB | ENDER

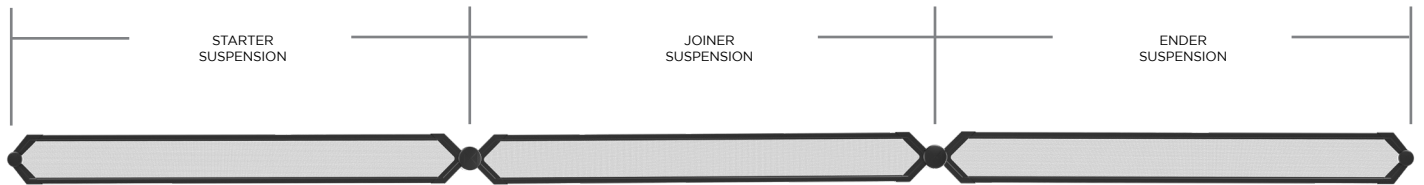

EXAMPLE

NOMINAL JOINER RUN FOR SAME LENGTH UNITS

	Starter Suspension	Joiner Suspension	Ender Suspension	Overall Length
2 Foot Unit	24.00"	25.00"	24.00"	49 Foot Unit
3 Foot Unit	36.00"	37.00"	36.00"	73 Foot Unit
4 Foot Unit	48.00"	49.00"	48.00"	97 Foot Unit
5 Foot Unit	60.00"	61.00"	60.00"	121 Foot Unit
6 Foot Unit	72.00"	73.00"	72.00"	145 Foot Unit

NOTES

Customer to provide a drawing for all patterns with more than (1) hub connector.

CUSTOM LENGTH PATTERN EXAMPLES



PATTERN GUIDE

W. FLKs.4 PATTERN

FCC

Custom Pattern
- Sketch or Drawing Always Required
Multiple Links

X. PATTERN DIMENSIONS

Run Lengths (Quote #, A, B, C...)
Number created by LUX

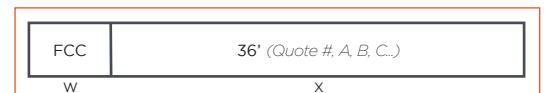

D



SKETCH CUSTOM PATTERN & DIMENSIONS

Include a simple sketch to illustrate your projects scope.

Use the key provided to identify length of arms, runs and connectors.

(Does not need to be to same scale).

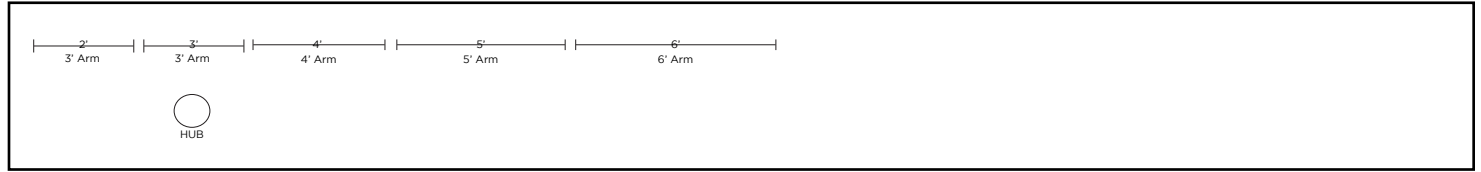

YOUR SKETCH



DRIVER HOUSING MOUNTING OPTIONS

REMOTE HOUSING

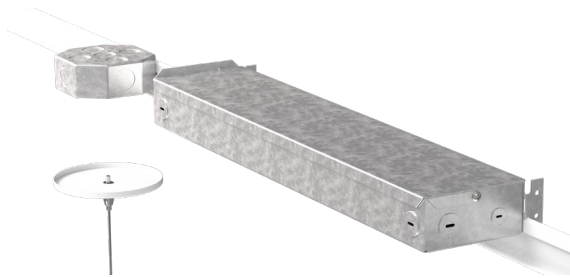

Grid-mountable driver housing with integrated T-Wing mounts.

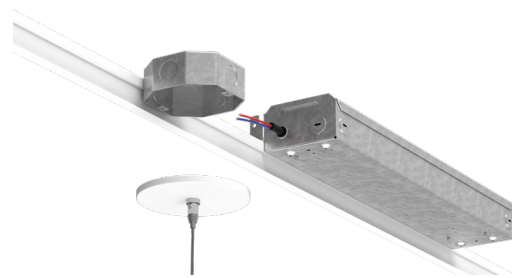

Remote-mounted driver housing with integrated mounting features, including power feed, canopy, and suspension system. Suitable for exposed conduit, or recessed junction boxes.