

Project		Catalog #		Type	
Prepared by		Notes		Date	

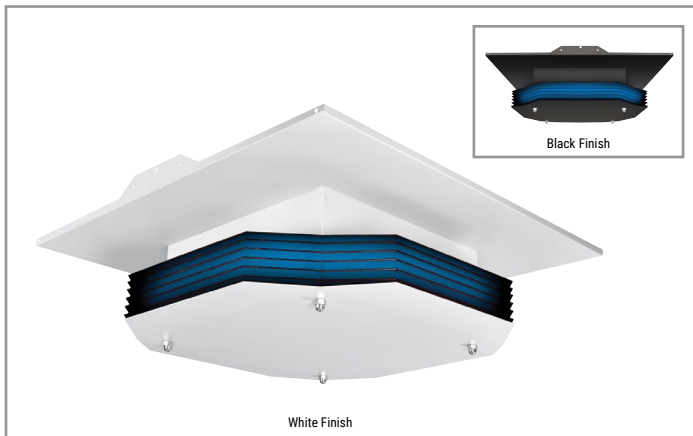

Fail-Safe

GAC Germicidal Air Ceiling Mount

Germicidal Air Disinfection
2x2 Suspended

Typical Applications

Retail • Commercial • Education • Hospitality

Interactive Menu

- Order Information [page 2](#)
- Germicidal Energy Distributions [page 3](#)
- GUV Education [page 4](#)

Product Certification



Product Features



Top Product Features

- Able to be used in occupied spaces
- Designed to use the latest in Germicidal UV source technology
- Fits in a 2x2 grid opening
- Symmetrical Coverage Area
- Horizontal distribution keeps GUV in upper air
- UL 1598 Listed
- Options to meet Trade Agreements Act requirements

Pure protection against bacteria and viruses using the power of light



Trusted

35 years experience in UV-C disinfection and strong application expertise.



Effective

Proven effectiveness against bacteria, mold, mildew, and viruses.



Continuous

Can be used in occupied spaces.



Versatile

Can be used in numerous applications.

Order Information

SAMPLE ORDER NUMBER: **22GAC-4GUV9W-UNV-R1-W**

Domestic Preferences	Fixture	No. of Sources	Source Type	Wattage	Voltage	Driver	Finish	Accessories
Domestic Preferences ⁽¹⁾	Fixture	No. of Sources	Source Type	Wattage	Voltage	Driver	Finish	Accessories ⁽²⁾
[Blank]=Standard TAA=Trade Agreements Act	22GAC=Germicidal Air Ceiling Mount	4=4 Sources	GUV=Germicidal UV Emitter	9W	UNV=Universal Voltage 120-277V	R1=Single Rapid Start Driver	W=White B=Black	DF-22W-U=2x2 Drywall Kit
Notes <small>(1) Only product configurations with this designated prefix are built to be compliant with the Trade Agreements Act of 1979 (TAA). Please refer to DOMESTIC PREFERENCES website for more information. Components shipped separately may be separately analyzed under domestic preference requirements.</small>								Notes <small>(2) Accessories sold separately will be separately analyzed under domestic preference requirements. Consult factory for further information.</small>

Replacement Parts

Replacement Parts
GUV-LAMP-9W-U=9W TUV Replacement Source BAL-GAC-4/9W-R-PK=Replacement 4/9W-emitter Rapid Start Driver GAC-GRID-CLIP-PK=Replacement Grid Clips

Product Specifications

Germicidal UV

- Germicidal UV source technology using quartz enclosure and long-life igniter to maximize the run time and ensure optimal germicidal efficiency
- Utilizes GUV sources operating at 254nm wavelength
- GUV is a proven disinfection technology effective on pathogens including mold, fungi, bacteria, and viruses
- GUV power is delivered up to 9000 hours while maintaining at least 80% of the initial GUV energy
- Rapid Start electronics extend the life to up to 25,000 start-up cycles

Construction

- Die-formed steel housing
- Emitter included with fixture

Product Warranty

- 5 year product warranty for fixture and ballast. Lamps are not included.

Finish

- Polyester powdercoat finish on housing and endcaps
- Matte white and low-gloss black standard finishes available
- Louvers standard with black finish

Optics

- Reflector made of specular aluminum specifically tuned to maximize the germicidal energy output
- Louvers limit reflectivity of germicidal energy outside of the horizontal plane to comply with IEC 62471 Photobiological Risk Group 0 classification
- Distribution focuses disinfection energy where it is needed, maximizing efficiency

Mounting

- Fits in 2x2 Ceiling Grid
- Minimum ceiling height of 9ft
- Minimum recommended spacing is 12ft on center and 6ft from nearest wall
- Professional layouts can be completed by Cooper Lighting Solutions upon request

Compliance

- This GUV product is designed to comply with Risk Group 0
- UL 1598 listed GUV fixture
- UL1598 annex L states it is the responsibility of the installer to ensure that persons will not be exposed to excessive UV or optical radiation during equipment operation. This will require the installer to conduct an assessment of irradiance levels in the surrounding occupied spaces prior to occupancy.
- Product complies with FCC part 18 limits
- This device has not been evaluated by the FDA, and is not approved for use in medical applications
- EPA Facility # 095792-CAN-1

Warnings and Safety

- GUV Sources emit high-power UV radiation that can cause severe injury to skin and eyes. Avoid eye and skin exposure to unshielded products.
- GUV may cause degradation and fading of paints, fabrics and other materials
- Plants and/or materials that are exposed to UV-C and/or ozone for a long time may become damaged and/or discolored

Shipping and Electrical Data

Catalog No.	Wattage	Wt.
22GAC-4GUV9W-UNV-R1-W	36.2	30 lbs
22GAC-4GUV9W-UNV-R1-B	36.2	30 lbs

Note: Sources are sold with the fixture but ship uninstalled in packaging.

Germicidal Energy Distribution

Spacing criteria is based on optical only. For GUV layouts, this will depend on dosing needed and the time desired to disinfect the desired area.

[View IES files](#)

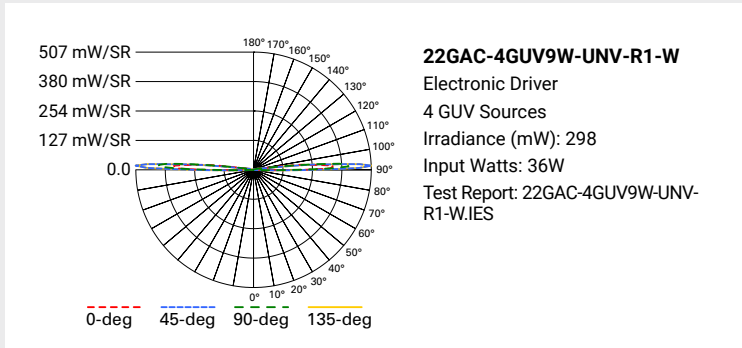

Dimensional and Mounting Details

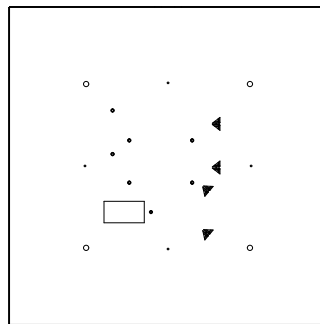
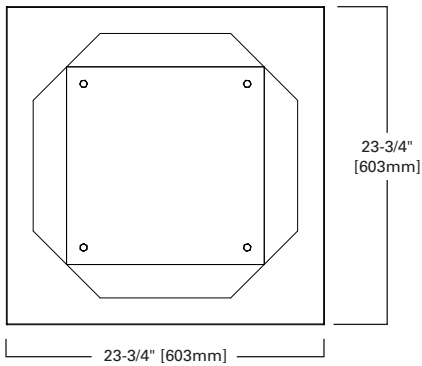
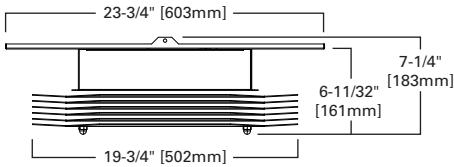

GUV Education

- GUV (germicidal ultraviolet) is a proven and effective disinfection technology.
- GUV refers to short-wavelength ultraviolet "light" outside of the visible spectrum that is proven to kill bacteria and inactivate viruses...FAST! These short wavelengths in the photobiological UV spectral band known as "UV-C" are centered at 254nm, which is the optimal source wavelength for eliminating pathogens.
- GUV is an excellent air disinfectant due to its quick germicidal efficacy.
- Germicidal effectiveness is determined by the "fluence" or germicidal irradiance dose in the air.
- GUV can pose a safety and health hazard to the eyes and skin if the product is improperly used or installed.
- Follow recommended practices for utilization and control of GUV fixtures.

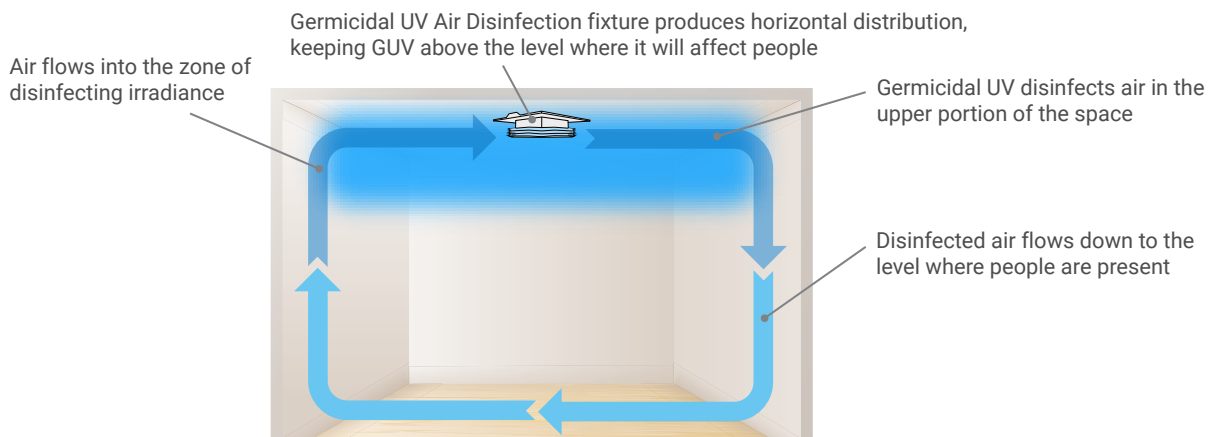
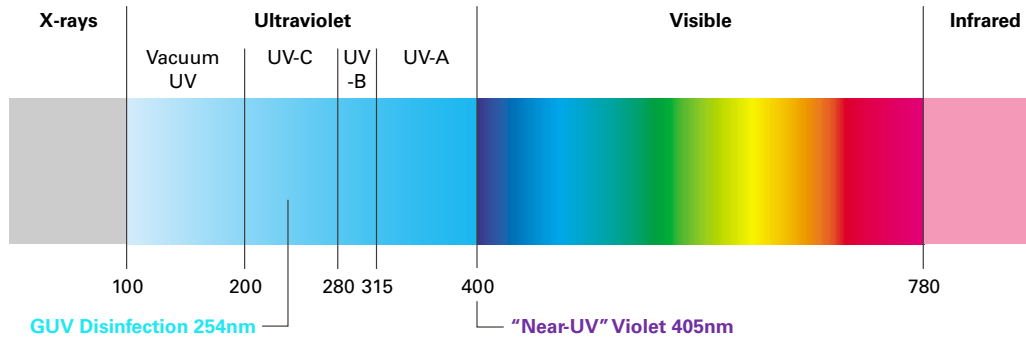

For more information on Fail-Safe GUV Disinfecting Solutions, please visit www.cooperlighting.com/GUV