

Day-Brite

CFI

by ignify

Industrial

FBX high bay

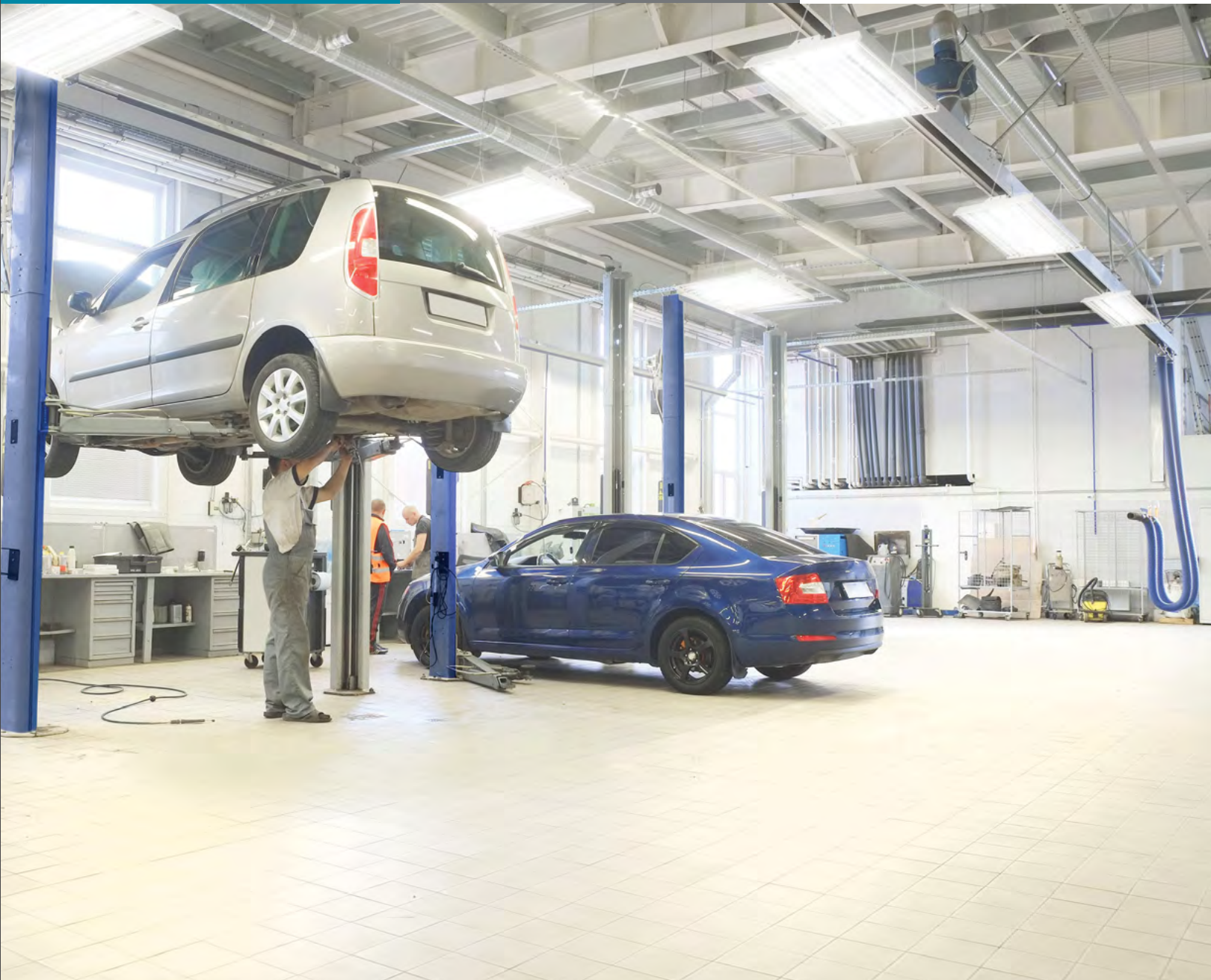

**Enjoy flexibility and savings
along with quality illumination**

Enjoy flexibility and savings along with quality illumination

The Day-Brite / CFI FBX LED high bay is a compact and economical luminaire utilizing the latest in LED technology.

With several lumen packages and optical distribution patterns available, the FBX offers exceptional lighting in mid to high ceiling applications. Save energy without straining your project budget or sacrificing your light output.



2' FBX

The 2' FBX is available in both extruded and sheet metal construction (sheet metal shown in photos). It is also available in both narrow (14.75") and wide (24") housings to allow a variety of lumen packages.

FBX08L
FBX12L



FBX16L
FBX20L
FBX24L





4' FBX

The extruded construction of the 4' FBX provides better heat dissipation for higher ambient applications. Available in wide housing only, this luminaire is suitable for high lumen applications.

FBX36L
FBX45L

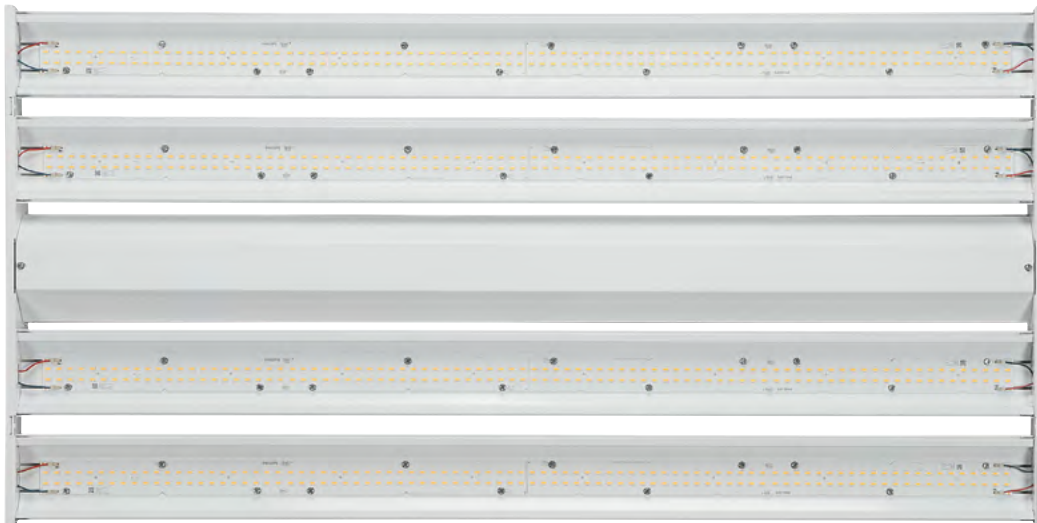

Gain versatility without sacrificing continuity

For maximum versatility, the FBX features 7 lumen packages with efficacies up to 146 LPW, along with multiple optical configurations and lens options.

Its modular design provides the flexibility of different outputs and multiple distributions, all from the same basic luminaire construction, allowing you to choose just the right solution for each space within your application, while maintaining fixture continuity.



FBX with Clear Acrylic Lens (LCA) option



FBX general distribution (no optics)



FBX with Frosted Acrylic Lens (LFA) option



FBX with optics (Narrow, Medium, Wide, or Aisle)

Choose your optical distribution

Each optic is designed for a specific purpose.

The general distribution allows a wash of light in any application. The aisle beam has an asymmetric distribution for aisle or rack areas. The narrow beam allows focused light in higher ceiling areas. The medium beam is tailored for mid mounting heights. The wide beam is perfect for low bay areas or locations with wider fixture spacing.

General

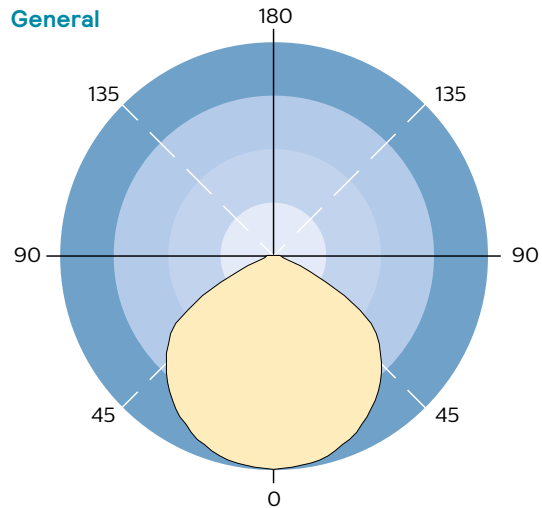

Aisle

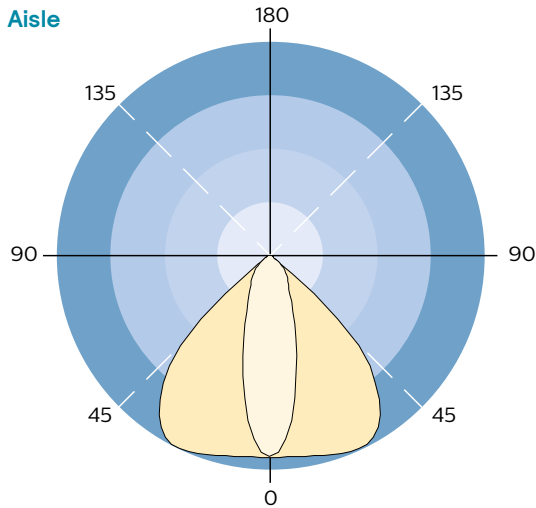

Narrow

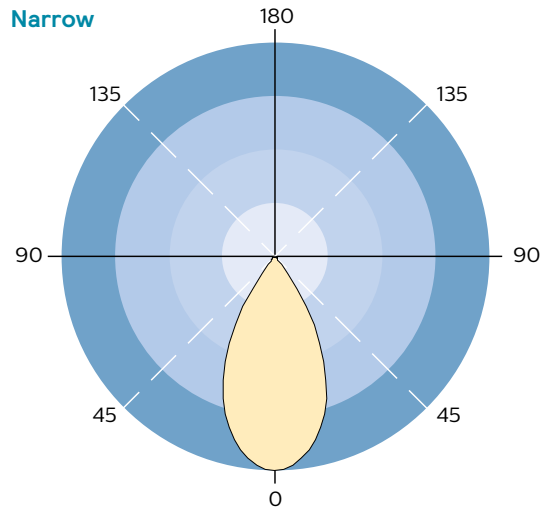

Medium

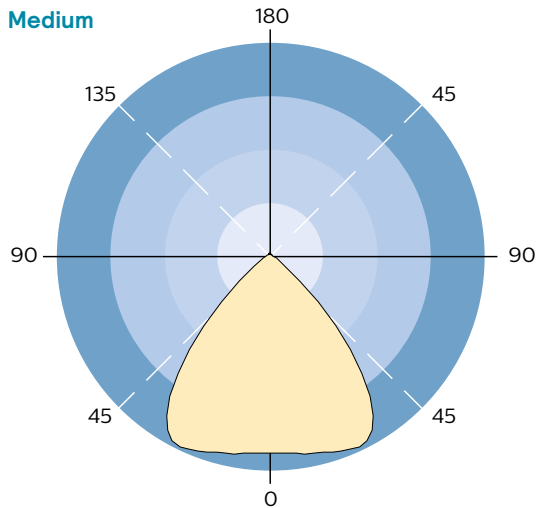

Wide

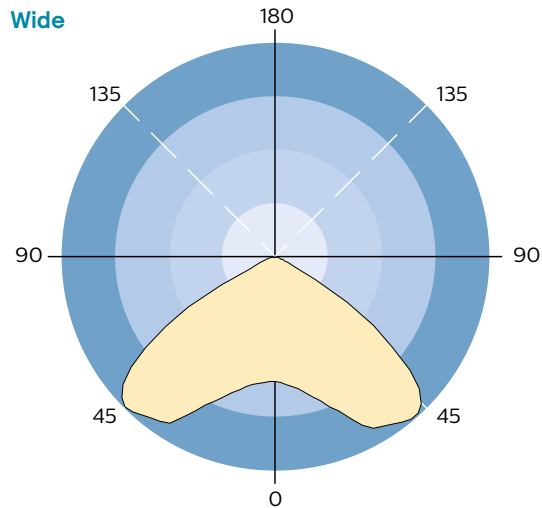

Explore your options

This comprehensive LED high bay family is ideal for illuminating warehouses, industrial areas, big box retail settings, along with many other applications.

A variety of mounting options are available, including chain, pendant, and cable. Dimming drivers are standard, and motion detectors are optional to give complete control over energy savings. Wire guards are also available.

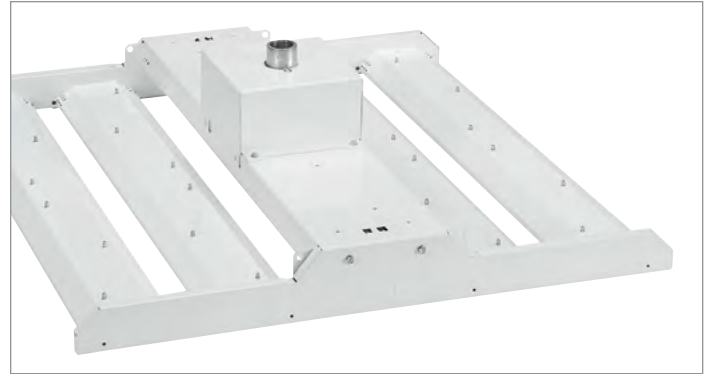

Pendant Hanger

FBX-PENHGR Pendant hanger
(not available for 36,000 or 45,000 lumen versions)



Chain Kit

FBX CHAIN KIT 54" Chains and V brackets

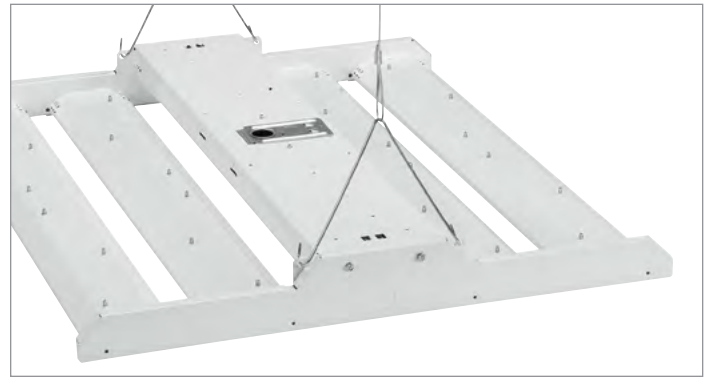

Cable Kit

FBX-GRIP5 5' Cables and V brackets
FBX-GRIP10 10' Cables and V brackets



Wire Guards

WG-FBX-2N Wire guard for 8,000 and 12,000 lumen versions
WG-FBX-2W Wire guard for 16,000, 20,000, and 24,000 lumen versions
WG-FBX-4 Wire guard for 36,000 and 45,000 lumen versions



Emergency Option

EMLED Emergency battery (40°C max)
EMLEDC Emergency battery cold temp (40°C max)

Select your luminaire

High ambient

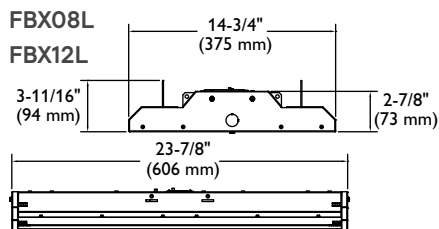
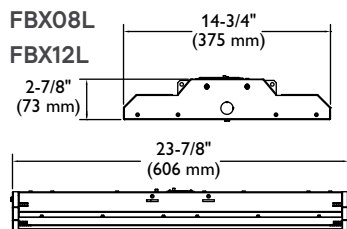

FBX16L

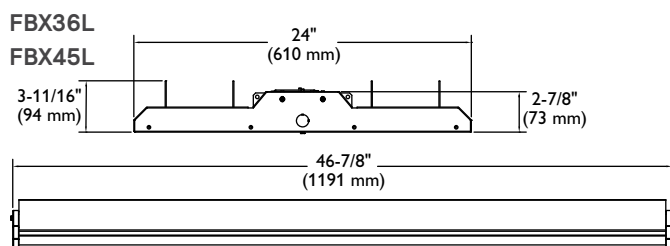
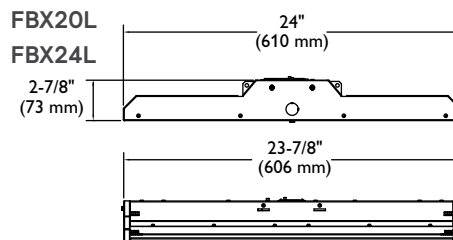

High ambient

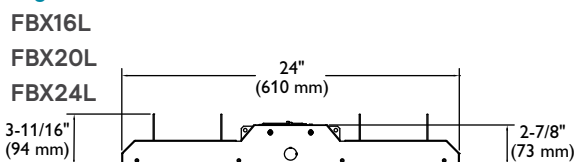

Ordering guide

Example: FBX24LL40-UNV

Family	Lumen Package	Source	Color Temperature	Voltage	Distribution	Options
FBX		L	-	-	-	
FBX	08L 8,000 nominal delivered lumens 12L 12,000 nominal delivered lumens 16L 16,000 nominal delivered lumens 20L 20,000 nominal delivered lumens 24L 24,000 nominal delivered lumens 36L 36,000 nominal delivered lumens 45L 45,000 nominal delivered lumens	L LED	35 3500K (CRI 80) 40 4000K (CRI 80) 50 5000K (CRI 80)	UNV Universal voltage 120-277V 120 120V 208 208V 240 240V 277 277V 347 347V 480 480V	Blank General Distribution N Narrow M Medium W Wide A Aisle	WP6³ Wired 6' 16/3 Cord & NEMA Twist lock plug WC6 Wired 6' 16/3 Cord WP6D³ Wired 6' 16/3 Cord & NEMA Twist lock plug w/disconnect plug for dimming control WC6D Wired 6' 16/3 Cord for line voltage and wired 6' cord for dimming control MD360^{2,3} 360° Motion detector (ON/OFF) MD360D^{2,3} 360° Motion detector (ON/DIM) EMLED Emergency battery (0°C - 40°C) EMLEDC² Emergency battery cold temp (-20°C - 40°C) 55² High ambient (55°C) LCA Clear acrylic lens LFA Frosted acrylic lens LCR Clear ribbed lens LFR Frosted ribbed lens LCP Clear polycarbonate lens SP1 Optional 10KV surge protector GLR¹ Fusing, fast blow SWI⁴ SpaceWise wireless technology for integrated occupancy (50°C max.) ⁴

Accessories (order separately)

- FBX-PENHGR** Pendant hanger (not available for 36,000 or 45,000 lm versions)
- FBX CHAIN KIT** 54" chains & V brackets
- FBX-GRIP5** 5' cables & V brackets
- FBX-GRIP10** 10' cables & V brackets
- WG-FBX-2N** Wire guard for 8,000 and 12,000 lumen versions
- WG-FBX-2W** Wire guard for 16,000, 20,000, and 24,000 lumen versions
- WG-FBX-4** Wire guard for 36,000 and 45,000 lumen versions

See spec sheet for more accessories.

General Notes

All options factory installed. All accessories are field installed. DLC Listing for most variations. Please check the DLC Qualified Products List to confirm (www.designlights.org/QPL).

Many luminaire components, such as reflectors, refractors, lenses, sockets, lampholders, and LEDs are made from various types of plastics which can be adversely affected by airborne contaminants. If sulfur based chemicals, petroleum based products, cleaning solutions, or other contaminants are expected in the intended area of use, consult factory for compatibility.

Wiring Notes

Standard cords have 3 wires. Consult factory for other cord options.

Footnotes

1. GLR fusing not available for 347V or 480V
2. Not available with SpaceWise (SWI) option
3. Must specify line voltage.
4. Must order SWZ-REMOTE SpaceWise handheld remote with each system order.



