

Day-Brite CFI

by 

Recessed

Coffaire LED 2x2

2100, 2500, or 2800 lumens



Project: _____
 Location: _____
 Cat.No: _____
 Type: _____
 Lamps: _____ Qty: _____
 Notes: _____

The Day-Brite / CFI Coffaire LED recessed combines a perforated mesh lamp shield with a white acrylic overlay in an indirect cover to create an aesthetically pleasing direct/indirect luminaire.

Ordering guide

Example: CFS22GPG21L40UDZT

Family	Air Function	Fixture Size	Ceiling Type	Diffuser	Lumen Package	Color Temp.	Voltage	Driver Type	Options
<input type="checkbox"/> CF	<input type="checkbox"/> S	<input type="checkbox"/> 22	<input type="checkbox"/> G					—	
CF Coffaire direct/indirect recessed luminaire	S Static	22 2'x2'	G Fits both standard and slot grid Consult factory for other ceiling systems.	PG Perforated lamp shield with dust shield PF Perforated lamp shield with acrylic overlay PD Perforated lamp shield with insect shield	21L 2100 lumens 25L 2500 lumens 28L 2800 lumens 4000K represented (Approximate delivered values. Consult IES file)	35 3500K 40 4000K 50 5000K Consult representative for other color temperature options. (Approximate values. Consult IES file.)	U Universal voltage 120-277V 3 347V	DZT 0-10V dimming F1 3/8" flex, 3 wire 18 gauge 6' F2 3/8" flex, 4 wire 18 gauge 6' F1/D 3/8" twin flex, 3 wire 18 gauge 6' for dimmable luminaires SZT Step dimming to 1% F2/SW 3/8" single flex, 5 wire 18 gauge 6' for dimmable luminaires GLR Fusing, fast blow EMLED Integral emergency battery pack CHIC Chicago Plenum rated	

Accessories (order separately)

- FMA22 – 2'x2' "F" mounting frame for NEMA "F" installations

CFS Coffaire LED recessed 2x2

2100, 2500, or 2800 lumens

Features

- Direct/indirect lamp shield appearance with soft contoured interior.
- Perforated mesh lamp shield with white acrylic overlay.
- Separate impact resistant acrylic top refractors enclose LED compartment, minimizing penetration of dust and insects.
- Contoured body and ends.
- Only 5" deep.
- Field replaceable LED array and drivers accessible from below.
- Integrated thermal management system conducts heat away from LEDs and transfers it to the surrounding environment.
- Intelligent driver technology, our LED platform, is a factory calibrated system providing the customer multiple lumen outputs to balance energy savings with lighting application needs.
- High efficiency LEDs have 50,000 hour rated life at L70.
- Predicted L70 lifetime is based on LED manufacturer's supplied LM-80 data and in-situ laboratory testing.
- Tension screws secure ends to body.

- Perforated lamp shield hinges from either side.
- Same fixture fits both G and Slot T ceiling types.
- Fits flush to face of slot grid (T) ceiling types.
- Suitable for continuous row mounting.
- Built-in earthquake clips.
- Construction to meet Chicago Plenum available.
- Five-year warranty on luminaire, LED boards and driver.

Specifications

- **Materials:** Chassis parts – die-formed code gauge steel. Lamp Shield – steel perforated mesh lamp shield with white acrylic overlay. Refractors – clear impact resistant acrylic
- **Finish:** Chassis exterior – white baked polyester enamel. Cavity – baked polyester enamel, rust preventative undercoating,
- **Electrical:** LED boards and drivers are RoHS (Restriction of Hazardous Substances) compliant.
- **Labels:** cULus listed for damp locations.

Mounting methods

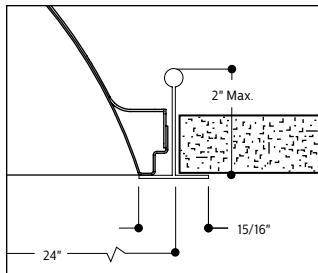

exposed t-grid ceiling*

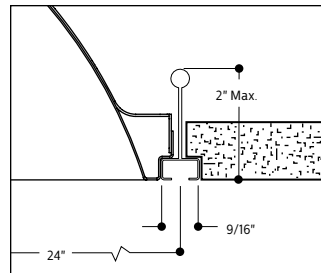

exposed slot t-grid ceiling*

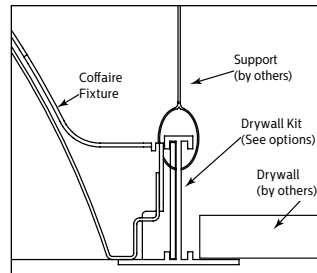

Drywall Kit for use with "G" type fixture. Catalog number: **FMA22**

* For flush mounting when using 9/16" Exposed T-Grid ceiling system consult factory

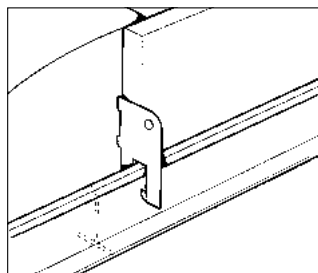

built-in earthquake clips

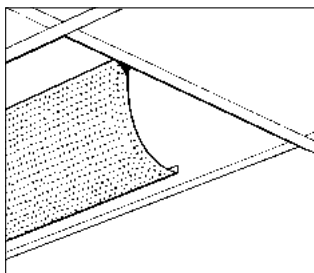

lamp shield hinges either side

Dimensions

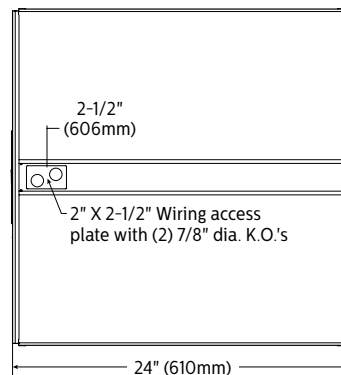
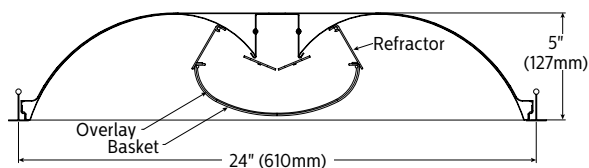

CFS Coffaire LED recessed 2x2

2100, 2500, or 2800 lumens

Additional ordering information – 4000K CCT

Catalog Number	Delivered Lumens	Input Watts	Lumens per Watt	Average initial 8'X8' footcandles	8'X8' Watts per sq. foot	Average initial 8'X10' footcandles	8'X10' Watts per sq. foot
CFS22GPG21L40ULAG	2055	31.3	65.7	32	0.49	26	0.39
CFS22GPG25L40ULAG	2543	40.6	62.6	40	0.63	32	0.51
CFS22GPG28L40ULAG	2820	46.9	60.3	44	0.73	35	0.59

Photometry – 4000K CCT

Report number:	G2012327	
Catalog number:	CFS22GPG28L40ULAG	
Delivered lumens:	2820	
Color ² :	4000K	
Input watts:	46.8	
Efficacy:	60.3 lm/w	
CRI:	83.8	
Lamp:	LED	
Luminaire:	Coffaire recessed LED 2' x 2' fixture with perforated basket.	
CIE Type:	Direct	
Plane:	0-Deg.	90-Deg.
Spacing criteria:	1.2	1.3
Plane:	0-Deg.	90-Deg.
Luminous length:	23.040	23.040

Candela distribution

Vertical Angle	Horizontal Angle			Zonal Lumens
	0°	45°	90°	
0	1020	1020	1020	96
15	958	972	987	274
5	1012	1014	1018	96
25	865	895	929	413
35	740	791	846	496
45	594	666	738	513
55	428	522	602	463
65	258	361	413	344
75	128	172	201	179
85	28	35	36	40
90	3	3	3	

¹ Tested using absolute photometry as specified in LM79: IESNA Approved Method for the Electrical and Photometric Measurements of Solid-State Lighting Products.

² Correlated Color Temperature within specs as defined in ANSI_NEMA_ANSI C78.377-2008: Specifications for the Chromaticity of Solid State Lighting Products.

Coefficients of utilization

Ceiling	80%			50%			30%			
	70	50	30	50	30	10	50	30	10	
RC	Zonal Cavity Method									
RW	Effective Floor Reflectance = 20%									
Room Cavity Ratio	1	109	104	100	98	95	92	94	91	89
2	99	91	84	86	80	76	82	78	74	
3	90	80	72	75	69	64	73	67	62	
4	83	71	62	67	60	54	65	58	53	
5	76	63	54	60	53	47	58	51	46	
6	70	57	48	54	47	41	52	46	41	
7	65	52	43	49	42	36	48	41	36	
8	61	47	39	45	38	32	44	37	32	
9	57	43	35	41	34	29	40	34	29	
10	53	40	32	38	31	27	37	31	26	

Avg. Luminance (cd/m²)

Vertical Angle	Horizontal Angle		
	0°	45°	90°
45	2452.	2749.	3046.
55	2178.	2656.	3063.
65	1782.	2493.	2852.
75	1444.	1940.	2267.
85	938.	1172.	1206.

Zonal lumen summary*

Zone	Lumens	% Lamp	% Fixt.
0-30	784	27.8	27.8
0-40	1280	45.4	45.4
0-60	2256	80.0	80.0
0-90	2820	100.0	100.0
90-180	0	0	0
0-180	2820	100.0	100.0

*Total Efficiency

