

Installation Instruction Supplement – Luminaire with Distributed Low-Voltage Power System and Optional Integrated Sensor

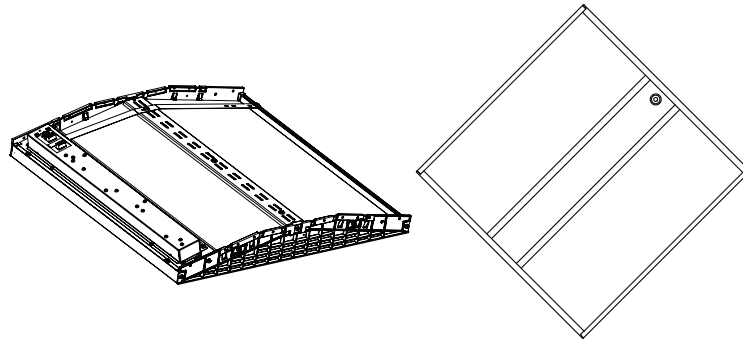

System Overview - Distributed Low Voltage Power System (DLVP)

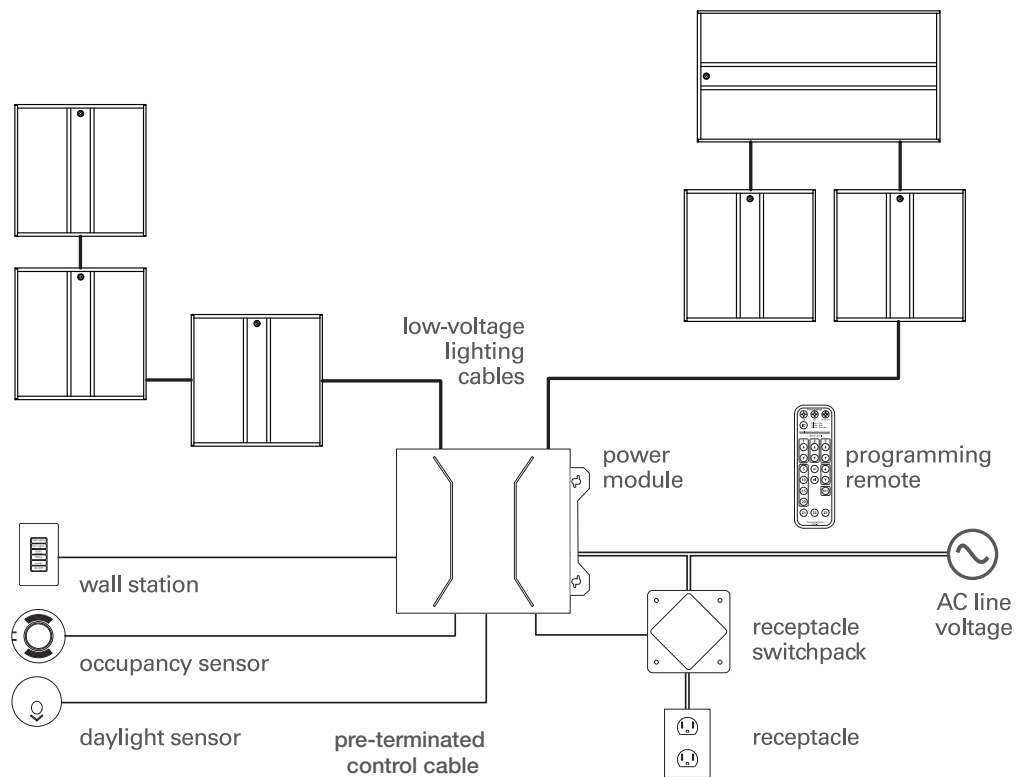

Note: When optional integrated sensors are used on any one zone, all luminaires on a power module must have integrated sensors. Optional integrated sensor shown.

Note: Minimum system requires at least one luminaire, at least one power module and at least one low-voltage lighting cable.

Refer to Distributed Low Voltage Power System documents for full details and operation

Luminaire with Distributed Low-Voltage Power System and Optional Integrated Sensor

IMPORTANT: Read carefully before installing fixture.
Retain for future reference.

SAFETY INSTRUCTIONS

IMPORTANT SAFEGUARDS

READ AND FOLLOW ALL SAFETY INSTRUCTIONS

- Class 1 component installation should be performed by a qualified electrician.
- Installation shall be in accordance with all applicable local and NEC codes.
- Turn the power off at circuit breaker before wiring electrical components.
- Designed for indoor installation and use only. Dry location rated.
- All new wiring must be fully verified before applying power.

Servicing of equipment should be performed by qualified service personnel.

WARNING

Risk of fire, electrical shock, cuts and or other casualty hazards. This product must be installed in accordance with the applicable installation code by a qualified electrician or a person familiar with the construction and operation of the product and the hazards involved. Cooper Lighting Solutions assumes no responsibility for claims brought about by improper or careless installation or handling of this product.

ATTENTION

Receiving Department: Note actual fixture description of any shortage or noticeable damage on delivery receipt. File claim for common carrier (LTL) directly with carrier. Claims for concealed damage must be filed within 15 days of delivery. All damaged material, complete with original packing must be retained.

CAUTION

Edges may cut. Handle with care.

CAUTION

Risk of burn. Disconnect power and allow fixture to cool before changing or handling fixture.

WARNING

Risk of fire and electric shock. If not qualified, consult an electrician.

INSTALLATION

Fixture Installation/Wiring

1. Follow all installation instructions for the luminaire.
2. The optional integrated sensor is factory wired to the luminaire, and does not require additional field wiring.
3. Remove all luminaire and sensor protective covers prior to using the integrated sensor system.
4. Install all luminaires in the same area with the integrated sensor in the same orientation, or as indicated on the lighting plan.
5. Refer to information later in this guide, and the DLVP system instruction manual.

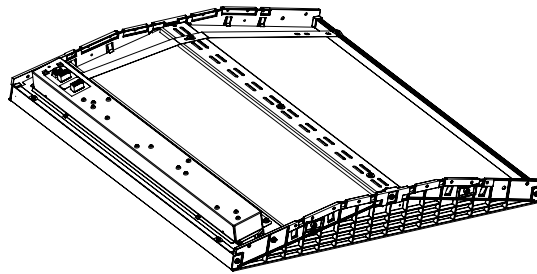
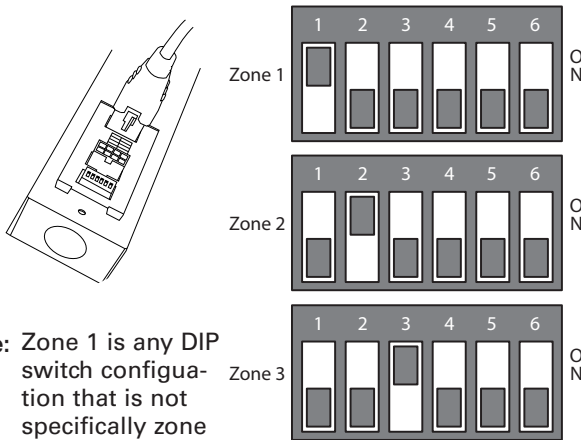

Figure 1.

Fixture Zone Assignment

After connection, assign zones to each luminaire, either by using the DIP switches on the luminaire, or using the programming remote LVHH-01 (optional) when the SV integrated sensor is installed.



Note: Zone 1 is any DIP switch configuration that is not specifically zone 2 or zone 3.

Note: Never set all DIP switches to ON.

Start Up Behavior

Item No.	Action
1	Turn power ON to the fixture.
2	Fixture will illuminate to full output.
3	If installed, the optional integrated sensor is now available for use with the optional remote control.
4	If installed, the optional integrated sensor will turn the fixture off after 20 minutes.*

*Item 4: A setting on the Power Module must be changed, or optional wall stations must be connected, or an optional remote used to turn the lights on.

To manage the operation of the luminaire when the integrated sensor system is installed, use the settings below. Refer to the DLVP system manual for additional instructions.

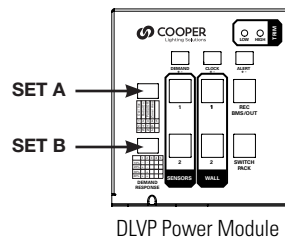

Set A

Position	Operation
V	Vacancy
O	Occupancy

Optional Integrated Sensor

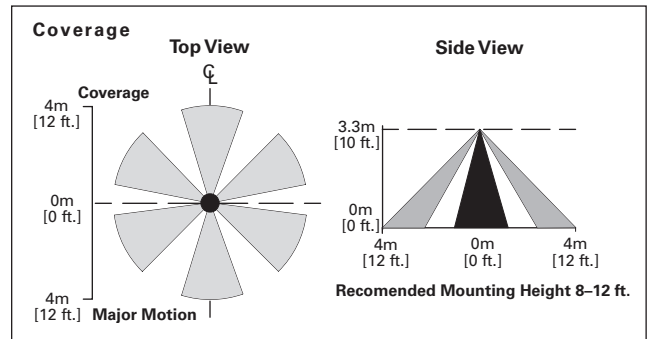

An optional integrated sensor system is available for maximum energy savings. A sensor is installed in each luminaire, turning the fixture on and off based on occupancy, and adjusting the fixture light output based on the amount of light around it (closed loop). The sensor system also acts as a control and programming input point to the system. See the DLVP system instruction sheet for more information.

Note: Remote control optional. Remote required to make configuration change.

1. The coverage pattern shown above depicts the area below the luminaire where the integrated sensor system can detect occupancy.
2. Spacing between fixtures should not exceed the coverage pattern of the sensor.
3. Mounting height should not exceed 12 feet.
4. Exceeding these spacing/height guidelines will result in reduced integrated sensor performance.

Programming when using Optional Integrated Sensor and Remote

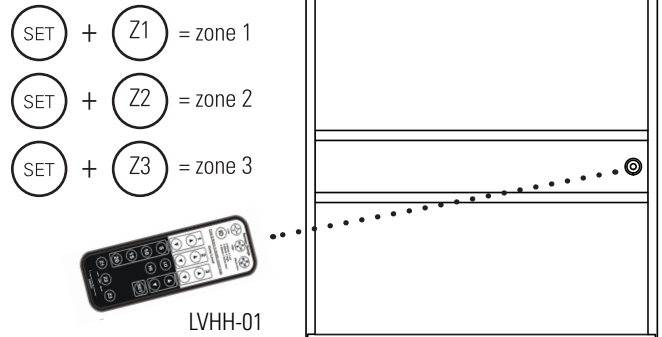

Optional Integrated Sensor Factory Defaults

Occupancy Detection Mode	Manual On (vacancy), active
Default Occupancy Time Out	20 minutes
Occupancy Sensitivity	High
Fade Up/Down Time	Minimum to Maximum in 9 seconds
Daylight Harvesting Level	Off

Note: Above settings are configurable. See DLVP system manual for additional instructions.



Cooper Lighting Solutions

18001 East Colfax Avenue

Aurora, CO 80011

P: 303-393-1522

www.cooperlighting.com

For service or technical assistance:

1-800-553-3879

© 2020 Cooper Lighting Solutions

All Rights Reserved

Printed in USA

Publication No. IB519033EN

October 23, 2016

Cooper Lighting Solutions is a registered trademark. All trademarks are property of their respective owners.

Product availability, specifications, and compliances are subject to change without notice.