

Project		Catalog #		Type	
Prepared by		Notes		Date	

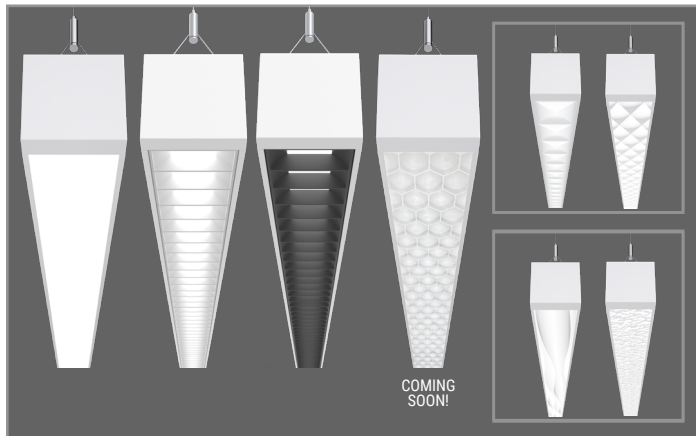

# Corelite

## Continua™ SQ4

LED  
Suspended  
Direct, Direct/Indirect, Indirect

### Typical Applications

• Office • Education • Healthcare • Hospitality • Retail

### Interactive Menu

- Order Information page 2
- Photometric Data page 5
- Energy and Performance Data page 3
- Control Systems page 10
- Product Warranty

### Product Certification



### Product Features



### Top Product Features

- Compact square design with integral electrical components and circuiting options
- Seamless illumination with single-piece luminous roll lens
- Black and white glare reducing louvered baffle options
- Precision indirect batwing optic for maximizing ceiling uniformity and on-center spacing
- Wide range of direct/indirect distributions plus independent up/down circuiting
- Up to 147 lumens per watt Direct-Indirect, 164 lumens per watt Indirect
- Options to meet Buy American Act requirements

### Dimensions

#### Cross Section Views

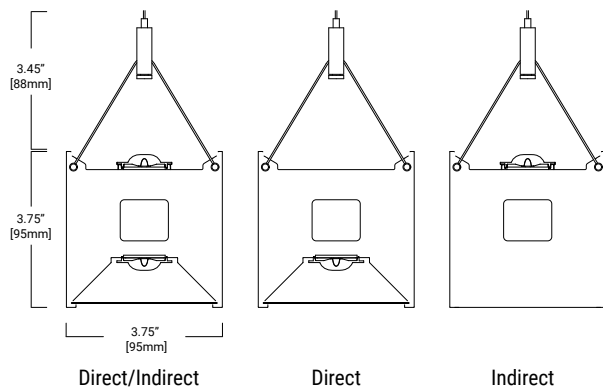

#### Top Views

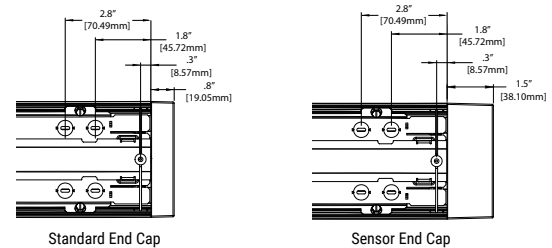

#### Bottom Views

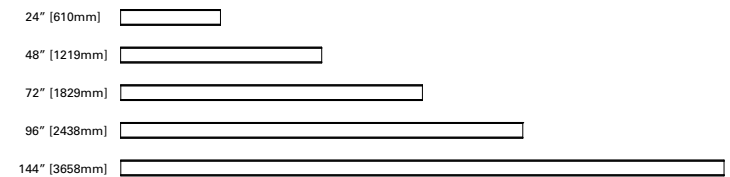

Note: End caps add .75" at each end. Sensor end caps add 1.5".

Order Information

SAMPLE ORDER NUMBER: SQ4-F-025U/075D-835-1D-UNV-STD-WAA-BSL6-W-AC48-T1-32

Domestic Preferences	Series	Shielding	Lumen Package Up (Lms/ft)	Lumen Package Down (Lms/ft)	CRI/CCT	Circuiting (In Cross Section)	Specialty Wiring
<b>[Blank]</b> =Standard <b>BAA</b> =Buy American Act	<b>SQ4</b> = Continua SQ 4" Suspended Direct/Indirect	<b>F</b> =Frosted Continuous Roll Lens <b>BB</b> =Black Baffle, Frosted Diffuser <b>WB</b> =White Baffle, Frosted Diffuser <b>PC3</b> =Perceive PARAMid <b>PP3</b> =Perceive Prism <b>PW1</b> =Perceive Waves <b>PR1</b> =Perceive Ripple <b>PH1</b> =Perceive Honeycomb ** <b>[Blank]</b> =Indirect Only	<b>0U</b> =No Uplight <b>025U</b> =250 Lumens/ft Up <b>050U</b> =500 Lumens/ft Up <b>075U</b> =750 Lumens/ft Up <b>100U</b> =1000 Lumens/ft Up <b>125U</b> =1250 Lumens/ft Up <b>150U</b> =1500 Lumens/ft Up <b>___U</b> =Specify **	<b>0D</b> =No Downlight <b>050D</b> =500 Lumens/ft Down <b>075D</b> =750 Lumens/ft Down <b>100D</b> =1000 Lumens/ft Down <b>125D</b> =1250 Lumens/ft Down <b>___D</b> =Specify **	<b>830</b> =3000K, 80CRI <b>835</b> =3500K, 80CRI <b>840</b> =4000K, 80CRI <b>930</b> =3000K, 90CRI <b>935</b> =3500K, 90CRI <b>940</b> =4000K, 90CRI <b>93050</b> =White Tuning 3000K-5000K <b>92765</b> =White Tuning 2700K-6500K	<b>1</b> =Single Circuit <b>2</b> =Dual Circuit (Ind. Up/Down Circuits)	<b>D</b> =None (Default Dimming) <b>E</b> =Emergency Circuit <b>S</b> =Secondary Circuit <b>N</b> =Secondary + Emergency Circuit
<b>Notes</b> Only product configurations with this designated prefix are built to be compliant with the Buy American Act of 1933 (BAA). Please refer to DOMESTIC PREFERENCES website for more information. Components shipped separately may be separately analyzed under domestic preference requirements.	<b>Notes</b>	<b>Notes</b> <b>F, PC3, PP3, PW1, PR1, PH1</b> : Single piece lens supplied up to 100-ft. ** Coming soon. Consult factory for availability.	<b>Notes</b> Custom lumen output available. Up (Indirect): Min = 250 Lms/ft Max = 1800 Lms/ft ** Consult factory to specify custom lumen package Not all lumen packages are available for every configuration. See Driver Availability tables for more details.	<b>Notes</b> Custom lumen output available. Down (Direct): Min = 200 Lms/ft Max = 1900 Lms/ft Consult factory to specify custom lumen package Not all lumen packages are available for every configuration. See Driver Availability tables for more details.	<b>Notes</b> White Tuning is 90CRI standard. Tunable White options to be used with WZA driver only. Must be used with two (2) 10V dimming control channels, 1 color, 1 intensity. Not compatible with other control or sensor options	<b>Notes</b> Refers to wiring in cross section. Dual circuit not available with secondary circuit or integrated sensor.	<b>Notes</b> Emergency and Secondary circuit section wiring are configured per unit (4ft, 6ft, 8ft, or 12ft). Emergency circuit option operates entire downlight portion of a specified unit.

Voltage	Driver/Dimming	Integral Sensor Options	Integral Emergency Device Options	Finish	Suspension Type	Ceiling Type	Run Length
<b>UNV</b> =Univeral (120V-277V) <b>347</b> =347V	<b>STD</b> =Standard 0-10V (1%-100%) <b>SR</b> =Sensor Ready (1%-100%) <b>SLT</b> =Fifth Light DALI (5%-100%) <b>LH</b> =Lutron HiLume 1% EcoSystems (LDE1) <b>L5</b> =Lutron 5-Series 5% EcoSystems (LDE5) <b>W2A</b> =White Tuning, 2ch, 0-10V Intensity and CCT Control	<b>WAA</b> =WaveLinX Wireless Integrated Sensor <b>WAB</b> =WaveLinX Lite Wireless Integrated Sensor <b>LWIPD1</b> =Enlightened Wireless Integrated Sensor	<b>BSL6</b> =Bodine 6-watt, 120V-277V Emergency Battery Pack, Self-Diagnostic, BSL6LST <b>EPC</b> =LVS Controls EPC UL924 Bypass Relay	<b>W</b> =White <b>S</b> =Silver <b>B</b> =Black <b>CC</b> =Custom Color	<b>AC48</b> =48" Aircraft cable <b>AC120</b> =120" Aircraft cable <b>AC240</b> =240" Aircraft cable <b>AC360</b> = 360" Aircraft cable	<b>T1</b> =15/16" T-Bar <b>T9</b> =9/16" T-Bar <b>TS</b> =Slotted T-Bar <b>JB</b> =Junction Box / Structure <b>UM</b> =Universal Ceiling Kit (T1, T9, JB) <b>___S</b> =Swivel at Canopy (___ = T1, T9, TS or JB)	<b>2</b> =2 ft <b>4</b> =4 ft <b>6</b> =6 ft <b>8</b> =8 ft <b>12</b> =12 ft <b>XX</b> =Specify Run Length
<b>Notes</b> Integral 347V driver with STD 0-10V option only.	<b>Notes</b> Not all driver options are available for every configuration. See Driver Availability tables for more details.	<b>Notes</b> WAA and WAB sensor must be used with "STD" driver. LWI sensor must be used with "SR" driver. Integrated Sensors combined with Emergency Circuit require one UL924 Bypass Relay per emergency fixture. SWPD1 has been renamed to WAA but remains the same sensor.	<b>Notes</b> EPC option used to bypass local control during outage. Must be used in conjunction with UL 1008 device (provided by others). Battery operates entire downlight portion of 4ft, 6ft fixtures and 4ft sections of 8ft and 12ft.	<b>Notes</b> <b>CC</b> =must denote RAL color number	<b>Notes</b> Please refer to ceiling interface diagrams for additional detail and dimensions.	<b>Notes</b> UM mounting accommodates 15/16" Grid, 9/16" Grid, 4" Octagonal J-Box, and Structure - Adder applies. White mounting hardware standard. For black mounting hardware, add "B" after ceiling type. (e.g. T1-B).	<b>Notes</b> See "Standard Row Configurations" table on Page 4 for continuous row length breakdowns. 2ft not available with integral sensors or emergency.

## Product Specifications

### Construction

- Single-piece extruded aluminum housing
- 3.75" x 3.75" square profile
- Die-formed 20 gauge cold rolled steel LED tray
- Driver accessible from above while fixture is suspended

### End Caps

- Die cast aluminum end caps allow for expansion of roll lens to eliminate light leak
- Attach mechanically to the end of the fixture without exposed fasteners
- Standard end cap adds 0.75" at each end. Integrated sensor end cap adds 1.5" at each end

### Lengths

- Available in 2-ft, 4-ft, 6-ft, 8-ft, and 12-ft sections
- Modular design eliminates the need for starter, intermediate, and end of run sections
- See table on page 4 for standard continuous row length breakdowns

### Finish

- Electrostatically applied polyester powder coat paint
- White, silver, and black finishes are standard.
- RAL custom colors are available

### Mounting

- Aircraft cable mounts on 2'-0", 4'-0", 6'-0", 8'-0", or 12'-0" centers, equal to the respective unit length
- Can also be adjusted along the length of the fixture to match existing mounting points
- Minimum suspension height from ceiling to top of fixture is 5"
- Fixture is balanced to allow for minimal leveling
- All sections are continuously wired with push-in connectors for fast installation
- Fixtures can be joined for straight continuous runs using supplied alignment pins and internal cast joiners
- Refer to installation instructions for various ceiling interface details

### Shielding

- **F:** Frosted continuous flexible roll lens creates seamless illumination along entire row length. Single piece roll lens up to 100 ft.
- **BB(Black)** and **WB(White):** Injection molded louvered baffles with 1.5" openings for glare management and frosted glare control diffuser to shield direct view of LEDs and lower UGR values and improve visual comfort.
- **PC3, PP3, PW1, PR1, PH1:** Proprietary Perceive™ optical system enables dynamic visual depth on a flat surface while providing glare-reducing performance with comfortable, high-quality illumination. Perceive continuous flexible roll lens creates seamless illumination along entire row length. Single piece roll lens up to 100 ft.

### Optics

- Precision engineered acrylic TIR optics on upper and lower LED light engines for optimal light distribution and uniformity
- 112.5° peak candela angle

### LED and Light Engine

- LEDs are available in 3000K, 3500K, 4000K
- CRI options of either ≥80CRI or ≥90CRI
- Lumen output will be affected - please refer to the lumen adjustment factor tables
- TM21 life at 60,000 hours up to L84 and calculated L70 exceeds 121,000 hrs.
- Drivers available in 120-277V and 347V

### Integrated Controls

- 0-10V dimming to 1% standard
- WaveLinx sensor compatible for IoT capability
- Enlighted sensor compatible for IoT capability
- DALI 2.0 and Lutron dimming available

### Emergency Options

- Emergency circuit option operates entire downlight portion of a specified unit (4 ft, 6 ft, 8 ft, or 12 ft)
- Optional 6-watt 120-277V integral emergency battery illuminates a 4 ft. down-light section
- 90-minute backup period for code compliance
- Test switch/indicator button located on the top side of the luminaire
- For approximate delivered lumens multiply the lumens per watt of the desired fixture by the wattage of the emergency battery pack (100 lm/W x 6 = 600 lumens)
- Battery is self-testing
- UL 924 emergency/generator transfer options available

### Weight

- 3.5 lbs. per foot

### Compliance

- cULus listed for damp locations
- Tested to IESNA LM-79 and LM-80
- RoHS compliant
- Stated life per TM21 standards
- Can be used for State of California Title 24 high efficacy luminaire
- DesignLights Consortium® Qualified and classified for DLC Standard and DLC Premium (refer to [www.designlights.org](http://www.designlights.org))

### Warranty

- Five year warranty standard [www.cooperlighting.com/legal](http://www.cooperlighting.com/legal)

**Continuous Lens**

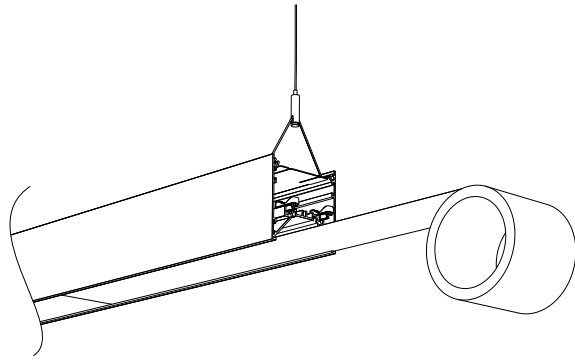

**Adjustable Mounting**

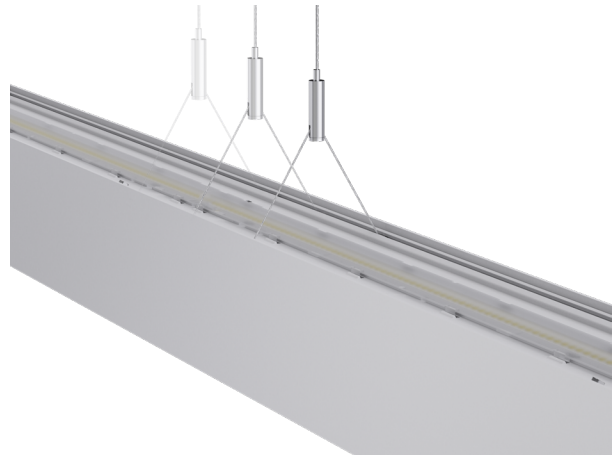

**Shielding & Finish Options**

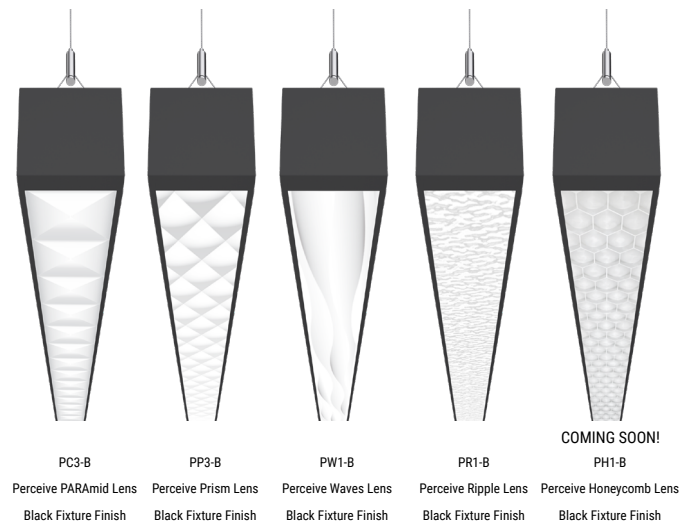
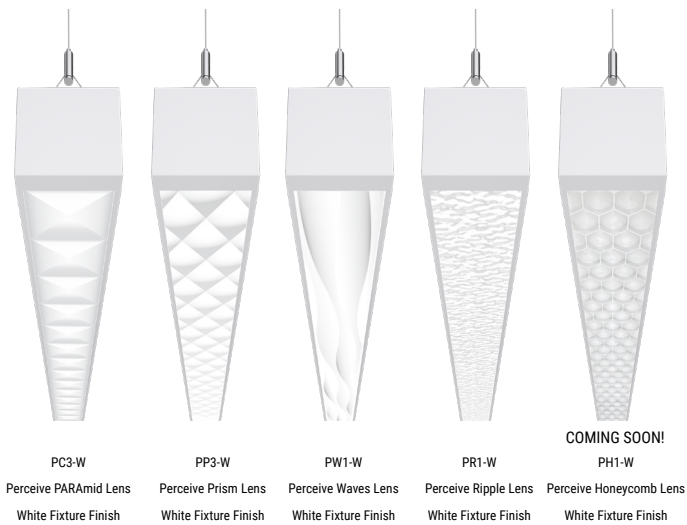
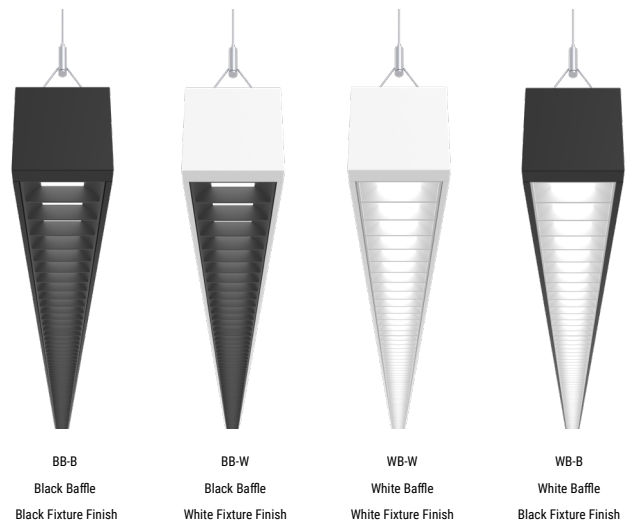
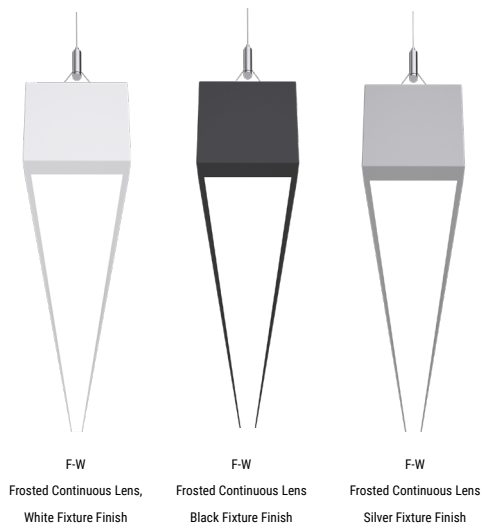

Note: All Finish and Shielding combinations are available. Not all are shown. Custom color housing finishes are also available.

Photometric Data

View IES files

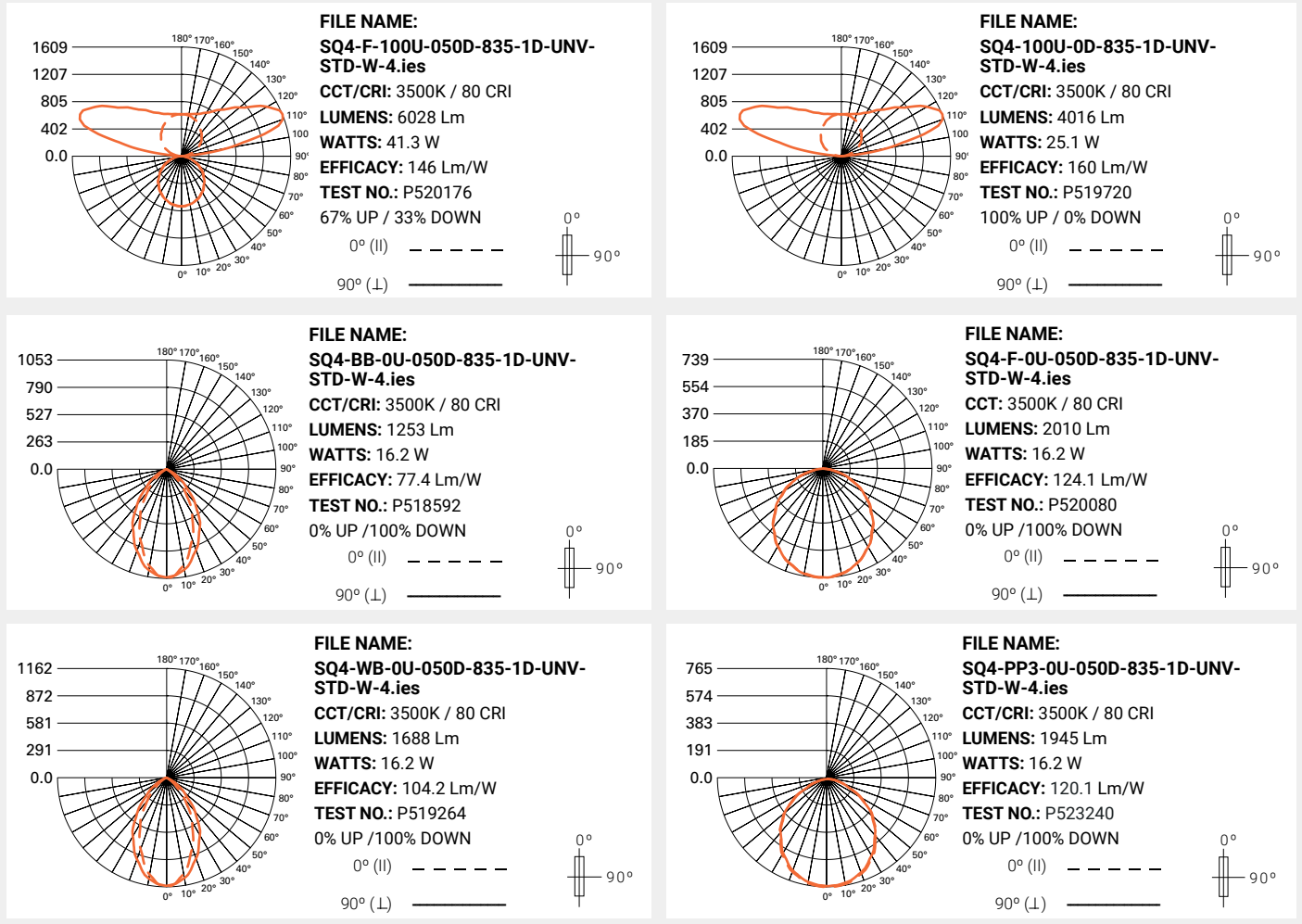

Note: Refer to IES files for more product data.

Lumen Maintenance

Ambient Temperature	TM-21 Lumen Maintenance (60,000 hours) <sup>(1)</sup>	Theoretical L70 (Hours) <sup>(2)</sup>
25°C	>84%	121,000

Notes: (1) Supported by IES TM-21 standards. (2) Theoretical values represent estimations commonly used; however, refer to the IES position on LED Product Lifetime Prediction, IES PS-10-18, that explains proper use of IES TM-21 and LM-80.

Color Data (3500K)

		80CRI	90CRI
TM-30-15	R <sub>f</sub>	84	89.7
	R <sub>g</sub>	97.2	97.2
CRI/CIE	R <sub>a</sub>	83.4	94.3
	R <sub>9</sub>	10.9	61.7

80CRI

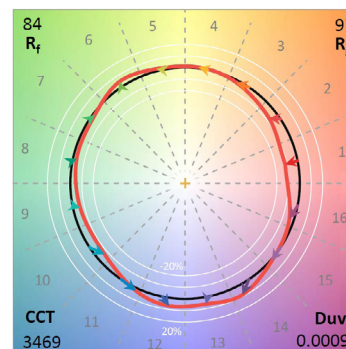

90CRI

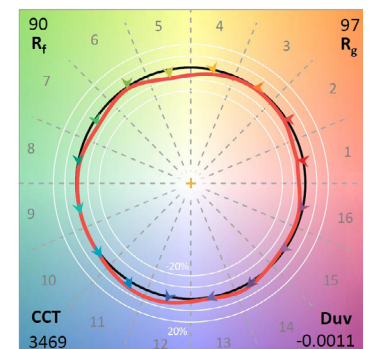

Energy and Performance Data - Frosted Lens and Indirect

Continua SQ4 Suspended Performance (3500K)							Glare	
Lumen Package	Lumens/ft Up	Lumens/ft Down	Lumens/ft Total	W/ft Total	Lm/W	Distribution (up%/down%)	UGR (1-2)(4-6)	MAX LUMINANCE (3-6)
0U-050D	0	499	499	4.0	124	0%/100%	22.3	6202
0U-075D	0	744	744	6.0	123	0%/100%	23.6	9167
0U-100D	0	983	983	8.2	120	0%/100%	24.6	12204
0U-125D	0	1259	1259	10.9	115	0%/100%	25.5	15513
025U-050D	242	499	741	5.5	135	33%/67%	19.8	6202
025U-075D	242	744	985	7.5	131	25%/75%	21.8	9167
025U-100D	242	983	1224	9.6	127	20%/80%	23.1	12204
025U-125D	242	1259	1500	12.4	121	16%/84%	24.2	15513
050U-050D	498	499	998	7.1	141	50%/50%	18.3	6202
050U-075D	498	744	1242	9.1	136	40%/60%	20.5	9167
050U-100D	498	983	1481	11.2	132	34%/66%	22	12204
050U-125D	498	1259	1757	14.0	125	28%/72%	23.3	15513
075U-050D	749	499	1248	8.6	144	60%/40%	17.2	6202
075U-075D	749	744	1492	10.7	140	50%/50%	19.6	9167
075U-100D	749	983	1731	12.8	135	43%/57%	21.2	12204
075U-125D	749	1259	2007	15.6	129	37%/63%	22.5	15513
100U-050D	1005	499	1504	10.3	146	67%/33%	16.4	6202
100U-075D	1005	744	1748	12.3	142	57%/43%	18.8	9167
100U-100D	1005	983	1987	14.4	138	51%/49%	20.5	12204
100U-125D	1005	1259	2263	17.2	132	44%/56%	21.9	15513
125U-050D	1251	499	1750	11.9	147	71%/29%	15.8	6202
125U-075D	1251	744	1994	14.0	143	63%/37%	18.2	9167
125U-100D	1251	983	2233	16.1	139	56%/44%	20	12204
125U-125D	1251	1259	2509	18.9	133	50%/50%	21.4	15513
150U-050D	1507	499	2006	13.9	144	75%/25%	15.2	6202
150U-075D	1507	744	2251	15.9	141	67%/33%	17.7	9167
150U-100D	1507	983	2490	18.0	138	61%/39%	19.5	12204
150U-125D	1507	1259	2766	20.8	133	54%/46%	21	15513
025U-0D	242	0	242	1.5	163	100%/0%		
050U-0D	498	0	498	3.1	162	100%/0%		
075U-0D	749	0	749	4.6	162	100%/0%		
100U-0D	1005	0	1005	6.3	160	100%/0%		
125U-0D	1251	0	1251	7.9	158	100%/0%		
150U-0D	1507	0	1507	9.9	153	100%/0%		



KEY:

	Meets WELL v2
TEXT	Meets LEED v4.1

Notes:

- (1) UGR values per CIE 190:2010 with 4H, 8H, Reflectance: 70% Ceiling, 50% Wall, 20% Ref. Plane
- (2) For other UGR data for room or reflective ceiling plans please see technical data on website.
- (3) Luminance measured at 45-90 degrees from nadir.
- (4) UGR and Luminance values that meet WELL v2 L04 requirements for Managing Glare are shown with green highlighted cell. (UGR < 16, Luminance < 6,000, Indirect-only)
- (5) UGR and Luminance values that meet LEED v4.1 requirements for Glare Control are shown with green text. (UGR < 19, Luminance < 7,000, Indirect-only)
- (6) For technical data of other configurations please see photometric section on website or click link at top-right

Lumen Adjustment Factors

CCT	3000K		3500K		4000K	
CRI	80+	90+	80+	90+	80+	90+
Lumen Multiplier	0.956	0.803	1.000	0.852	0.988	0.888
Melanopic Ratio	0.494	0.591	0.574	0.674	0.675	0.752

Example Calculation:

025U-075D / 3500K / 80 CRI  
Lumen Output selected = 985 lms/ft

3500K / 90 CRI Desired  
Lumen Adjustment Factor = 0.852

Adjusted Lumen Output = 985 lms/ft x 0.852 = 839 lms/ft

Energy and Performance Data - Perceive™ Lenses

Glare								
Lumen Package	PARAmid (PC3)		Prism (PP3)		Waves (PW1)		Ripple (PR1)	
	UGR (1-2)(4-6)	MAX LUMINANCE (3-6)	UGR (1-2)(4-6)	MAX LUMINANCE (3-6)	UGR (1-2)(4-6)	MAX LUMINANCE (3-6)	UGR (1-2)(4-6)	MAX LUMINANCE (3-6)
0U-050D	21.8	6194	21.1	6202	21.5	5959	20.7	6464
0U-075D	23.2	9130	22.5	9140	22.8	8782	22	9528
0U-100D	24.1	12131	23.5	12144	23.8	11669	23	12659
0U-125D	25	15480	24.3	15497	24.6	14891	23.9	16155
025U-050D	19.2	6194	18.6	6202	18.9	5959	18.1	6464
025U-075D	21.2	9130	20.5	9140	20.9	8782	20.1	9528
025U-100D	22.6	12131	21.9	12144	22.2	11669	21.4	12659
025U-125D	23.7	15480	23.1	15497	23.4	14891	22.6	16155
050U-050D	17.7	6194	17	6202	17.3	5959	16.5	6464
050U-075D	19.9	9130	19.2	9140	19.5	8782	18.8	9528
050U-100D	21.5	12131	20.8	12144	21.1	11669	20.3	12659
050U-125D	22.8	15480	22.1	15497	22.4	14891	21.6	16155
075U-050D	16.7	6194	16	6202	16.3	5959	15.5	6464
075U-075D	19	9130	18.3	9140	18.6	8782	17.8	9528
075U-100D	20.7	12131	20	12144	20.3	11669	19.5	12659
075U-125D	22	15480	21.3	15497	21.6	14891	20.8	16155
100U-050D	15.9	6194	15.2	6202	15.5	5959	14.7	6464
100U-075D	18.3	9130	17.6	9140	17.9	8782	17.1	9528
100U-100D	20	12131	19.3	12144	19.6	11669	18.8	12659
100U-125D	21.4	15480	20.7	15497	21	14891	20.2	16155
125U-050D	15.2	6194	14.5	6202	14.8	5959	14	6464
125U-075D	17.7	9130	17	9140	17.3	8782	16.5	9528
125U-100D	19.4	12131	18.7	12144	19	11669	18.2	12659
125U-125D	20.9	15480	20.2	15497	20.5	14891	19.7	16155
150U-050D	14.7	6194	14	6202	14.3	5959	13.5	6464
150U-075D	17.2	9130	16.5	9140	16.8	8782	16	9528
150U-100D	18.9	12131	18.2	12144	18.5	11669	17.7	12659
150U-125D	20.4	15480	19.7	15497	20	14891	19.2	16155



Notes:

- (1) UGR values per CIE 190:2010 with 4H, 8H, Reflectance: 70% Ceiling, 50% Wall, 20% Ref. Plane
- (2) For other UGR data for room or reflective ceiling plans please see technical data on website.
- (3) Luminance measured at 45-90 degrees from nadir.
- (4) UGR and Luminance values that meet WELL v2 L04 requirements for Managing Glare are shown with green highlighted cell. (UGR < 16, Luminance < 6,000, Indirect-only)
- (5) UGR and Luminance values that meet LEED v4.1 requirements for Glare Control are shown with green text. (UGR < 19, Luminance < 7,000, Indirect-only)
- (6) For technical data of other configurations please see photometric section on website or click link at top-right

KEY:

	Meets WELL v2
TEXT	Meets LEED v4.1

Lumen Adjustment Factors

CCT	3000K		3500K		4000K	
CRI	80+	90+	80+	90+	80+	90+
Lumen Multiplier	0.956	0.803	1.000	0.852	0.988	0.888
Melanopic Ratio	0.494	0.591	0.574	0.674	0.675	0.752

Example Calculation:

025U-075D / 3500K / 80 CRI  
Lumen Output selected = 985 lms/ft

3500K / 90 CRI/ Perceive Prism Lens Desired

Lumen Adjustment Factor = 0.852  
Lens Lumen Adjustment Factor (Direct Output) = 0.970

Adjusted Lumen Output:

Lumens Up = 242 lms/ft x 0.852 = 206 lms/ft  
Lumens Down = 744 lms/ft x 0.852 x 0.970 = 615 lms/ft  
Total Lumens = 206 lms/ft + 615 lms/ft = 821 lms/ft

Lens Lumen Multipliers (applied to Direct/Down output)- Perceive Lenses	
F = Frosted	1.000
PC3 = Perceive PARAmid	0.979
PP3 = Perceive Prism	0.970
PW1 = Perceive Waves	0.964
PR1 = Perceive Ripple	0.959



Energy and Performance Data - White Baffle (SQ4-WB)

Continua SQ4 Suspended Performance (3500K)							Glare	
Lumen Package	Lumens/ft Up	Lumens/ft Down	Lumens/ft Total	W/ft Total	Lm/W	Distribution (up%/down%)	UGR <sup>(1-2)/(4-6)</sup>	MAX LUMINANCE <sup>(3-6)</sup>
0U-050D	0	422	422	4.1	104	0%/100%	16.9	5194
0U-075D	0	623	623	6.0	104	0%/100%	18.2	7671
0U-100D	0	823	823	8.2	100	0%/100%	19.2	10122
0U-125D	0	1026	1026	10.9	94	0%/100%	20	12629
025U-050D	241	422	664	5.5	120	36%/64%	13.9	5194
025U-075D	241	623	865	7.5	116	28%/72%	16	7671
025U-100D	241	823	1064	9.7	110	23%/77%	17.4	10122
025U-125D	241	1026	1268	12.4	102	19%/81%	18.4	12629
050U-050D	498	422	920	7.1	129	54%/46%	12.3	5194
050U-075D	498	623	1121	9.1	124	44%/56%	14.6	7671
050U-100D	498	823	1321	11.3	117	38%/62%	16.1	10122
050U-125D	498	1026	1524	14.0	109	33%/67%	17.3	12629
075U-050D	748	422	1171	8.7	135	64%/36%	11.2	5194
075U-075D	748	623	1372	10.6	129	55%/45%	13.6	7671
075U-100D	748	823	1571	12.8	122	48%/52%	15.2	10122
075U-125D	748	1026	1775	15.5	114	42%/58%	16.5	12629
100U-050D	1004	422	1426	10.3	138	70%/30%	10.3	5194
100U-075D	1004	623	1627	12.3	133	62%/38%	12.8	7671
100U-100D	1004	823	1827	14.5	126	55%/45%	14.5	10122
100U-125D	1004	1026	2030	17.2	118	49%/51%	15.8	12629
125U-050D	1250	422	1672	12.0	140	75%/25%	9.7	5194
125U-075D	1250	623	1873	13.9	135	67%/33%	12.2	7671
125U-100D	1250	823	2072	16.1	129	60%/40%	13.9	10122
125U-125D	1250	1026	2276	18.8	121	55%/45%	15.3	12629
150U-050D	1506	422	1928	13.9	138	78%/22%	9.1	5194
150U-075D	1506	623	2129	15.9	134	71%/29%	11.6	7671
150U-100D	1506	823	2329	18.1	129	65%/35%	13.4	10122
150U-125D	1506	1026	2532	20.8	122	59%/41%	14.8	12629



Notes:

- (1) UGR values per CIE 190:2010 with 4H, 8H, Reflectance: 70% Ceiling, 50% Wall, 20% Ref. Plane
- (2) For other UGR data for room or reflective ceiling plans please see technical data on website.
- (3) Luminance measured at 45-90 degrees from nadir.
- (4) UGR and Luminance values that meet WELL v2 L04 requirements for Managing Glare are shown with green highlighted cell. (UGR < 16, Luminance < 6,000, Indirect-only)
- (5) UGR and Luminance values that meet LEED v4.1 requirements for Glare Control are shown with green text. (UGR < 19, Luminance < 7,000, Indirect-only)
- (6) For technical data of other configurations please see photometric section on website or click link at top-right

KEY:

	Meets WELL v2
TEXT	Meets LEED v4.1

Lumen Adjustment Factors

CCT	3000K		3500K		4000K	
	80+	90+	80+	90+	80+	90+
CRI						
Lumen Multiplier	0.956	0.803	1.000	0.852	0.988	0.888
Melanopic Ratio	0.494	0.591	0.574	0.674	0.675	0.752

Example Calculation:

025U-075D / 3500K / 80 CRI  
Lumen Output selected = 985 lms/ft

3500K / 90 CRI Desired  
Lumen Adjustment Factor = 0.852

Adjusted Lumen Output = 985 lms/ft x 0.852 = 839 lms/ft



**Energy and Performance Data - Black Baffle (SQ4-BB)**

Continua SQ4 Suspended Performance (3500K)							Glare	
Lumen Package	Lumens/ft Up	Lumens/ft Down	Lumens/ft Total	W/ft Total	Lm/W	Distribution (up%/down%)	UGR <sup>(1-2)/(4-6)</sup>	MAX LUMINANCE <sup>(3-6)</sup>
0U-050D	0	313	313	4.1	77	0%/100%	12.4	4231
0U-075D	0	463	463	6.0	77	0%/100%	13.8	6250
0U-100D	0	611	611	8.2	74	0%/100%	14.8	8248
0U-125D	0	762	762	10.9	70	0%/100%	15.5	10290
025U-050D	241	313	555	5.5	100	44%/56%	8.8	4231
025U-075D	241	463	704	7.5	94	34%/66%	11	6250
025U-100D	241	611	852	9.7	88	28%/72%	12.4	8248
025U-125D	241	762	1003	12.4	81	24%/76%	13.5	10290
050U-050D	498	313	811	7.1	114	61%/39%	6.9	4231
050U-075D	498	463	961	9.1	106	52%/48%	9.3	6250
050U-100D	498	611	1109	11.3	98	45%/55%	11	8248
050U-125D	498	762	1260	14.0	90	40%/60%	12.2	10290
075U-050D	748	313	1062	8.7	122	70%/30%	5.8	4231
075U-075D	748	463	1211	10.6	114	62%/38%	8.3	6250
075U-100D	748	611	1359	12.8	106	55%/45%	10	8248
075U-125D	748	762	1510	15.5	97	50%/50%	11.3	10290
100U-050D	1004	313	1317	10.3	128	76%/24%	4.9	4231
100U-075D	1004	463	1467	12.3	120	68%/32%	7.4	6250
100U-100D	1004	611	1615	14.5	112	62%/38%	9.2	8248
100U-125D	1004	762	1766	17.2	103	57%/43%	10.5	10290
125U-050D	1250	313	1563	12.0	131	80%/20%	4.2	4231
125U-075D	1250	463	1713	13.9	123	73%/27%	6.8	6250
125U-100D	1250	611	1861	16.1	115	67%/33%	8.6	8248
125U-125D	1250	762	2012	18.8	107	62%/38%	9.9	10290
150U-050D	1506	313	1819	13.9	131	83%/17%	3.6	4231
150U-075D	1506	463	1969	15.9	124	76%/24%	6.2	6250
150U-100D	1506	611	2117	18.1	117	71%/29%	8	8248
150U-125D	1506	762	2268	20.8	109	66%/34%	9.4	10290



**Notes:**

- (1) UGR values per CIE 190:2010 with 4H, 8H, Reflectance: 70% Ceiling, 50% Wall, 20% Ref. Plane
- (2) For other UGR data for room or reflective ceiling plans please see technical data on website.
- (3) Luminance measured at 45-90 degrees from nadir.
- (4) UGR and Luminance values that meet WELL v2 L04 requirements for Managing Glare are shown with green highlighted cell. (UGR < 16, Luminance < 6,000, Indirect-only)
- (5) UGR and Luminance values that meet LEED v4.1 requirements for Glare Control are shown with green text. (UGR < 19, Luminance < 7,000, Indirect-only)
- (6) For technical data of other configurations please see photometric section on website or click link at top-right

**KEY:**

	Meets WELL v2
TEXT	Meets LEED v4.1

**Lumen Adjustment Factors**

CCT	3000K		3500K		4000K	
CRI	80+	90+	80+	90+	80+	90+
Lumen Multiplier	0.956	0.803	1.000	0.852	0.988	0.888
Melanopic Ratio	0.494	0.591	0.574	0.674	0.675	0.752

**Example Calculation:**

025U-075D / 3500K / 80 CRI  
 Lumen Output selected = 985 lms/ft

3500K / 90 CRI Desired  
 Lumen Adjustment Factor = 0.852

Adjusted Lumen Output = 985 lms/ft x 0.852 = 839 lms/ft

**Control Systems**

- WaveLinx Wireless
- WaveLinx Wired
- WaveLinx Lite
- Enlighted
- iLumin Plus
- VividTune



The SQ4 with Integrated Sensor technology provides automatic energy savings without sacrificing performance. The SQ4 delivers superior lighting with integrated occupancy and daylighting controls. For standalone and controlled applications, the WaveLinx Lite integral sensor provides out-of-the-box functionality with no gateways required and factory startup is not needed. When more connectivity is required, the WaveLinx Wireless sensor meets modern code and utility requirements, delivers energy and cost savings, while enabling buildings to become smart buildings. The WaveLinx Wireless Connected Lighting System combined with Trellix provides an open IoT platform and infrastructure that connects intelligent sensors leveraging the real-estate of the physical light fixture to solve higher complexity problems to deliver actionable insights through the aggregation of valuable data.

For additional information integrated sensors and connected lighting, please visit [Cooper Lighting Solutions' Connected Lighting Website](#).

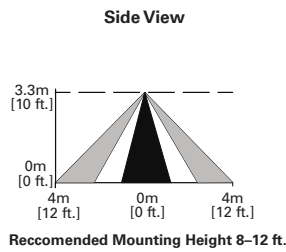
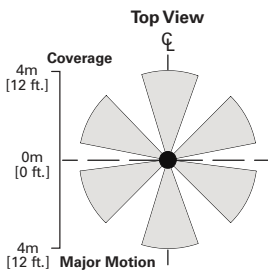

SQ4 Suspended with Integrated Sensor - Endcap

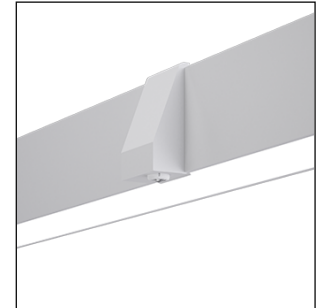

SQ4 Suspended with Integrated Sensor - Side Mount



**Standalone**



**Controlled**  
WaveLinx Lite



**Connected**  
WaveLinx Wireless



**Enterprise**  
Trellix

<b>Occupancy</b>	Yes	Yes	Yes	Yes
<b>Daylighting</b>	Yes	Yes	Yes	Yes
<b>Gateways</b>	-	-	1 WAC	300 WACs
<b>Devices</b>	-	50 per Area (1400 per site)	150 per WAC	45,000 per Core Enterprise
<b>Software</b>	-	WaveLinx Lite Mobile App	WaveLinx Mobile App	Trellix Core
<b>Areas</b>	-	28 per Site	16 per WAC	up to 4,800
<b>Zones</b>	-	16 per Area	16 per Area	up to 76,800
<b>Scheduling</b>	-	-	Local	Global
<b>VividTune™</b>	-	-	Yes	Yes
<b>Plug-Load Control</b>	-	-	Yes	Yes
<b>Integration</b>	-	-	-	BACnet, API
<b>Dashboards</b>	-	-	-	Energy, Occupancy
<b>Configuration</b>	-	Installer	Technician	Technician / IT

**SCALABILITY**

devices

areas

floors

buildings

**Default Integral Sensor Placement**

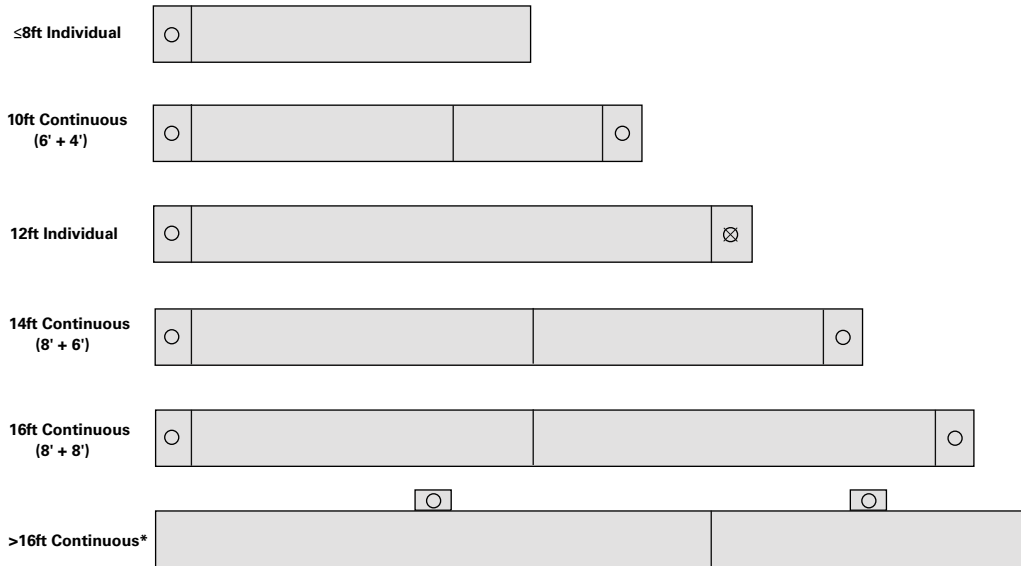

Note: \*See Standard Row Configuration table on Page 4.

- Standard Sensor with Luminaire Control
- ⊗ Auxiliary Sensor used for Sensor Coverage (wireless systems only)

**Standard Row Configurations**

Fixture Length	2'	4'	6'	8'	10'	12'	14'	16'	18'	20'	22'	24'	26'	28'	30'	32'	34'	36'	38'	40'	42'	44'	46'	48'	50'
2'	1																								
4'		1		1																					
6'			1	1		1		1		1		1		1		1		1		1		1		1	
8'				1		1	2		1	2		1	2		1	2		1	2		1	2		1	2
12'						1			1	1		2	1	1	2	2	1	3	2	2	3	3	2	4	3

Fixture Length	52'	54'	56'	58'	60'	62'	64'	66'	68'	70'	72'	74'	76'	78'	80'	82'	84'	86'	88'	90'	92'	94'	96'	98'	100'
4'																									
6'		1		1		1		1		1		1		1		1		1		1		1		1	
8'	2		1	2		1	2		1	2		1	2		1	2		1	2		1	2		1	2
12'	3	4	4	3	5	4	4	5	5	4	6	5	5	6	6	5	7	6	6	7	7	6	8	7	7



**SQ4 with VividTune Tunable White**

VividTune tunable white luminaires from Cooper Lighting Solutions deliver high-quality light in a broad range of continuously variable color temperatures and intensities. Create a dynamic environment by adjusting the ambient light warmer or cooler to influence mood, support the task at hand, or create a dramatic ambience. The ability to control correlated color temperature and intensity separately using simple controls is the next evolution of LED lighting for the commercial, educational, healthcare and hospitality space. The unparalleled flexibility and number of available lighting environments enable users to find the right light with tunable white.

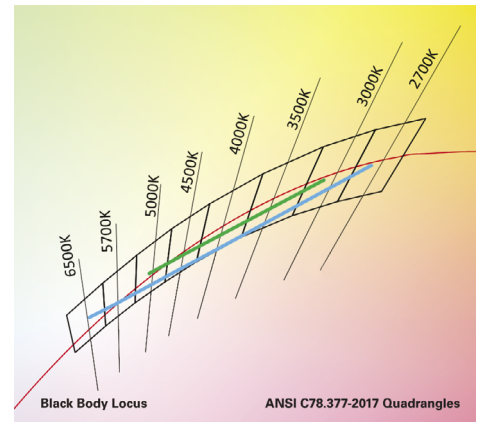

3000K - 5000K  
2700K - 6500K

**Performance Data**

Continua SQ4 Suspended Performance (3500K)						
Lumen Package	"Lumens/ft Up"	"Lumens/ft Down"	"Lumens/ft Total"	"W/ft Total"	Lm/W	Distribution (up%/down%)
0U-050D	0	510	510	5.2	98	0%/100%
0U-075D	0	753	753	7.9	95	0%/100%
0U-100D	0	994	994	10.6	94	0%/100%
0U-125D	0	1251	1251	13.9	90	0%/100%
025U-050D	449	510	958	8.8	109	47%/53%
025U-075D	449	753	1202	11.5	105	37%/63%
025U-100D	449	994	1443	14.2	102	31%/69%
025U-125D	449	1251	1700	17.5	97	26%/74%
050U-050D	504	510	1014	9.2	110	50%/50%
050U-075D	504	753	1257	11.9	106	40%/60%
050U-100D	504	994	1498	14.6	102	34%/66%
050U-125D	504	1251	1755	17.9	98	29%/71%
075U-050D	747	510	1257	11.1	113	59%/41%
075U-075D	747	753	1500	13.8	109	50%/50%
075U-100D	747	994	1741	16.5	105	43%/57%
075U-125D	747	1251	1999	19.8	101	37%/63%
100U-050D	996	510	1505	13.3	113	66%/34%
100U-075D	996	753	1748	16.0	109	57%/43%
100U-100D	996	994	1990	18.7	106	50%/50%
100U-125D	996	1251	2247	22.0	102	44%/56%
125U-050D	1247	510	1757	15.6	113	71%/29%
125U-075D	1247	753	2000	18.2	110	62%/38%
125U-100D	1247	994	2241	21.0	107	56%/44%
125U-125D	1247	1251	2498	24.2	103	50%/50%
150U-050D	1500	510	2010	18.0	112	75%/25%
150U-075D	1500	753	2253	20.7	109	67%/33%
150U-100D	1500	994	2494	23.4	107	60%/40%
150U-125D	1500	1251	2751	26.7	103	55%/45%
025U-0D	449	0	449	3.6	126	100%/0%
050U-0D	504	0	504	4.0	126	100%/0%
075U-0D	747	0	747	5.9	127	100%/0%
100U-0D	996	0	996	8.1	123	100%/0%
125U-0D	1247	0	1247	10.3	121	100%/0%
150U-0D	1500	0	1500	12.8	118	100%/0%

CCT Multiplier	90CRI 3000K-5000K	90CRI 2700K-6500K
2700K	-	0.954
3000K	0.981	0.974
3500K	1.000	0.997
4000K	1.011	1.016
4500K	1.018	1.032
5000K	1.025	1.044
5700K	-	1.058
6500K	-	1.068
6500K	-	-

**Example Calculation:**

025U-075D / 3000K-5000K tuned to 3500K  
Lumen Output selected = 1202 lms/ft

90CRI 3000K-5000K tuned to 4000K  
Lumen Adjustment Factor = 1.011

Adjusted Lumen Output = 1130 lms/ft x 1.011 = 1215 lms/ft

**Controlling VividTune Tunable White**

VividTune luminaires make tunable white more accessible by using simple and familiar controls. From wall dimmers to wireless controls, VividTune tunable white luminaires are compatible with industry standard 0-10V dimming controls. A single 0-10V dimming input is used to control intensity (brightness) while a second 0-10V dimming input is used to adjust CCT. For suggested control configurations, go to [www.cooperlighting.com](http://www.cooperlighting.com) for tunable white application guides.



**Driver Availability**

Lumen Package	'STD' 0-10V, UNV Qty of Drivers					'5LT' DALI / 'SR' Qty of Drivers					'L5' / 'LH' Lutron Qty of Drivers					'STD' 0-10V, 347V Qty of Drivers					'W2A' 2Ch WT 0-10V, UNV Qty of Drivers				
	2'	4'	6'	8'	12'	2'	4'	6'	8'	12'	2'	4'	6'	8'	12'	2'	4'	6'	8'	12'	2'	4'	6'	8'	12'
0U-050D	1	1	1	1	1	1	1	1	1	1	1	1	1	1	1	1	1	1	1	1	N/A	1	1	1	2
0U-075D	1	1	1	1	1	1	1	1	1	1	1	1	1	1	1	1	1	1	1	1	1	1	1	2	3
0U-100D	1	1	1	1	2	1	1	1	1	2	1	1	1	1	2	1	1	1	1	2	1	1	2	2	3
0U-125D	1	1	1	2	3	1	1	1	2	3	1	1	1	2	3	1	1	1	2	3	1	1	2	2	3
025U-050D	N/A	2	2	2	2	N/A	2	2	2	2	N/A	N/A	2	2	2	N/A	2	2	2	2	N/A	N/A	N/A	2	3
025U-075D	N/A	2	2	2	2	N/A	2	2	2	2	N/A	N/A	2	2	2	N/A	2	2	2	2	N/A	N/A	N/A	3	4
025U-100D	N/A	2	2	2	3	N/A	2	2	2	3	N/A	N/A	2	2	3	N/A	2	2	2	3	N/A	N/A	N/A	3	4
025U-125D	N/A	2	2	3	4	N/A	2	2	3	4	N/A	N/A	2	3	4	N/A	2	2	3	4	N/A	N/A	N/A	3	4
050U-050D	2	2	2	2	2	2	2	2	2	2	N/A	2	2	2	2	2	2	2	2	2	N/A	2	2	2	3
050U-075D	2	2	2	2	2	2	2	2	2	2	N/A	2	2	2	2	2	2	2	2	2	N/A	2	2	3	4
050U-100D	2	2	2	2	3	2	2	2	2	3	N/A	2	2	2	3	2	2	2	2	3	N/A	2	3	3	4
050U-125D	2	2	2	3	4	2	2	2	3	4	N/A	2	2	3	4	2	2	2	3	4	N/A	2	3	3	4
075U-050D	2	2	2	2	2	2	2	2	2	2	2	2	2	2	2	2	2	2	2	2	N/A	2	2	2	4
075U-075D	2	2	2	2	2	2	2	2	2	2	2	2	2	2	2	2	2	2	2	2	N/A	2	2	3	5
075U-100D	2	2	2	2	3	2	2	2	2	3	2	2	2	2	3	2	2	2	2	3	N/A	2	3	3	5
075U-125D	2	2	2	3	4	2	2	2	3	4	2	2	2	3	4	2	2	2	3	4	N/A	2	3	3	5
100U-050D	2	2	2	2	2	2	2	2	2	2	2	2	2	2	2	2	2	2	2	2	N/A	2	2	3	5
100U-075D	2	2	2	2	2	2	2	2	2	2	2	2	2	2	2	2	2	2	2	2	2	2	2	4	6
100U-100D	2	2	2	2	3	2	2	2	2	3	2	2	2	2	3	2	2	2	2	3	2	2	3	4	6
100U-125D	2	2	2	3	4	2	2	2	3	4	2	2	2	3	4	2	2	2	3	4	2	2	3	4	6
125U-050D	2	2	2	2	3	2	2	2	2	3	2	2	2	2	3	2	2	2	2	3	N/A	2	3	3	5
125U-075D	2	2	2	2	3	2	2	2	2	3	2	2	2	2	3	2	2	2	2	3	2	2	3	4	6
125U-100D	2	2	2	2	4	2	2	2	2	4	2	2	2	2	4	2	2	2	2	4	2	2	4	4	6
125U-125D	2	2	2	3	5	2	2	2	3	5	2	2	2	3	5	2	2	2	3	5	2	2	4	4	6
150U-050D	2	2	2	2	3	2	2	2	2	3	2	2	2	2	3	2	2	2	2	3	N/A	2	3	3	5
150U-075D	2	2	2	2	3	2	2	2	2	3	2	2	2	2	3	2	2	2	2	3	2	2	3	4	6
150U-100D	2	2	2	2	4	2	2	2	2	4	2	2	2	2	4	2	2	2	2	4	2	2	4	4	6
150U-125D	2	2	2	3	5	2	2	2	3	5	2	2	2	3	5	2	2	2	3	5	2	2	4	4	6
025U-0D	N/A	1	1	1	1	N/A	1	1	1	1	N/A	N/A	1	1	1	N/A	1	1	1	1	N/A	N/A	N/A	1	1
050U-0D	1	1	1	1	1	1	1	1	1	1	N/A	1	1	1	1	1	1	1	1	1	N/A	1	1	1	1
075U-0D	1	1	1	1	1	1	1	1	1	1	1	1	1	1	1	1	1	1	1	1	N/A	1	1	1	2
100U-0D	1	1	1	1	1	1	1	1	1	1	1	1	1	1	1	1	1	1	1	1	1	1	1	2	3
125U-0D	1	1	1	1	2	1	1	1	1	2	1	1	1	1	2	1	1	1	1	2	1	1	2	2	3
150U-0D	1	1	1	1	2	1	1	1	1	2	1	1	1	1	2	1	1	1	1	2	1	1	2	2	3