

Project		Catalog #		Type	
Prepared by		Notes		Date	

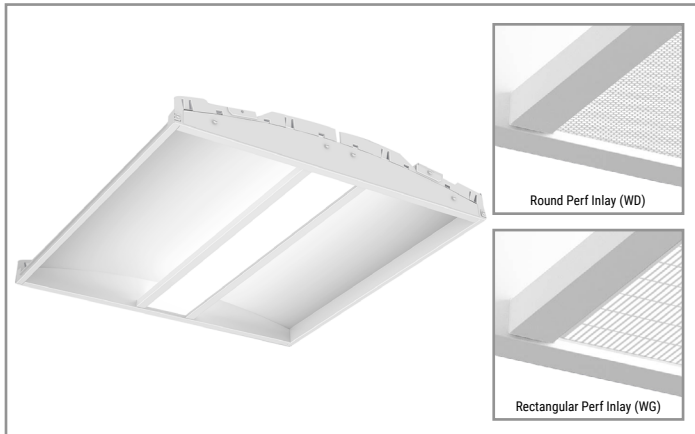

# Corelite

## Bridge - BRG

Fully Uniform  
WaveStream™ LED  
2' x 2' Recessed, 3-7/8" Depth

### Typical Applications

- Commerical Office Spaces • Schools • Hospitals • Retail Merchandising Areas

### Interactive Menu

- Order Information [page 2](#)
- Photometric Data [page 3](#)
- Energy and Performance Data [page 3](#)
- Connected Systems [page 4](#)
- Product Warranty

### Product Certification



### Product Features



### Top Product Features

- A traditional yet modern design with the latest in solid-state lighting technology
- Leverages our patented WaveStream Technology with AccuAim™ optics
- Optimal illumination in a ultra-minimalistic shallow recessed fixture
- Customize the luminaire aesthetic with three optional shielding inlays
- Integrated sensor systems - occupancy, daylight and IoT connectivity
- Options to meet Buy American and other domestic preference requirements

### Dimensions

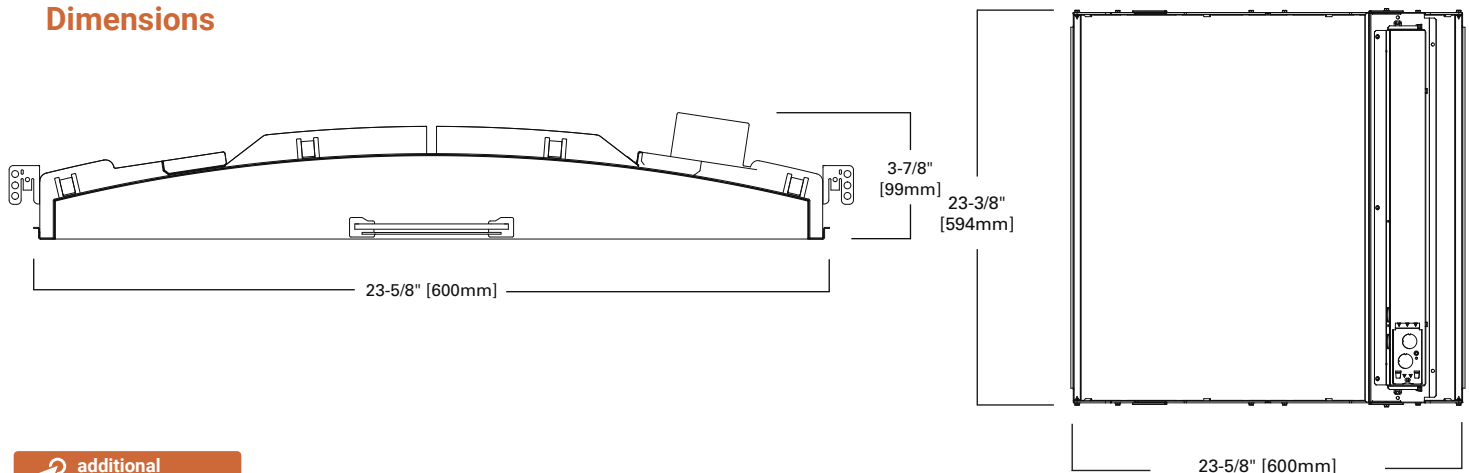

[additional product diagrams](#)

Order Information

SAMPLE ORDER NUMBER: BRG-WS-3L35-LD2-UNV-22-T1-STD-SVPD1-EL14W-AR

Domestic Preferences	Series	Optics/Shielding	Light Level	Color Temperature	LED Version	Input Voltage
Domestic Preferences	Series <sup>(1)</sup>	Optics/Shielding	Light Level (2x2 Nominal delivered lumens)	Color Temperature	LED Version	Input Voltage
<b>[Blank]</b> =Standard <b>BAA</b> =Buy American Act <b>TAA</b> =Trade Agreements Act	<b>BRG</b> =Bridge Recessed	<b>WS</b> =WaveStream Fully Uniform <b>WD</b> =WaveStream with Round Perf Inlay <b>WG</b> =WaveStream with Rectangular Perf Inlay <b>WN</b> =WaveStream with Nano-Prism Perf Inlay	<b>1</b> =Light Level 1 (2000 Lms, 19W) <b>2</b> =Light Level 2 (2500 Lms, 23W) <b>3</b> =Light Level 3 (3000 Lms, 29W) <b>4</b> =Light Level 4 (3500 Lms, 34W) <b>5</b> =Light Level 5 (4000 Lms, 39W) <b>6</b> =Light Level 6 (4500 Lms, 46W)	<b>L30</b> =LED 3000K, 80+ CRI <b>L35</b> =LED 3500K, 80+ CRI <b>L40</b> =LED 4000K, 80+ CRI	<b>LD2</b> =LED 2.0	<b>UNV</b> =Universal (120V-277V) <b>347</b> =347V <sup>(2)</sup> <b>48V</b> =48V Low-voltage (Class 2)
<b>Notes</b> Only product configurations with these designated prefixes are built to be compliant with the Buy American Act of 1933 (BAA) or Trade Agreements Act of 1979 (TAA), respectively. Please refer to DOMESTIC PREFERENCES website for more information. Components shipped separately may be separately analyzed under domestic preference requirements.	<b>Notes</b>	<b>Notes</b>	<b>Notes</b>	<b>Notes</b>	<b>Notes</b>	<b>Notes</b> <sup>(2)</sup> Integral 347V electronic driver with STD 0-10V option only. Factory supplied remote transformer for all other driver/dimming options.

Size	Ceiling Type	Driver Type	Integral Sensor	Emergency	Options
Size	Ceiling Type	Driver Type	Integral Sensor	Emergency	Options
<b>22=2'x2'</b>	<b>T1=1" T-Bar, Slot Grid, and 9/16" Tegular <sup>(3)</sup></b> <b>T9=9/16" T-Bar (Flush)</b>	<b>STD</b> =Standard 0-10V (1%-100%) <b>SR</b> =Sensor-ready for LWIPD1 (1%-100%) <b>5LT</b> =Fifth Light DALI (5%-100%) <b>LV1</b> =DLVP (0%-100%) <b>STP</b> =Step Dimming (Bi-Level, 50%) <b>LH</b> =Lutron HiLume 1% EcoSystems (LDE1)	<b>[Blank]</b> =No Sensor <b>WAA</b> =WaveLinX Wireless Integrated Sensor <sup>(A)</sup> <b>WAB</b> =WaveLinX Lite Wireless Integrated Sensor <sup>(B)</sup> <b>WLA</b> =Low-voltage Integrated Sensor <sup>(C)</sup> <b>SVPD1</b> =0-10V Stand-alone Integrated Sensor <sup>(D)</sup>	<b>EL14W</b> =14-watt 120V-277V Integral EM Battery Pack <sup>(12)</sup> <b>GTD2</b> =Bodine Generator Transfer Device <sup>(13)</sup>	<b>AR</b> =Air Return <b>CP</b> =Chicago Plenum <sup>(14)</sup> <b>W6</b> =6' Whip Flex <b>W12</b> =12' Whip Flex
<b>Notes</b>	<b>Notes</b> <sup>(3)</sup> "T1" ceiling type is compatible with Metalux DF Series Drywall Frame Kits and Metalux Universal Surface Mount Kits, ordered separately from Metalux. For 1x4 drywall frame kit, order part #DF-14-W. For 1x4 surface mount kit, order part #SK-14-WT. Refer to the surface mount kit specification sheet for more information.	<b>Notes</b> <sup>(5)</sup> 1x4: STP driver not available in Light Levels 1 and 2. <sup>(6)</sup> 1x4: Two HCD drivers required for Light Level 5. <sup>(7)</sup> 1x4: Two 5LTHD drivers required for Light Level 5. <sup>(8)</sup> 1x4: Two STP drivers required for Light Level 5.	<b>Notes</b> Integrated options must be used in conjunction with the associated system and may not be compatible with other options or accessories. Please refer to the following: (A) Consult WaveLinX system pages for additional details and compatibility. (B) WaveLinX Lite devices are not currently compatible with the WaveLinX Wireless Area Controller. Consult WaveLinX Lite system pages for additional details and compatibility. (C) Consult DLVP system pages for additional details and compatibility. (D) Consult SVPD series system pages for additional details and compatibility.	<b>Notes</b> <sup>(12)</sup> Integral emergency battery pack is 14W maximum, 90 minute output. A test switch/indicator button can be tested safely from the ground using a laser pointer, while the patented EZ Key prevents accidental discharge of the battery during construction. For approximate delivered lumens multiply the lumens per watt of the desired fixture by the wattage of the emergency battery pack (100 lm/W x 14=1400 lumens). Emergency battery pack not available with two driver configurations. <sup>(13)</sup> Used to transfer fixture to secondary power source for life-safety operation. When used with a dimming fixture, two devices are required to ensure control is disabled while operating under emergency power. Product height with transfer device is 5" (126mm).	<b>Notes</b> <sup>(14)</sup> Chicago plenum not available with GTD.

Product Specifications

Construction

- Shallow 3-7/8" deep housing is a 22 gauge steel
- Injection molded high-reflectance polycarbonate end plates securely attached
- WaveStream light engine with extruded aluminum heatsinks span across the bottom of the luminaire
- Drivers can be accessed via plenum
- Large access plate for supply connection

Optics

- Optical grade acrylic embedded with patented WaveStream Accu-Aim™ optics
- Optimal distribution, excellent uniformity, and high performance
- Center light engine becomes virtually clear in the off-state

Shielding

- Perf pattern and nano-prismatic inlays are available
- Perf inlay available in round or rectangular pattern
- Nano-prismatic inlay is a high light transmission material offering additional brightness mitigation

Finish

- Fixture housing and back reflector are high reflectance white

- Electrostatically applied polyester powder coat paint for durability and luminous uniformity
- Injection molded end plates are color matched

LED and Light Engine

- LED's are available in 3000K, 3500K, 4000K
- Long-life LED system coupled with electrical driver to deliver optimal performance
- Projected life is 100,000 at 80% lumen output
- Typical CRI ≥ 85

Integrated Controls

- 0-10V dimming to 1% standard
- WaveLinX wireless sensor compatible for standalone, controlled, connected, and IoT capability
- SVPD sensor compatible for standalone functionality
- Low-voltage sensor and driver compatible for DLVP applications
- DALI 2.0, Lutron, and step-dimming available

Mounting

- Universal flange design works with most lay-in ceiling types
- Integral pry-out tabs secure luminaire to ceiling grid from above

- Fixture offers tie-in locations for tie-wire on all corners
- Consult local code for appropriate tie-wire recommendations
- See Technical Notes section for drywall frame kit and surface mount kit options

Weight

- 12.0 lbs.

Compliance

- IC rated for insulation contact
- cULus listed for damp locations
- RoHS compliant
- Tested to IESNA LM-79 and LM-80
- Stated life per TM21 standards
- Can be used for State of California Title 24 high efficacy luminaire

Warranty

- Five year warranty standard. Optional ten year warranty available.

Photometric Data

[View IES files](#)

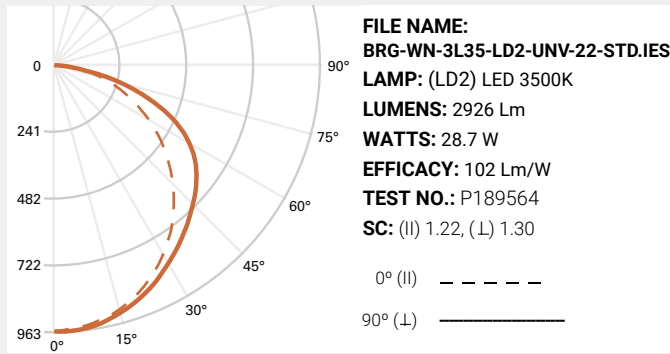
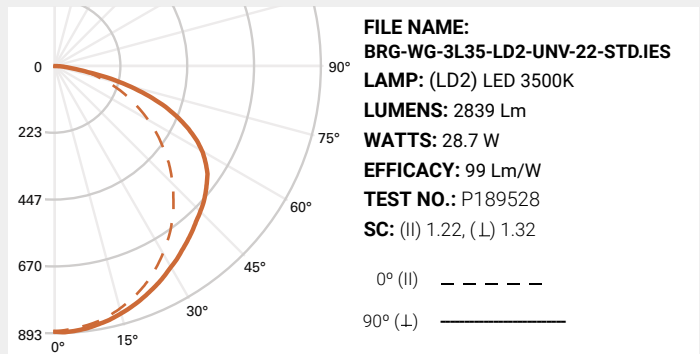
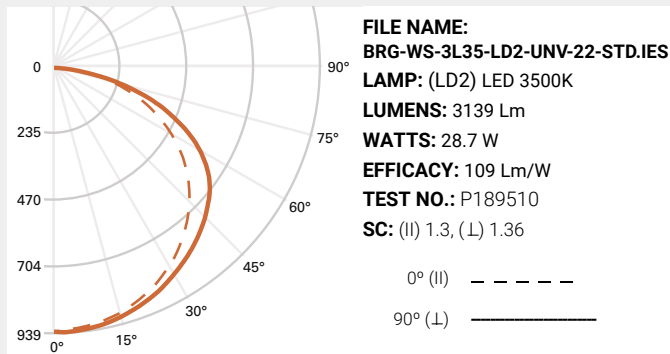

Note: Refer to IES files for more product data.

Energy and Performance Data

2x2 Bridge Light Level Outputs and Distributions (3500K)				
Series	Light Level	Delivered Lumens	Wattage	Efficacy (LPW)
BRG-WS	1	2100	18.6	113
	2	2572	23.1	112
	3	3139	28.7	109
	4	3637	33.8	108
	5	4096	39.1	105
	6	4622	45.7	101
BRG-WD	1	1894	18.6	102
	2	2320	23.1	101
	3	2831	28.7	99
	4	3281	33.8	97
	5	3695	39.1	94
	6	4169	45.7	91
BRG-WG	1	1899	18.6	102
	2	2326	23.1	101
	3	2839	28.7	99
	4	3289	33.8	97
	5	3704	39.1	95
	6	4180	45.7	92
BRG-WN	1	1958	18.6	105
	2	2398	23.1	104
	3	2926	28.7	102
	4	3390	33.8	100
	5	3818	39.1	98
	6	4308	45.7	94

Lumen Maintenance

Ambient Temperature	TM-21 Lumen Maintenance (100,000 hours)	Theoretical L70 (Hours)
25°C	>80%	115,000

Inlay Options

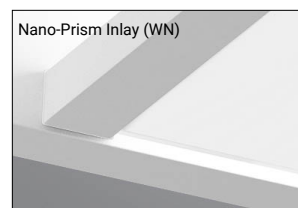
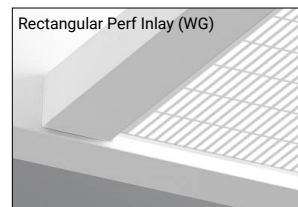
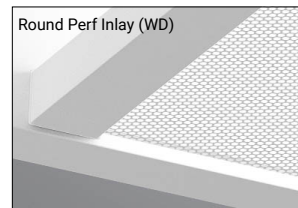

**Control Systems**

- WaveLinx Wireless
- WaveLinx Wired
- WaveLinx Lite
- DVLP



The Bridge BRG with Integrated Sensor technology provides automatic energy savings without sacrificing performance. The Bridge BRG delivers superior lighting with integrated occupancy and daylighting controls.

For standalone and controlled applications, the WaveLinx Lite integral sensor provides out-of-the-box functionality with no gateways required and factory startup is not needed. When more connectivity is required, the WaveLinx Wireless sensor meets modern code and utility requirements, delivers energy and cost savings, while enabling buildings to become smart buildings.

The WaveLinx Wireless Connected Lighting System combined with Trellix provides an open IoT platform and infrastructure that connects intelligent sensors leveraging the real-estate of the physical light fixture to solve higher complexity problems to deliver actionable insights through the aggregation of valuable data.

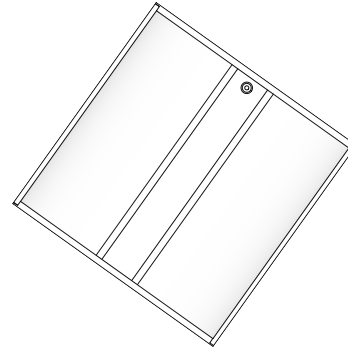
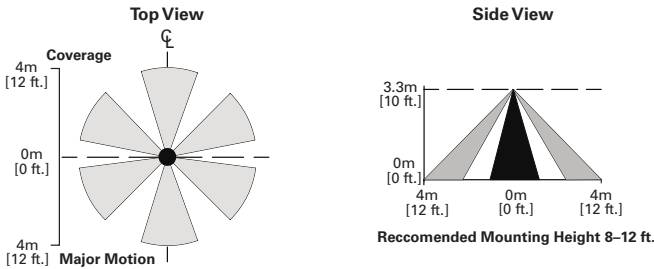

**Systems comparison chart**

Cooper Lighting Solutions provides many lighting system solutions designed to satisfy code requirements and meet the unique needs of any project.



	Standalone	Controlled WaveLinx Lite	Connected WaveLinx Wireless	Enterprise Trellix
Occupancy	Yes	Yes	Yes	Yes
Daylighting	Yes	Yes	Yes	Yes
Gateways	-	-	1 WAC	300 WACs
Devices	-	50 per Area (1400 per site)	150 per WAC	45,000 per Core Enterprise
Software	-	WaveLinx Lite Mobile App	WaveLinx Mobile App	Trellix Core
Areas	-	28 per Site	16 per WAC	up to 4,800
Zones	-	16 per Area	16 per Area	up to 76,800
Scheduling	-	-	Local	Global
VividTune™	-	-	Yes	Yes
Plug-Load Control	-	-	Yes	Yes
Integration	-	-	-	BACnet, API
Dashboards	-	-	-	Energy, Occupancy
Configuration	-	Installer	Technician	Technician / IT

**SCALABILITY**

