

DESCRIPTION

The classic lines and sophisticated construction of the Vision Wall luminaire make it an ideal complement to architectural site design. Offering LED technology across the site, flood and wall mounted fixtures the Vision series provides true family scaling in both physical form and lumen capability for architectural site lighting applications. UL/cUL listed for use in wet locations.

Catalog #		Type	
Project		Date	
Comments			
Prepared by			

SPECIFICATION FEATURES

Construction

HOUSING: One piece die-cast aluminum construction for precise tolerance control and repeatability in manufacturing. Integral aluminum heat sink provides superior thermal heat transfer in +40°C ambient environments. **DOOR:** Die-cast aluminum door maintains a nominal .125" thickness and features concealed hinging to the housing. Door frame is hinged and secured to the housing via four captive stainless steel Allen head fasteners.

Optics

Choice of six patented, high-efficiency AccuLED Optic distributions. Optics are precisely designed to shape the light output, maximizing efficiency and application spacing. AccuLED Optic technology creates consistent distributions with the scalability to meet customized application requirements. Offered Standard in 4000K (+/- 275K) CCT minimum 70 CRI. Optional 3000K CCT, 70 or 80 CRI.

Electrical

LED drivers mount to die-cast aluminum back housing for optimal heat sinking, operation efficacy, and prolonged life. Standard drivers feature electronic universal voltage (120-277V 50/60Hz), 347V 60Hz or 480V 60Hz operation. 480V is compatible for use with 480V Wye systems only. Greater than 0.9 power factor, less than 20% harmonic distortion, and is suitable for operation in -40°C to 40°C ambient environments. All fixtures are shipped standard with 10kV/10kA common – and differential – mode surge protection. LightBARs feature an IP66 enclosure rating and maintain greater than 95% lumen maintenance at 60,000 hours per IESNA TM-21.

Mounting

Standard zinc plated attachment plate fits directly to 4" J-Box. Two threaded studs with locking nuts allow for fixture mounting via keyhole slots on backside of housing. Mounting plate features

one-piece EPDM gasket on either side of plate to firmly seal fixture wall surface, preventing entry of moisture and particulates. Optional mounting arrangements include an embedded mount bracket, or cast aluminum surface conduit adapter, each available as accessories.

Finish

Housing is finished in five-stage super premium TGIC polyester powder coat paint, 2.5 mil nominal thickness for superior protection against fade and wear. The LightBAR™ cover plates are standard white and may be specified to match finish of luminaire housing standard colors include black, bronze, grey, white, dark platinum and graphite metallic. RAL and custom color matches available. Consult Outdoor Architectural Colors brochure for a complete selection. Options to meet Buy American Act requirements

Warranty

Five-year warranty.



VWM VISION WALL MEDIUM LED

1 - 5 LightBARs
Solid State LED

ARCHITECTURAL
WALL LUMINAIRE

DIMENSIONS

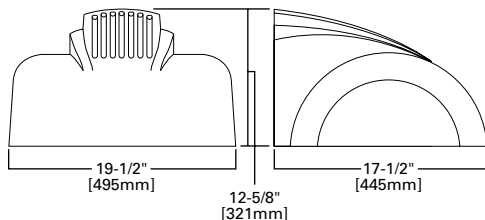

CERTIFICATION DATA

U.L./ cUL Listed
IP66 LightBARs
LM79 / LM80 Compliant
ISO 9001

ENERGY DATA

Electronic LED Driver
>0.9 Power Factor
<20% Total Harmonic Distortion
120-277V/50 & 60Hz, 347V/60Hz,
480V/60Hz
-40°C Minimum Temperature
40°C Ambient Temperature Rating

SHIPPING DATA

Approximate Net Weight
45 lbs. (20.45 kgs.)

ORDERING INFORMATION

Sample Number: VWM-E02-LED-E1-SL3-GM

Product Family	Number of LightBARs ^{1,2}	Lamp Type	Voltage	Distribution	Color ⁴
VWM=Vision Wall Medium BAA-VWM=Vision Wall Medium Buy American Act Compliant ¹³	E01=(1) 21 LED LightBAR E02=(2) 21 LED LightBARs E03=(3) 21 LED LightBARs E04=(4) 21 LED LightBARs E05=(5) 21 LED LightBARs F01=(1) 7 LED LightBAR F02=(2) 7 LED LightBARs F03=(3) 7 LED LightBARs F04=(4) 7 LED LightBARs F05=(5) 7 LED LightBARs	LED=Solid State Light Emitting Diodes	D1=0-10V Dimming, 120-277V ¹ 347=347V 480=480V ³	SL2=Type II w/Spill Control SL3=Type III w/Spill Control SL4=Type IV w/Spill Control RW=Rectangular Wide SLL=90° Spill Light Eliminator Left SLR=90° Spill Light Eliminator Right	AP=Grey BZ=Bronze BK=Black DP=Dark Platinum GM=Graphite Metallic WH=White
Options (Add as Suffix)			Accessories (Order Separately) ¹⁴		
F=Single Fused (120, 277 or 347V. Must Specify Voltage) FF=Double Fused (208, 240 or 480V. Must Specify Voltage) PC=Button Type Photocontrol (120, 208, 240 or 277V. Must Specify Voltage) 7030=70 CRI / 3000K CCT ⁵ 8030=80 CRI / 3000K CCT ⁵ MS-LXX=Motion Sensor for On/Off Operation ^{6,7,8} MS/DIM-LXX=Motion Sensor for Dimming Operation ^{6,7,8} LWR-LW=Enlighted Wireless Sensor, Wide Lens for 8'-16' Mounting Height ^{8,9,10} LWR-LN=Enlighted Wireless Sensor, Narrow Lens for 16'-20' Mounting Height ^{8,9,10} TP=Tamper Resistant Hardware LCF=LightBAR Cover Plate Matches Housing Finish HSS=Factory Installed House Side Shield ¹¹			MA1253=10kV Circuit Module Replacement VWM/EM=Embedded Mount LB/HSS-7=Field Installed House Side Shield for "E" LightBARs ¹² LB/HSS-21=Field Installed House Side Shield for "F" LightBARs ¹²		

- NOTES:**
- Standard 4000 cct, 70CRI min. 0-10v dimming driver standard for 120-277v.
 - 21 LED LightBAR powered by 350mA and 7 LED LightBAR powered by 1A.
 - Only for use with 480V Wye systems. Per NEC, not for use with ungrounded systems, impedance grounded systems or corner grounded systems (commonly known as Three Phase Three Wire Delta, Three Phase High Leg Delta and Three Phase Corner Grounded Delta systems).
 - Custom and RAL color matching available upon request. Consult your lighting representative at Cooper Lighting Solutions for more information.
 - Extended lead times apply. See website for IES files.
 - The FSR-100 configuration tool is required to adjust parameters including high and low modes, sensitivity, time delay, cutoff and more. Consult your lighting representative at Cooper Lighting Solutions for more information.
 - Replace LXX with mounting height in feet for proper lens selection (e.g., L8=8' mounting height). L8, L20, L40, and L40W are available options.
 - Includes integral photosensor.
 - Enlighted wireless sensors are factory installed requiring network components in appropriate quantities. See www.cooperlighting.com for Enlighted application information.
 - Bronze sensor is shipped with bronze fixtures. White sensor shipped on all other housing color options.
 - Only for use with SL2, SL3 and SL4 distributions. Not available with L90 and R90 options.
 - One required for each LightBAR. Not available with L90 or R90 options.
 - Only product configurations with this designated prefix are built to be compliant with the Buy American Act of 1933 (BAA). Please refer to [DOMESTIC PREFERENCES](#) website for more information. Components shipped separately may be separately analyzed under domestic preference requirements.
 - Accessories sold separately will be separately analyzed under domestic preference requirements. Consult factory for further information.

POWER AND LUMENS BY BAR COUNT (21 LED LIGHTBAR)

Number of LightBARs	E01	E02	E03	E04	E05	
Drive Current	350mA Drive Current					
Power (Watts)	25W	52W	75W	97W	127W	
Current @ 120V (A)	0.22	0.44	0.63	0.82	1.07	
Current @ 277V (A)	0.10	0.20	0.28	0.36	0.48	
Power (Watts)	31W	58W	82W	99W	132W	
Current @ 347V (A)	0.11	0.19	0.28	0.29	0.39	
Current @ 480V (A)	0.09	0.15	0.20	0.21	0.30	
SL2	Lumens	3,055	6,110	9,165	12,220	15,275
	BUG Rating	B1-U0-G1	B1-U0-G2	B2-U0-G2	B2-U0-G2	B3-U0-G3
SL3	Lumens	3,036	6,072	9,108	12,145	15,181
	BUG Rating	B1-U0-G1	B1-U0-G2	B2-U0-G2	B2-U0-G2	B2-U0-G3
SL4	Lumens	2,954	5,908	8,862	11,816	14,771
	BUG Rating	B1-U0-G1	B1-U0-G2	B2-U0-G2	B2-U0-G2	B2-U0-G3
RW	Lumens	3,124	6,248	9,372	12,496	15,620
	BUG Rating	B2-U0-G2	B3-U0-G3	B3-U0-G3	B4-U0-G4	B4-U0-G4
SLL/SLR	Lumens	2,782	5,565	8,347	11,130	13,912
	BUG Rating	B1-U0-G1	B1-U0-G2	B1-U0-G3	B2-U0-G3	B2-U0-G3

POWER AND LUMENS BY BAR COUNT (7 LED LIGHTBAR)

Number of LightBARs	F01	F02	F03	F04	F05	
Drive Current	1A Drive Current					
Power (Watts)	26W	55W	78W	102W	133W	
Current @ 120V (A)	0.22	0.46	0.66	0.86	1.12	
Current @ 277V (A)	0.10	0.21	0.29	0.37	0.50	
Power (Watts)	32W	60W	85W	105W	137W	
Current @ 347V (A)	0.11	0.19	0.28	0.30	0.41	
Current @ 480V (A)	0.09	0.15	0.21	0.22	0.31	
SL2	Lumens	2,522	5,044	7,566	10,088	12,610
	BUG Rating	B1-U0-G1	B1-U0-G1	B2-U0-G2	B2-U0-G2	B2-U0-G2
SL3	Lumens	2,506	5,013	7,519	10,026	12,532
	BUG Rating	B1-U0-G1	B1-U0-G1	B1-U0-G2	B2-U0-G2	B2-U0-G2
SL4	Lumens	2,439	4,877	7,316	9,755	12,193
	BUG Rating	B1-U0-G1	B1-U0-G2	B1-U0-G2	B2-U0-G2	B2-U0-G2
RW	Lumens	2,579	5,158	7,737	10,316	12,894
	BUG Rating	B2-U0-G2	B3-U0-G3	B3-U0-G3	B3-U0-G3	B4-U0-G4
SLL/SLR	Lumens	2,297	4,594	6,891	9,188	11,485
	BUG Rating	B1-U0-G1	B1-U0-G2	B1-U0-G2	B1-U0-G3	B2-U0-G3

LUMEN MAINTENANCE

Ambient Temperature	25,000 Hours*	50,000 Hours*	60,000 Hours*	100,000 Hours	Theoretical L70 (Hours)
25°C	> 99%	> 97%	> 96%	> 93%	> 450,000
40°C	> 98%	> 97%	> 96%	> 92%	> 425,000
50°C	> 97%	> 96%	> 95%	> 91%	> 400,000

* Per IESNA TM-21 data.

LUMEN MULTIPLIER

Ambient Temperature	Lumen Multiplier
10°C	1.02
15°C	1.01
25°C	1.00
40°C	0.99

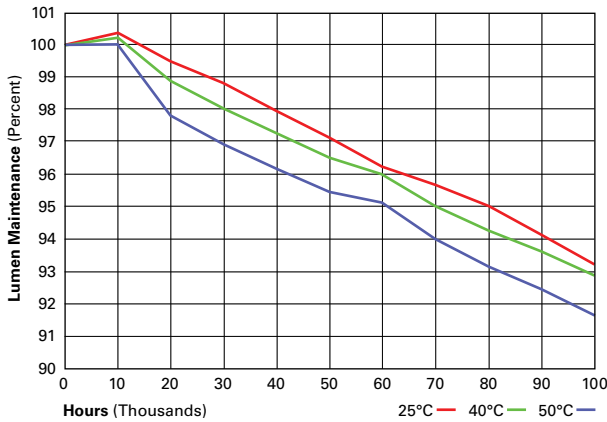

ACCESSORIES (ORDER SEPARATELY)

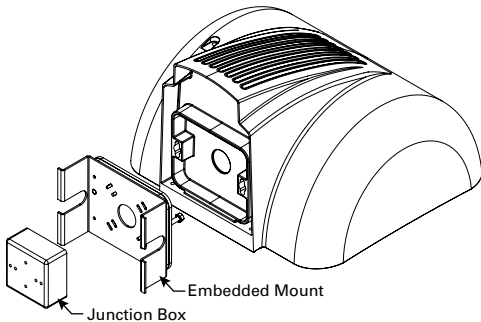

CONTROL OPTIONS

0-10V

This fixture is offered standard with 0-10V dimming driver(s). The DIM option provides 0-10V dimming wire leads for use with a lighting control panel or other control method.

Dimming Occupancy Sensor (MS/DIM-LXX and MS-LXX)

These sensors are factory installed in the luminaire housing. When the MS/DIM-LXX sensor option is selected, the occupancy sensor is connected to a dimming driver and the entire luminaire dims when there is no activity detected. When activity is detected, the luminaire returns to full light output. The MS/DIM sensor is factory preset to dim down to approximately 50 percent power with a time delay of five minutes. The MS-LXX sensor is factory preset to turn the luminaire off after five minutes of no activity. The MS/X-LXX is also preset for five minutes and only controls the specified number of light engines to maintain steady output from the remaining light engines.

These occupancy sensors includes an integral photocell that can be activated with the FSIR-100 accessory for "dusk-to-dawn" control or daylight harvesting - the factory preset is OFF. The FSIR-100 is a wireless tool utilized for changing the dimming level, time delay, sensitivity and other parameters.

A variety of sensor lens are available to optimize the coverage pattern for mounting heights from 8'-40'.

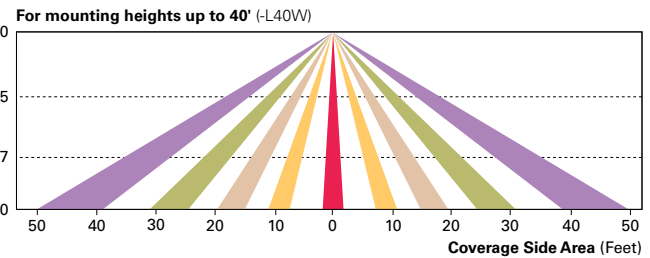
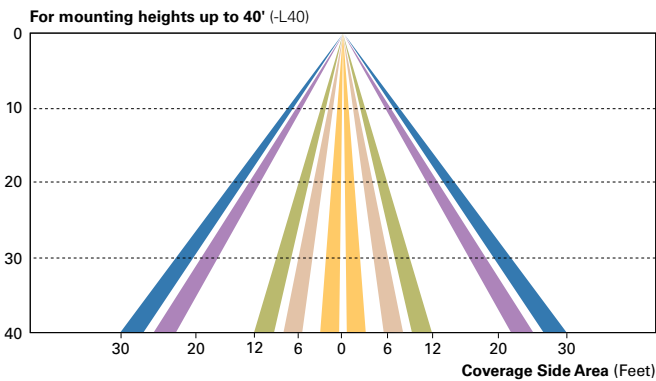
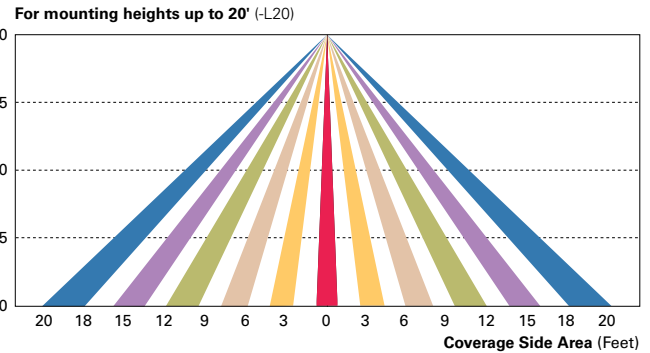
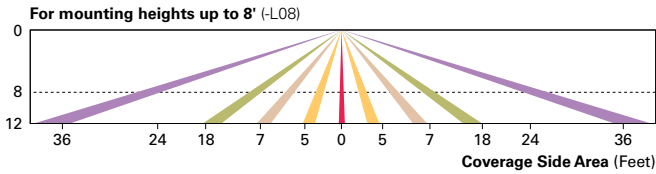

Enlighted Wireless Control and Monitoring System (LWR-LW and LWR-LN)

Enlighted system is a peer-to-peer wireless network of luminaire-integral sensors for any sized project. Each sensor is capable of motion and photo sensing, metering power consumption and wireless communication. The end-user can securely create and manage sensor profiles with browser-based management software. The software will automatically broadcast to the sensors via wireless gateways for zone-based and individual luminaire control. The Enlighted software provides smart building solutions by utilizing the sensor to provide easy-to-use dashboard and analytic capabilities such as improved energy savings, traffic flow analysis, building management software integration and more.

For additional details, refer to the Enlighted product guides.

