

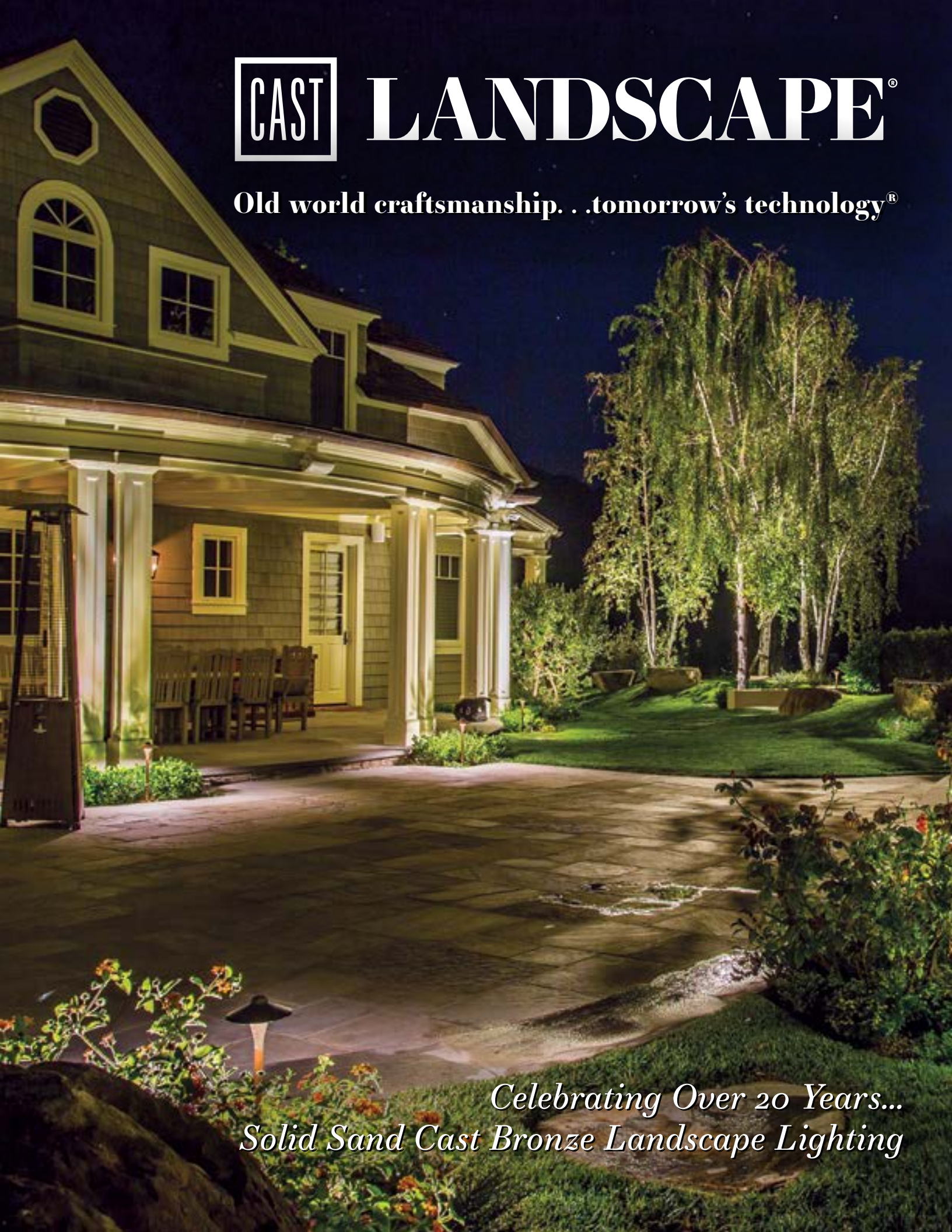

LANDSCAPE[®]

Old world craftsmanship. . .tomorrow's technology[®]



*Celebrating Over 20 Years...
Solid Sand Cast Bronze Landscape Lighting*

*“We use the best materials,
to produce the finest fixtures,
for customers who appreciate quality.”*

David Beausoleil, President



Solid Sand Cast Bronze Fixtures

CLASSIC SERIES

Solid bronze integrated and modular LED & incandescent fixtures that set the 'CAST Quality' standard.

CRAFTSMAN SERIES

Rock-solid integrated LED and NEW DROP-IN LED fixtures that meet the need for 'CAST Quality' at a lower price.



CAST AREA/PATH LIGHTS

These solid bronze path lights are suitable for lighting walkways, pathways, planting beds, and other areas. Compact with extreme durability, they feature sealed and protected LED components.

Classic Series



Classic-New Orleans
(CNO1CB)



Classic-Savannah
(CSA1CB, CSA1LED2)

LED Retrofit Modules:

Patent # 9, 146, 025



LED Path Light Retrofit Module (CALED2)



Turtle-Safe LED Path Light Retrofit Module (CALED2A)



LED Retrofit Module for Savannah Path Light & Wall Wash Light (CSWLED2)



Turtle-Safe LED Retrofit Module for Savannah Path Light & Wall Wash Light (CSWLED2A)

*For an outstanding glare-free light source, use these Retrofit Modules to Convert CAST Path Lights to LED

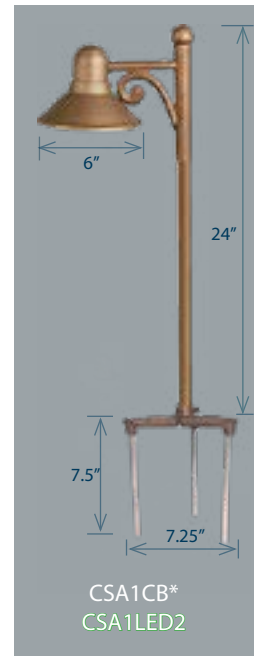

*Green Part Numbers Indicate Integrated LED

Fixture Specs:

	Voltage Range (AC/DC)	Total Lumens	Watts (cost to operate)	Volt Amps	CCT
CNO1CB w/CALED2	10-24	129	4.42	4.91	2800 +/-
CNO13CB w/CALED2	10-24	129	4.42	4.91	2800 +/-
CSA1LED2	10-24	200	4.42	4.91	2800 +/-

*CSA1CB fixture comes standard with a 2.5W S8 LED Lamp.

CAST AREA/PATH LIGHTS



Classic Series



Classic-Small
China Hat
(CCH1CB, CCH13CB)



Classic-Large
China Hat
(CCH2CB)



Classic-Large
Mushroom
(CMU2CB)



Classic-Small
Mushroom
(CMU1CB, CMU13CB)



Classic- Mini
China Hat
(CCH5CB, CCH5LED1)

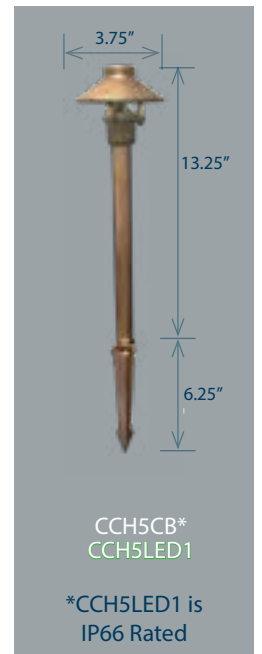
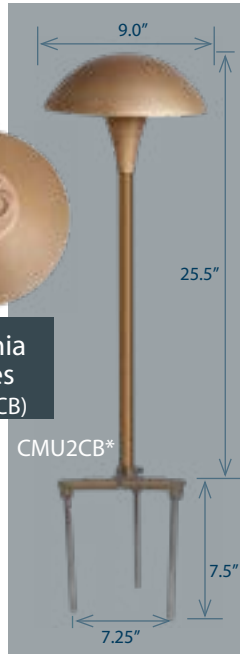
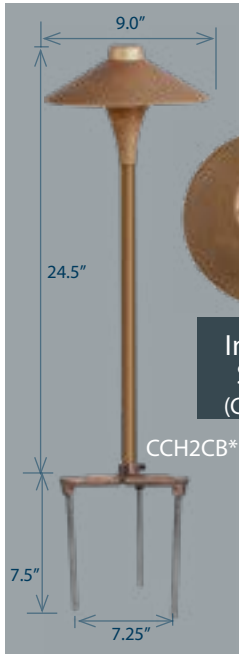

Insignia Series
(CISX2CB)

*CCH5LED1 is
IP66 Rated

Fixture Specs:

	Voltage Range (AC/DC)	Total Lumens	Watts (cost to operate)	Volt Amps	CCT
CCH1CB w/CALED2	10-24	82	4.42	4.91	2800 +/-
CCH13CB w/CALED2	10-24	82	4.42	4.91	2800 +/-
CCH2CB w/CALED2	10-22	116	4.42	4.91	2800 +/-
CISX2CB w/CALED2	10-24	116	4.42	4.91	2800 +/-
CMU2CB w/CALED2	10-24	131	4.42	4.91	2800 +/-
CMU1CB w/CALED2	10-24	104	4.42	4.91	2800 +/-
CMU13CB w/CALED2	10-24	104	4.42	4.91	2800 +/-
CCH5LED1	10-24	58	2.71	3.23	2800 +/-

*Classic Path Light Fixtures can use our CALED2 LED Module, 25W S8 Halogen Lamp, or a 2.5W S8 LED Lamp.

*CCH5CB fixture comes standard with 2.5W Bi-Pin LED Lamp.

CAST AREA/PATH LIGHTS

Craftsman Series

Available in Integrated LED or Drop-In LED!



Craftsman-Bronze Path/Area Light
(CCPL2B) Integrated LED
(CCPL2BL) Drop-In LED



Craftsman-China Hat Path/Area Light
(CCPLCHB) Integrated LED
(CCPLCHBL) Drop-In LED

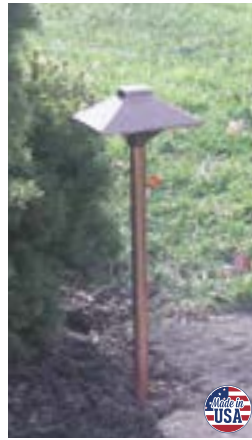

Craftsman-Borneo Path/Area Light
(CCPLBOB) Integrated LED
(CCPLBOBL) Drop-In LED



Craftsman-Cabana Path/Area Light
(CCPLCAB) Integrated LED
(CCPLCABL) Drop-In LED

INSIGNIA SERIES

Custom logo
bronze embossed
light fixtures.



Classic-Insignia Path/Area Light
(CISX2CB)

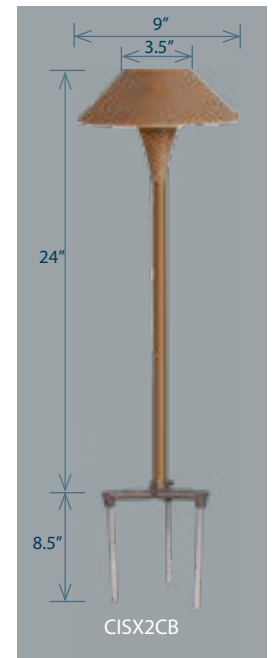
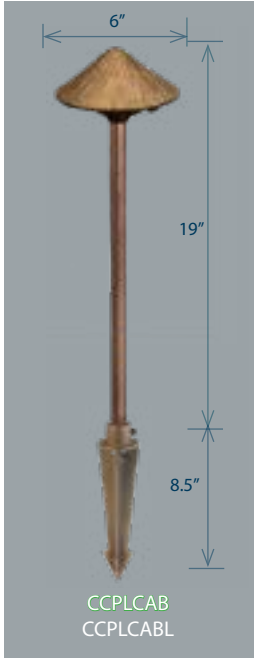
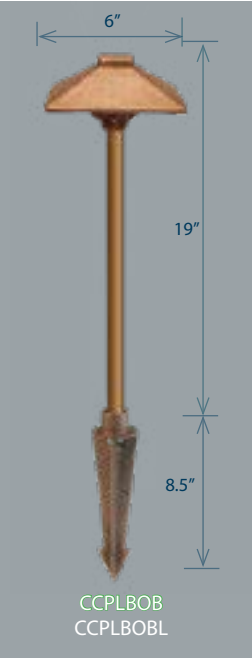
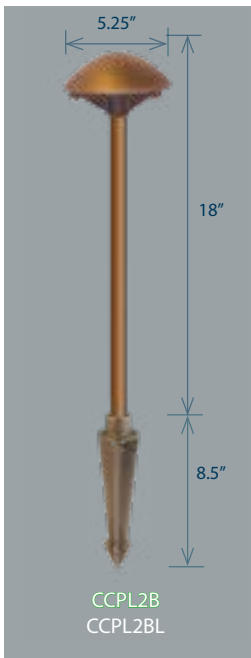

Fixture Specs:

Fixture Part Number	Voltage Range (AC/DC)	Total Lumens	Watts (cost to operate)	Volt Amps	CCT
CCPL2B, CCPLCHB, CCPLBOB, CCPLCAB Integrated LED	10-24	114	4.22	4.74	2800 +/-
CCPL2BL, CCPLCHBL, CCPLBOBL, CCPLCABL Drop-In LED included	10-20	250	2.5	3.0	2800 +/-
CISX2CB w/CALED2	10-24	116	4.42	4.91	2800 +/-



Drop-In LED Fixture includes
lamp SLBP250L

*Green Part Numbers indicate Integrated LED and are IP66 Rated.

www.cast-lighting.com

800-914-2278

CUSTOM FIXTURE CREATIONS

Design and build your own fixtures for any application.



EZ-Riser™ Set-In-Stake® Custom Riser System

The Coupling, Elbow, and Tee allow you to create customized stem and mounting configurations. *The Copper Piping is available in sizes up to 48" and can be cut to size in the field.



The Possibilities are Endless!

Two Tree Lights with the (CCPT1) Tee, 2" (CCPSTEM2), and the tree mounting canopy (XCBPTMC1).



Mini China Hat Sconce (CCH5LED1SC)
Depth 6" from wall,
Height 8" from bottom of base.

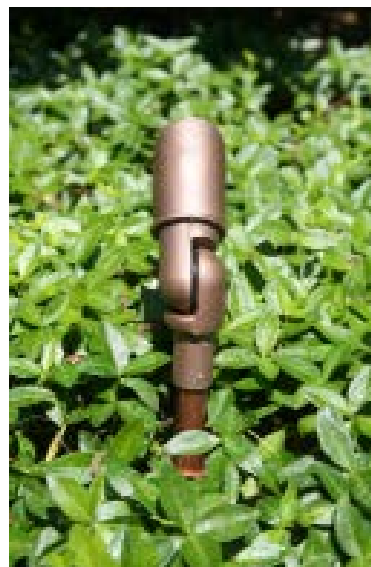

Craftsman Spot/Wash Light with 4" (CCPSTEM4) & (CCPC1) Coupling.



Two Craftsman Spot/Wash Lights with 6" (CCPSTEM6), (CCPT1) Tee and Talon Stake (CTSL1).

CAST DIRECTIONAL LIGHTS

Classic Series

These rugged directional lights can be used to uplight plant material, structures, and architectural features. A wide range of lamp wattages and beam angles allow for maximum design flexibility.



Photo courtesy of Steve Middleton, Treasure Coast Landscape Lighting, Hobe Sound, FL

The fixture that started it all, the CBL1CB, OVER 20 YEARS IN THE GROUND AND STILL GOING STRONG!



Bullet Lights
(CBL1CB & CBLED141)

LED Replaceable Optics and Lamps:



COLOR CODED!
MR16 DROP-INS
(for CBL1CB)
See Pg. 18 for
options

COMING IN 2022!

NEW



CBL1CB-US



Replaceable
Optics
(for CBLED141)
12°, 21°, 41°



*Green Part Numbers indicate Integrated LED

Fixture Specs:

	Voltage Range (AC/DC)	Total Lumens	Watts (cost to operate)	Volt Amps	CCT	Halogen Equivalent (Watts)	No-Ox Lead Wire Length
CBLED141	10-24	328 High/ 269 Low	9.25 High/ 5.86 Low	9.84 High/ 6.3 Low	2800 +/-	50 High/ 35 Low	25 ft.

*CBL1CB & CBAL1CB, lamp is not included. Fixtures require an MR-16 Bi-Pin Lamp (LED or Halogen) of your selection.

*CBL5CB, lamp is not included. Fixture requires an MR-11 Bi-Pin Lamp (LED or Halogen) of your selection.

CAST DIRECTIONAL LIGHTS

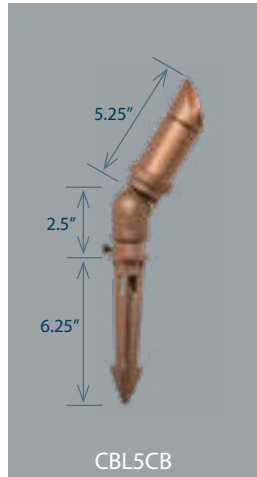

MR-11 Bullet Light (CBL5CB)



MR-16 Area Bullet Light (CBAL1CB)



* The CBAL1CB works best with our MR16 SLMR161XXW27, 80° beam for Path Lighting, see pg. 18



Note: The fixtures on pg 8-9 come with a 25ft Lead Wire.



CAST DIRECTIONAL LIGHTS



Craftsman-Bronze Spot/Wash Lights



Craftsman-Bronze Quick-Change Modules



Copper Niche Light (CNL1CB)

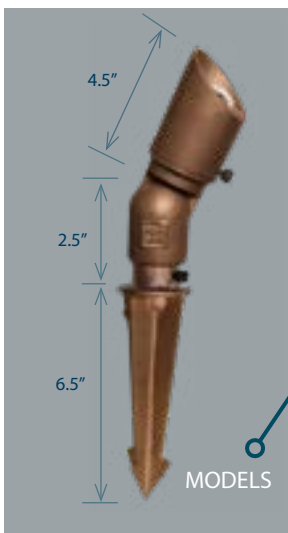

*All Craftsman fixtures are LED

Craftsman-Bronze Spot/Wash Lights	
Model	Lumens (Lm) /Beam Angle
CCSL10536B	89/36°
CCSL18336B	153/36°
CCSL18354B	153/54°
CCSL25036B	229/36°
CCSL25054B	229/54°
CCW105B	49/80°
CCW270B	164/80°

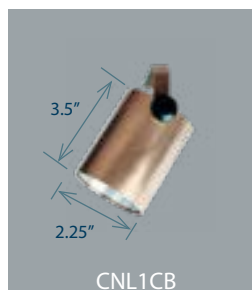

CNL1CB

2.5W T-5 LED Lamp included with Niche Light.

*All Craftsman Series Fixtures are IP66 Rated

*Green Part Numbers indicate Integrated LED

Fixture Specs:

	Voltage Range (AC/DC)	Total Lumens	Watts (cost to operate)	Volt Amps	CCT	Halogen Equivalent (Watts)	No-Ox Lead Wire Length
CCSL10536B	10-24	89	2.82	3.2	2800 +/-	10	5 ft.
CCSL18336B	10-24	153	2.68	3.08	2800 +/-	20	5 ft.
CCSL18354B	10-24	153	2.68	3.08	2800 +/-	20	5 ft.
CCSL25036B	10-24	229	4.3	5.24	2800 +/-	35	5 ft.
CCSL25054B	10-24	229	4.3	5.24	2800 +/-	35	5 ft.
CCW105B	10-24	49	2.82	3.2	2800 +/-	10	5 ft.
CCW270B	10-24	164	4.33	4.81	2800 +/-	20	5 ft.

CAST TREE LIGHTS



These tree light directional options are suitable for mounting in trees or on structures to provide a natural downlighting or moonlighting effect.



CCTL1C MR16 DROP-IN & CTLED141 INTEGRATED
Made with sand cast solid bronze base



CTLED141 INTEGRATED

CCTL1C*
MR16 DROP-IN (not included)
(Works best with MR16 Lamp #SLMR164XW27)

CCTL2C

Made with die cast brass, oil-rubbed bronze finish base

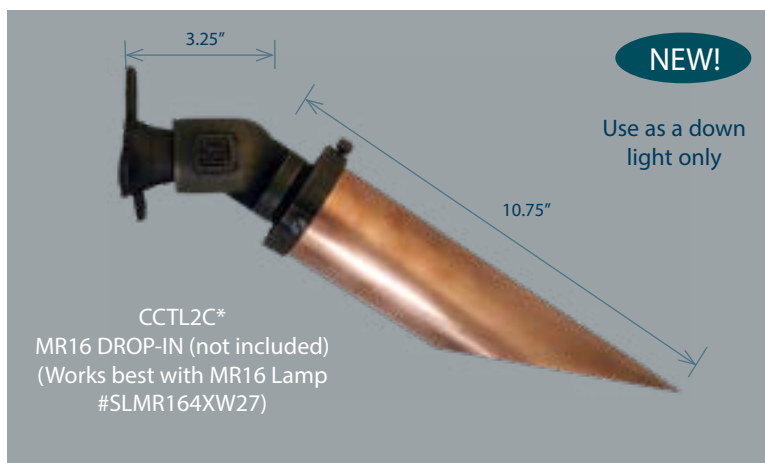

NEW!

Use as a down light only

CCTL2C*
MR16 DROP-IN (not included)
(Works best with MR16 Lamp #SLMR164XW27)

LED Replaceable Optics and Lamps:



Replaceable Optics
(for CTLED141)
12°, 21°, 41°



COLOR CODED!
MR16 Drop-Ins
*See Pg. 18

*CTREEH1 Mounting Hardware (incl. with all tree lights)

*Green Part Numbers indicate Integrated LED

Fixture Specs:

	Voltage Range (AC/DC)	Total Lumens	Watts (cost to operate)	Volt Amps	CCT	Halogen Equivalent (Watts)	No-Ox Wire Length
CTLED141	10-24	157 Low/ 269 High	4.1 Low/ 5.86 High	4.41 Low/ 6.3 High	2800 +/-	20 Low/35 High	35 ft.

*CCTL1C and CCTL2C lamp not included. Fixture requires an MR-16 Bi-Pin lamp of your choice (see pg. 18).

CAST DECK/WALL/WASH LIGHTS

Suitable for downlighting when mounted on retaining walls, structure surfaces, posts, signs, walls, or plant material, these lights provide a wide, bright, and diffused illumination.



Craftsman-Bronze Deck Lights
(CCDL1B, CCDL1BFG, CCDL1BA)



Classic Deck Lights
(CDL1CB, CDL1LED1, CDL1LED1A)



Savannah Deck Light
(CDL2CB)



Classic Wall Wash
(CWW1CB, CWW1LED2)

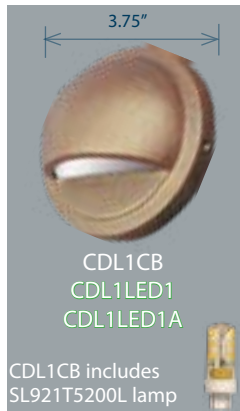

CCDL1BA & CDL1LED1A are Turtle-Safe fixtures.
See pg 19 for details.

*All Craftsman Series Fixtures are IP66 Rated

*Green Part Numbers indicate Integrated LED

Fixture Specs:

	Voltage Range (AC/DC)	Total Lumens	Watts (cost to operate)	Volt Amps	CCT	No-Ox Wire Length
CDL1LED1	10-24	49	2.82	3.20	2800 +/-	25 ft.
CCDL1B	10-24	89	2.88	3.27	2800 +/-	5 ft.
CWW1LED2	10-24	148	4.33	4.81	2800 +/-	25 ft.

*CDL1CB includes 2.5W T5 LED Lamp #SL921T5200L.

*CDL2CB includes 2.5W T5 LED Lamp #SL921T5200L.

*CWW1CB includes 2.5W S8 LED Lamp #SL3156250L.

*CEWL5CB & CEWL6CB includes 2.5W T5 LED Lamp #SL921T5200L.

*CCDL1BFG comes with frosted lens.

CAST DECK/WALL/WASH LIGHTS



Wall Wash
(CWL6LED1)
See Mounting Kits pg 16

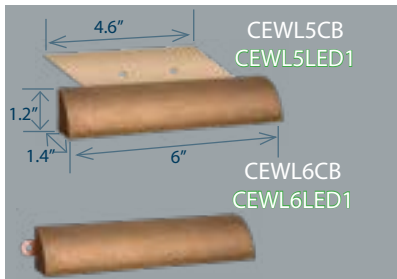
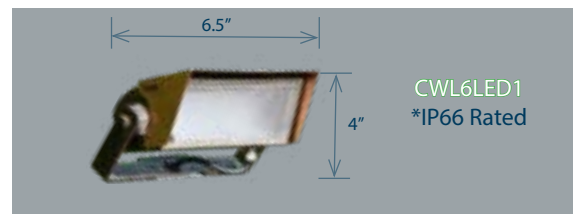

Engineered Wall Light
(CEWL5CB, CEWL6CB)
Includes Drop-In
Lamp #SL921T5200L
(CEWL5LED1, CEWL6LED1)
Integrated LED

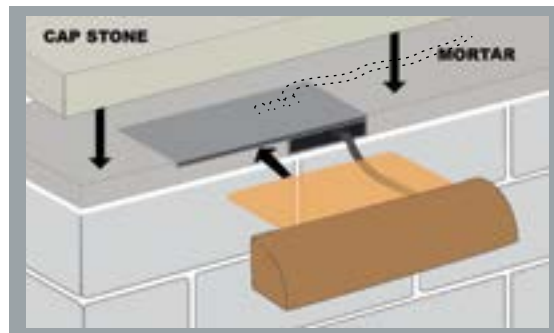

CAST Set-in-Stone® Wall Light Mounting System (for CEWL5 Series)

Includes Wall Light Mounting Module (CSIS) and Flexible Conduit (CSISC)

Installed during wall construction to provide fixture mounting locations and wiring conduit to be installed after the wall has been completed.

This system greatly simplifies the planning, installation, and maintenance of wall lights.

Set-in-Stone® Patent# 8, 627, 609, 8, 464, 492, D649, 695



Wall Light Mounting Module (CSIS)



Flexible Conduit (CSISC)

Fixture Specs:

	Voltage Range (AC/DC)	Total Lumens	Watts (cost to operate)	Volt Amps	CCT	No-Ox Wire Length
CWL6LED1	10-24	122	5.01	5.57	2800 +/-	25 ft.
CEWL5LED1	10-24	76	2.5	2.84	2800 +/-	25 ft.
CEWL6LED1	10-24	76	2.5	2.84	2800 +/-	25 ft.

CAST WELL/GROUND LIGHTS

These rugged well and ground lights are great for uplighting/wash lighting landscapes, shrubs, trees, and architectural features and are extremely effective washing low and wide plant material.

Craftsman Ground Lights



Craftsman-Bronze Ground Lights

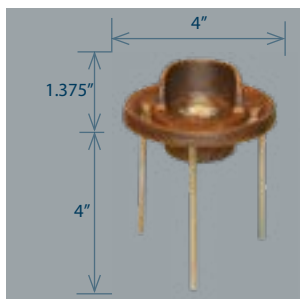

Craftsman-Bronze Ground Lights	
Model	Lumens (Lm) /Beam Angle
CCGL18336B	153/36°
CCGL25036B	229/36°
CCGL105WB	49/80°
CCGL270WB	164/80°

Classic Well Lights



Well Light (CWFL Series)

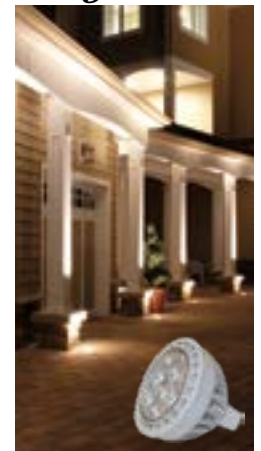

MR-16 Drop-In Well Light (CWLMR16 Series)



*CWLGM2CB comes with CWLMR16G, if you prefer CWLG1CB please specify.

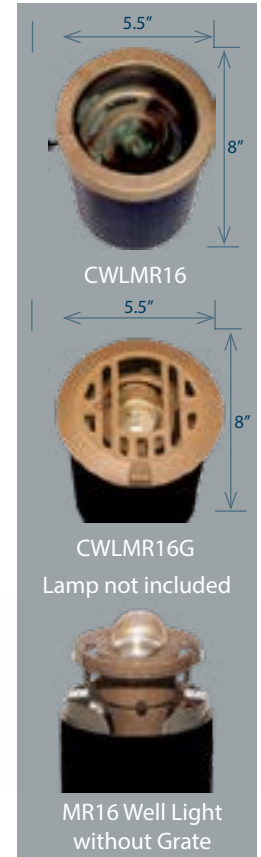

*All Craftsman ground light fixtures are Integrated LED

Fixture Specs:

	Voltage Range (AC/DC)	Total Lumens	Watts (cost to operate)	Volt Amps	CCT	No-Ox Wire Length	Halogen Equivalent (Watts)
CCGL18336B	10-24	153	2.69	3.06	2800 +/-	5 ft.	20
CCGL25036B	10-24	229	4.3	5.24	2800 +/-	5 ft.	35
CCGL105WB	10-24	49	2.82	3.20	2800 +/-	5 ft.	10
CCGL270WB	10-24	164	4.33	4.81	2800 +/-	5 ft.	20

*CWLMR16 & CWLMR16G Lamp not included. Fixtures require an MR-16 Bi-Pin Lamp (LED or Halogen) of your selection.

CAST TRANSFORMERS & NO-OX[®] WIRE



Transformers



Journeymen[®] Series

Master Series

Transformer Accessories



Photocells (CTPC) (CTRPC)
The quick-connect photocell plugs into the transformer to switch on the power at dusk. It is typically used in conjunction with a CAST Time Clock.



CAST Plug In Time Clock (CTTC)
This manual time clock plugs into the transformer time receptacle and is easy to program.



CAST Digital Time Clock (CTDTC)
This time clock works with all CAST transformers. It gives you more setting and options compared to the Manual Time Clock.

CAST Lighting Multi-Tap Toroidal Transformers				
Model #	Volt-Amps	Voltage Taps	Enclosure	Features
Journeymen Series [*]				
CJT75SSMTTC	75	12, 15, & 20	Stainless Steel	Time clock included
CJT150SSMT	150	12-15		Secondary magnetic circuit breakers can accommodate up to 10 fixtures
CJ300SSMT	300	12-15		
CJ600SSMT	600	12-15		
CJ900SSMT	900	12-15		
Master Series				
CM1200SSMT	1200	12-18	Stainless Steel	Primary Breaker and Extra Common
CM900SSMT	900	12-18		

*220/240V export models available for CJ300, CJ600, & 24 Volt CPT Series models.
Volt-Amps equivalent to watts for incandescent.

No-Ox[®] Tin-Coated Marine Grade Wire

- Tin-coated for corrosion resistance
- Direct burial, stranded, for low voltage lighting
- Descending footage markings on wire
- 2-Conductor 500 ft. put up
 - #8-2 – CLW82500
 - #10-2 – CLW102500
 - #12-2 – CLW122500
 - #14-2 – CLW142500 (Grey)
 - #16-2 – CLW162500
- 2-Conductor 250 ft. put up
 - #10-2 – CLW102250
 - #12-2 – CLW122250



Why Tin-Coated Marine-Grade Wire?

CAST Lighting abandoned the use of all copper wire and here is why:

- Tin protects the conductor in the harsh outdoor environment.
- Tin oxides maintain their conductivity.
- Soldering provides the most secure, corrosion resistant splice points. Tin solder is the most preferred type, therefore tin-coated wire is the best choice for a seamless connection.
- Tin-Coated Marine-Grade wire is UL Listed.
- For the most durable field wiring choose CAST No-Ox[®] Low Voltage Wire

CAST ACCESSORIES

Use these options, tools, and accessories to complete your landscape lighting job.

Mounting Options:

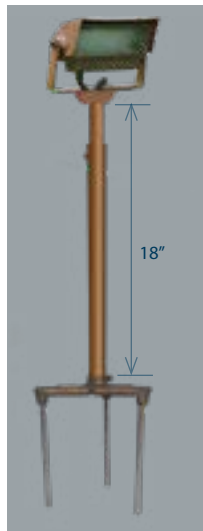

CWL9KIT



CWL9EXKIT

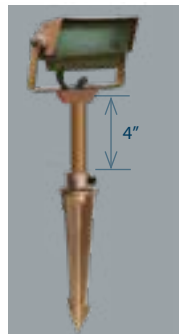

CWL8KIT



CWL7KIT



Large Talon Stake®
(CTSL1CB)
(Bronze)

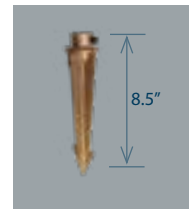

Standard Stake
(CMS1CB)
(Bronze)

CWL*KITS
include mount, stem, and flange -
for CWL6LED1 and CIWL6.



Heavy Duty
Mounting Stake
(CHMS1CB)



CWTRS

XCBPS

CWTRS

Fixture Extensions

Fixed Extensions for
Directional Lights:
Use CWTRS Series

Telescopic
Extensions for
Directional Lights:
Use CBTRS Series

Fixed Extensions
for Path Lights:
Use XCBPS Series

Telescopic
Extensions for
Path Lights:
Use CWTRS Series

Extension available up to 48".
Mounts not included.



Set-In-Stake
Transition Adaptor
(XCBPTA2)



Tree Light
Transition Adaptor
(XCBPTLTA)



Tree Light
Mounting Canopy
(XCBPTMC1)



Floor Mount
Stem Assembly
(CMFSA)

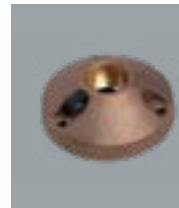

Mounting Canopy
(CFM1CBS)



Tree Light
Mounting Hardware
(CTREEH1)

* All CAST fixtures have threadless studs (Set-in-Stake®) - though some have threaded stems (at top).
All stakes and canopies are threadless (except CHMS1CB): some stem extensions have threaded tops.
Threaded versions of most of these products are available - please call with questions.

Tools:



S8 Voltage
Testing Tool
(CTESTS8)



MR-16 Voltage
Testing Tool
(CTESTMR16)



8-Bit Screwdriver
(C4WAY)



Wire Spinner
Dispenser
(CSPIN)



Ideal Automatic
Wire Stripper
(CASTRIP1)

CAST ACCESSORIES



Installation Parts:



Spider Splice®
Box Assembly
(CSS1)



Distributor
Parts Kit
(CPK1)



Contractor
Parts Kit
(CPK2)



Wire Repair
Splice Kits
(CLWSK)

*See our Website for detailed contents of Parts Kits and Wire Repair Splice Kits

Crimp Connections and Heat Shrink

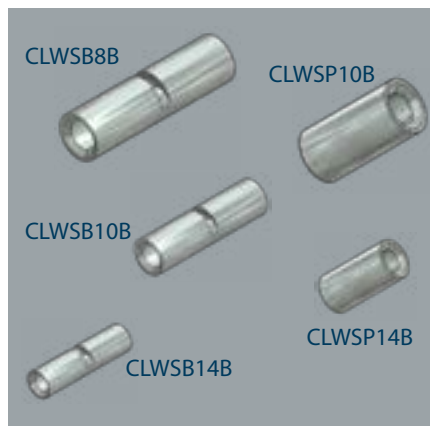

BULK Seamless Non-Insulated
Butt Crimp Connections
(CLWS***)

Wire Crimp Connections come in a variety of sizes and two different styles (Butt Splice Crimp & Parallel Crimp). You can make wire crimp connections for #18, #16, #14, #12, & #10 No-Ox® Wire. They come in bags of 250 pcs.

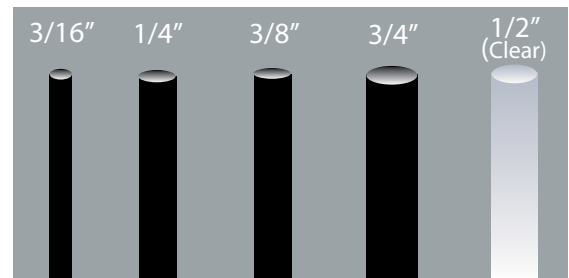

BULK Heat Shrink
with Internal Sealant
(CHS***)

The new heat shrink comes in a variety of sizes (black 3/16", 1/4", 3/8", and 3/4" and NEW 1/2" clear in 2 ft. sections) at fantastic BULK pricing and packaging.

Mini LED Lamps:

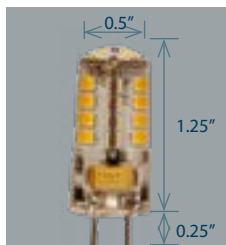

SLBP250L
GY6.35 Bi-Pin Base LED;
2.5 Watts, 9 - 20 Volt
operating range; 250
Lumen, Color Temp.
2750°K; IP67 Rated,
25,000 Hrs.

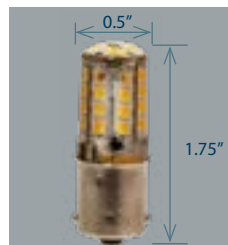

SLSCB250L
Single Contact Bayonet
LED; 2.5 Watts, 9 - 20
Volt operating range;
250 Lumen, Color Temp.
2750°K; IP67 Rated,
25,000 Hrs.

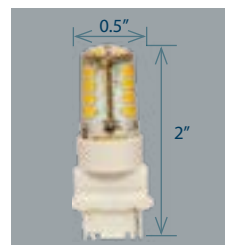

SL3156250L
3156 S8 Wedge Base
LED; 2.5 Watts, 9 - 20
Volt operating range;
250 Lumen, Color Temp.
2750°K; IP67 Rated,
25,000 Hrs.

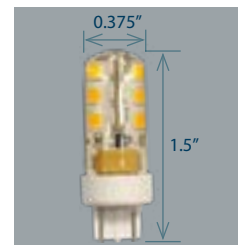

SL921T5200L
921 T5 Wedge Base LED;
2.5 Watts, 9 - 15 Volt;
operating range; 200
Lumen, Color Temp.
2750°K; IP67 Rated,
25,000 Hrs.

LED MR-16 LAMPS

Color-Coded & Engraved for Easy Identification!

Available in 2700K and 3000K

 Lamp Code	Beam from Fixture		Halogen Equiv.	Lamp Body Color Code	Voltage Input	Color Temp. CCT/CRI	Amps	Power Factor	Volt Amp (to size)	Factory Lumen	Lumen Output Enclosed Fixture	Rated Hrs.
SLMR166XXW27	XX-Wide	80°	75 Watt	WHITE 6 Watt	10-24 VAC	2700°K/ 83 CRI	0.706	0.717	8.49	720	213	50,000
SLMR166XW27	X-Wide	55°									440	
SLMR166W27	Wide	40°									527	
SLMR166M27	Medium	30°									575	
SLMR166N27	Narrow	20°									559	
SLMR166XW30	X-Wide	55°				3000°K/ 83 CRI	0.762	0.681	9.16		534	
SLMR166W30	Wide	40°				0.745	0.677	9.0	557			
SLMR165XXW27	XX-Wide	80°	50 Watt	BLACK 5 Watt	10-24 VAC	2700°K/ 83 CRI	0.542	0.7	6.56	540	175	50,000
SLMR165XW27	X-Wide	55°									392	
SLMR165W27	Wide	40°									419	
SLMR165M27	Medium	30°									421	
SLMR165N27	Narrow	20°									381	
SLMR165XW30	X-Wide	55°				3000°K/ 83 CRI	0.671	0.658	7.45		426	
SLMR165W30	Wide	40°				0.608	0.658	7.34	456			
SLMR164XXW27	XX-Wide	80°	35 Watt	BLUE 4 Watt	10-24 VAC	2700°K/ 83 CRI	0.387	0.691	4.67	390	199	50,000
SLMR164XW27	X-Wide	55°									299	
SLMR164W27	Wide	40°									304	
SLMR164M27	Medium	30°									305	
SLMR164N27	Narrow	20°									267	
SLMR164XW30	X-Wide	55°				3000°K/ 83 CRI	0.435	0.637	6.0		310	
SLMR164W30	Wide	40°				0.435	0.65	5.26	322			
SLMR162XXW27	XX-Wide	80°	20 Watt	GREEN 2 Watt	10-24 VAC	2700°K/ 83 CRI	0.236	0.664	2.83	300	128	50,000
SLMR162XW27	X-Wide	55°									193	
SLMR162W27	Wide	40°									189	
SLMR162M27	Medium	30°									193	
SLMR162N27	Narrow	20°									167	
SLMR162XW30	X-Wide	55°				3000°K/ 83 CRI	0.249	0.64	3.0		197	
SLMR162W30	Wide	40°				0.23	0.66	3.0	196			
SLMR161XXW27	XX-Wide	80°	10 Watt	RED 1 Watt	10-24 VAC	2700°K/ 83 CRI	0.139	0.63	1.69	240	74	50,000
SLMR161XW27	X-Wide	55°									106	
SLMR161W27	Wide	40°									104	

Shaded Information = NEW 3000K Color Temp Lamps

Lamp Packaging: 1 Lamp Per Box, 10 Lamps Per Pack, 10 Packs Per Master Carton. Product covered by PATENT #10,876,706

CAST PATINA & TURTLE-SAFE



The Patina Process:

CAST bronze and copper fixtures start with a metallic sheen, then change to an old-penny brown, then finally to a "Statue of Liberty" patina.

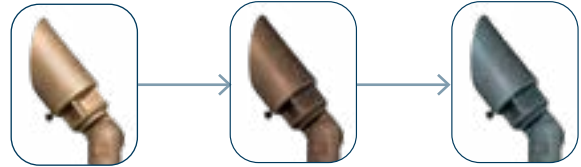

Bronze is a Living Finish



CAST Turtle-Safe:



The Florida Fish and Wildlife Conservation Committee, approved specific LEDs from CAST Lighting as being Turtle-Safe. All species of Sea Turtles are recognized as either endangered or threatened. The Federal Endangered Species Act of 1973 protects them. Artificial lighting used for beach front properties may interfere with turtle egg-laying and hatching. In order to have our LEDs comply we must abide by the "Wildlife Lighting Criteria" which includes mounting restrictions, shielded bulbs and lamps, and long wavelength of bulbs. For more information, check out our articles at www.cast-lighting.com

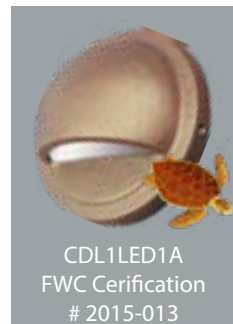

Old world craftsmanship. . .tomorrow's technology[®]

CAST LANDSCAPE[®]

www.cast-lighting.com

Copyright 2022, CAST Lighting, Hawthorne, NJ 07506. Patents Pending. All rights reserved.
Images and text may not be reproduced in any form without the written permission of CAST Lighting, LLC.

Back cover photo courtesy of James Burkholder, YardWorks, Inc., Brockway, PA @yard_works | www.YardWorksCo.com