

barbicanlighting
Zepher

This elegant, elongated, ellipse is available in 6 sizes and 3 fin configurations, with or without lighting options. Available in 6 sizes and 3 fin configurations, with or without lighting options. The taper on the bottom of the fins is 30 degrees. Acoustic Fixtures are an excellent way to decrease ambient noise in your space. High design and function make these fixtures a beautiful and unique way to establish your own Quietude..

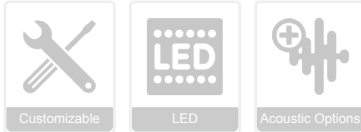

Please find an overall listing of all product options. Barbican specializes in producing products on a per request basis. Please feel free to use our online builder to determine conditional options, or confer with your lighting rep, or reach out to sales@barbican.ca for more information.



Type		# Fins		Diameter		Acoustic Material		Mounting	
L	Lit	4F	4	10D	10" (lit-HPC 4"D 12"H)	AR-CRT	Carrot	ACW	Aircraft Cable WHITE Power Cord
	U	Unlit	8F	8	18D	18" (lit-HPC 6"D 24"H)	AR-CNF		
		12F	12	28D	28" (lit-HPC 8"D 36"H)	AR-EBY	Ebony	ACB	Aircraft Cable BLACK Power Cord
				36D	36" (lit-HPC 10"D 48"H)	AR-HTH	Heather	SM	Stem Mount
				45D	45" (lit-HPC 10"D 60"H)	AR-LIN	Linen		
				55D	55" (lit-HPC 10"D 72"H)	AR-MAR	Marble		
						AR-MOS	Moss		
						AR-PRT	Peridot		
						AR-RBY	Ruby		
						AR-SFN	Saffron		
						AR-SND	Sand		
						AR-SGR	Sangria		
						AR-SEP	Sepia		
						AR-SLT	Slate		
						AR-UMR	Ultramarine		

Finish (Canopies, Stems)		Source		Voltage		Temperature	
WHT	White	800LM/LF	800LM/LF (8W/LF)	120/277V	120/277 Volts	2700K	2700 °K
BLK	Black	1200LM/LF	1200LM/LF (12W/LF)			3000K	3000 °K
BA	Brushed Aluminum					3500K	3500 °K
RAL	RAL (North American)					4000K	4000 °K
						CT	Colour Tuning 2700-6500 °K

Colour Rendering Index		Dimming Drivers	
90CRI	90 CRI	DB(0-10V10)	0-10V (10%)
		DB(0-10V05)	0-10V (5%)
		DB(0-10V01)	0-10V (1%)

Materials Choose from our large materials collection using our online product builder.

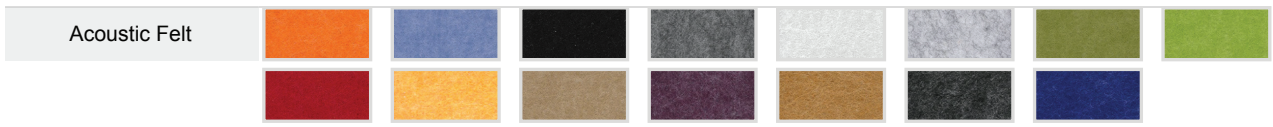

Please visit our website to view our full material galleries

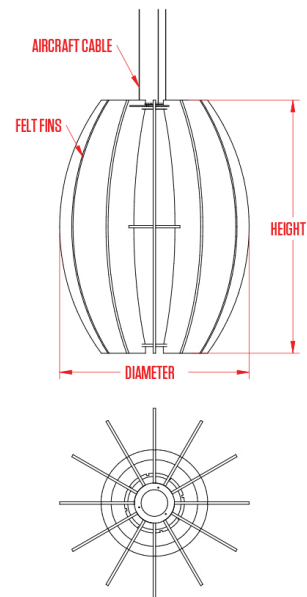
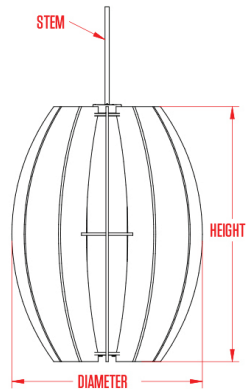
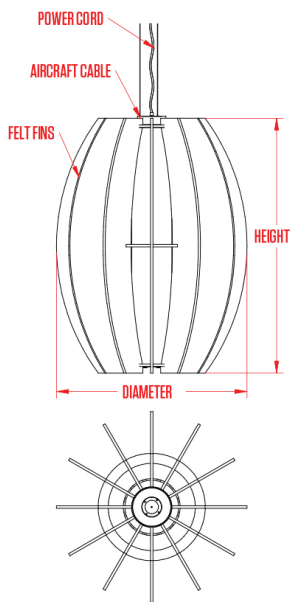

	canada: 479 central avenue fort erie, ontario L2A 3T9 usa: 266 elmwood avenue, unit 388 buffalo, new york 14222 www.barbican.ca 800 663 5781 info@barbican.ca
	PRODUCT CODE: AR-100L-F04
	PRODUCT NAME: ZEPHER CONTACT: sales@barbican.ca

	canada: 479 central avenue fort erie, ontario L2A 3T9 usa: 266 elmwood avenue, unit 388 buffalo, new york 14222 www.barbican.ca 800 663 5781 info@barbican.ca
	PRODUCT CODE: AR-100L-F04
	PRODUCT NAME: ZEPHER CONTACT: sales@barbican.ca

ACOUSTIC FELT Colour Samples



Carrot
AR-CRT



Cornflower
AR-CNF



Ebony
AR-EBY

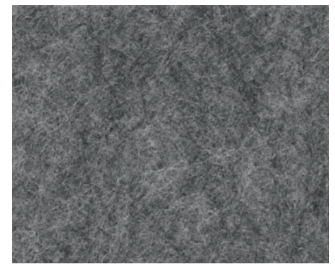

Heather
AR-HTH



Linen
AR-LIN

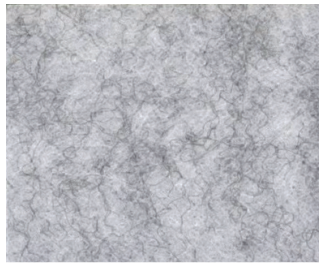

Marble
AR-MAR



Moss
AR-MOS



Peridot
AR-PRT



Ruby
AR-RBY

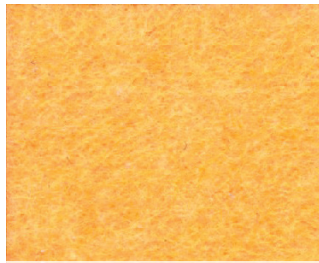

Saffron
AR-SFN



Sand
AR-SND

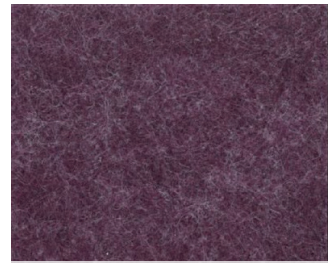

Sangria
AR-SGR



Sepia
AR-SEP

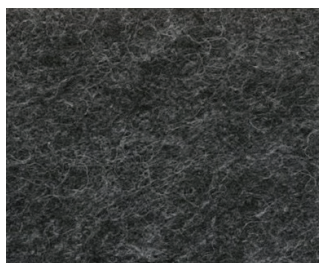

Slate
AR-SLT

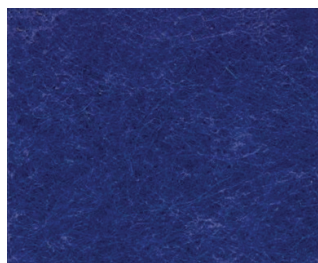

Ultramarine
AR-UMR