

HPC3

T-WELD

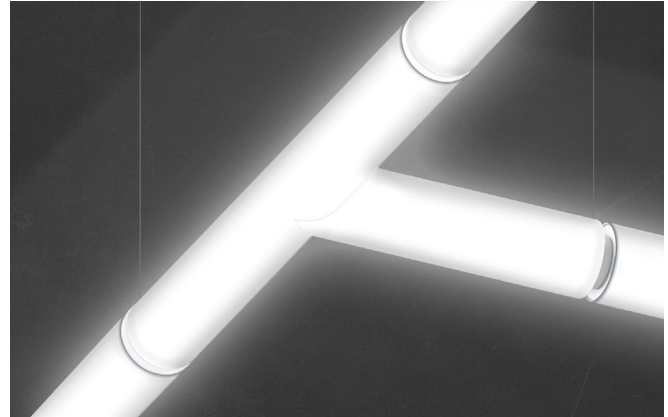

Low-glare, infinitely customizable, continuous, omni-directional, architectural light source. Perfectly designed for spaces requiring diffused light that provides soft and even illumination on walls, ceilings, and work surfaces.

The modular HPC3 system provides many configurations to fit any space you have. Our curved and welded corners will ensure your space feels considered and beautiful, while our industry leading Quick Ship program can ensure you have your light fixtures on-site in-time.

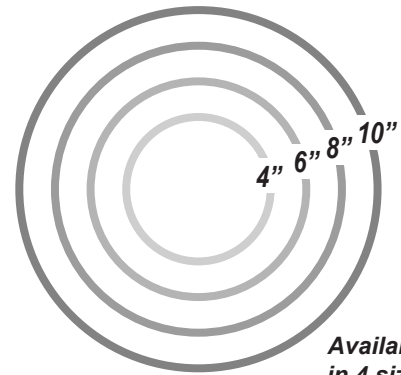

Available in 4 sizes

AVAILABLE CONFIGURATIONS



Straight



Curved Bends



X-Welds



L-Welds



Vertical Columns

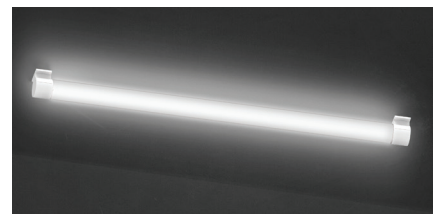

Surface Mount

AVAILABLE FINISH OPTIONS

Metal

Acoustic



SPECIFICATION (1/2)

10 day quick-ship (see following pages for quick-ship information, limitations and requirements)

Fixture	Diameter	Length 1	Length 2	Mounting	Driver Location	Voltage
22-T	<input type="text"/>	<input type="text"/>	<input type="text"/>	<input type="text"/>	<input type="text"/>	UNV
22-T HPC3	4D 4" 6D 6" 8D 8" 10D 10"	48L 48" CUSL Custom length	24L2 24" CUSL Custom length	ACM Aircraft Cable SFM Surface Mount* <i>Consult factory for surface mounting</i> <i>* Requires "RD" Remote Driver option</i>	SCDL Surface Canopy RDDL Remote Driver ADDL ACT Remote Driver RCDL Recessed Canopy	UNV 120/277 Volts <i>Consult factory for other voltages</i>

Canopy Finish	End Cap Finish	Power Cable Finish	Source
<input type="text"/>	<input type="text"/>	<input type="text"/>	<input type="text"/>
WCF White BCF Black SCF Silver RAL Custom <i>RAL North America; Consult factory</i>	WEC White BEC Black SEC Silver RAL Custom <i>RAL North America; Consult factory</i>	WPC White BPC Black XPC None <i>for use with "SM" Surface Mount only</i>	0800LM Standard 800 lm/ft (8W/ft) <i>standard for 4"</i> 1200LM Standard 1200 lm/ft (12W/ft) <i>standard for 6"</i> CUSLM Custom Lumen Output* <i>600lm/ft - 4800lm/ft; Consult factory for outputs outside of this range</i> <i>* Maximum output varies by diameter</i> <i>4" - 1600 lm/ft (16W/ft)</i> <i>6" - 1600 lm/ft (16W/ft)</i>

Color Temperature	Color Rendering	Dimming Driver	Options Continued on Next Page
<input type="text"/>	90CRI	<input type="text"/>	<input type="text"/>
2700K 2700K 3000K 3000K 3500K 3500K 4000K 4000K 5000K 5000K	2765K Tunable White* <i>2700K - 6500K</i> RGB30 RGBW* <i>RGB + 3000K</i> 3000FS Full Spectrum <i>3000K</i> 3500FS Full Spectrum <i>3500K</i> CUSK Custom CT <i>2400K - 6000K;</i> <i>* Only available in 6", 8", and 10"</i> <i>* Consult factory for CT options in this column</i> <i>Full spectrum .95 reduced output contact factory</i>	90CRI 90+ CRI	S010V10 Standard 0-10V, 10% S010V01 Standard 0-10V, 1% E010V01 eldoLED 0-10V, 1% EDALI01 eldoLED DALI, 0.1% EDMX01 eldoLED DMX, 0.1% LECO01 Lutron EcoSense, 1% MOLPOE Molex POE Node CUSDD Other Driver Options <i>Consult factory for availability of other driver options</i>

SPECIFICATION (2/2)

 **10 day quick-ship** (see following pages for quick-ship information, limitations and requirements)

Modular Configuration*

Acoustics

NCMC No Configuration
CUSMC Custom Configuration
Drawing Required. Consult factory

* See following pages for corners and configuration options

NOAC No Acoustics
ADAC Add Acoustics
Consult factory for availability

WRITTEN SPECIFICATIONS

LED System

- LED Circuitry is applied to minimum 0.0625" thick aluminum extruded cores for excellent heat management. Fixture uses **Four-Core and Six-Core Technology** to provide even illumination in all directions.
- LEDs are 90+CRI, 3 SDCM.
- 4 foot fixture performance at 3000K 90CRI, 6896lms, 61.44 Watts, 112 LPW Delivered

Construction

- Diffuser: 0.120" Extruded PETG (polyethylene terephthalate glycol-modified); which is a variant of PET used in water bottles everywhere. Designed to be used in environments where high levels of disinfectant products are used. It is also has a much higher impact resistance than Acrylic and is available up to 20 feet in single lengths.
 - Barbican uses a proprietary diffusion formula PETG which in conjunction with the LED system provides excellent efficiencies of up to 115 lumens per watt at 3000K 90+ CRI.
- Metal construction to be aluminum minimum 0.0625" thickness. Fasteners are to be stainless steel.
- Cable grippers are nickel plated solid brass and stainless steel. Cables are 1/16" stainless steel.
- Canopies and driver housings are minimum 0.0625" aluminum.

Mounting

- Surface cable mounts are nickel plated solid brass and are supplied with escutcheon plates for through surface power cables. Power cables are low voltage from the canopy/remote mounted drivers.
- Drivers:** All drivers are mounted remote from the fixture. Standard drivers include 0-10V 10% dimming 120/277V with Power Factor of >.9. Barbican works with most Control and Driver manufacturers including POE and can easily modify the driver housings for special control gear. Fixtures over 96W may require more than one driver per fixture.
- Emergency fixtures are supplied with leads and KO for UL924 relays (by others). Battery back up will usually only drive one or two of the cores in larger fixtures to maintain the 90 minute requirement. Maximum distance driver to fixture 15 feet.
- Labels:** ETL US and Canada, CE Europe and Middle East (Dry, Damp indoor use only)
- Finish:** Polyester Powder Coated standard, Hand Brushed Aluminum
- Lumen Maintenance:** Reported L90 > 10,000hrs, Calculated > 60,000hrs (TM-21)
- Warranty:** 5 years limited at 25 Celsius. Contact Barbican for additional information.

LABELS



ETL/CE
Listed



Dry/Damp
Rated



5 Years
Warranty



Power Over
Ethernet



Tunable
White



RGBW
Color Tuning



Full
Spectrum

HPC3

T-WELD

EXAMPLE LAYOUT (1/2)

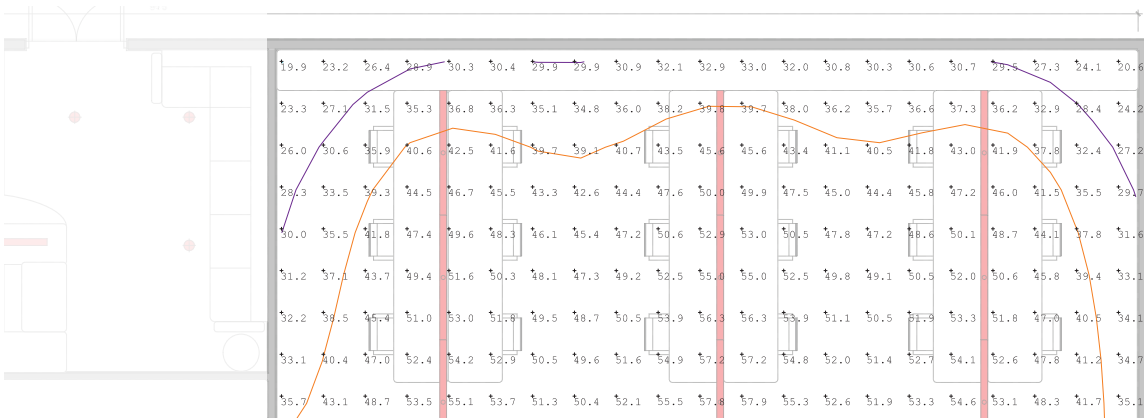
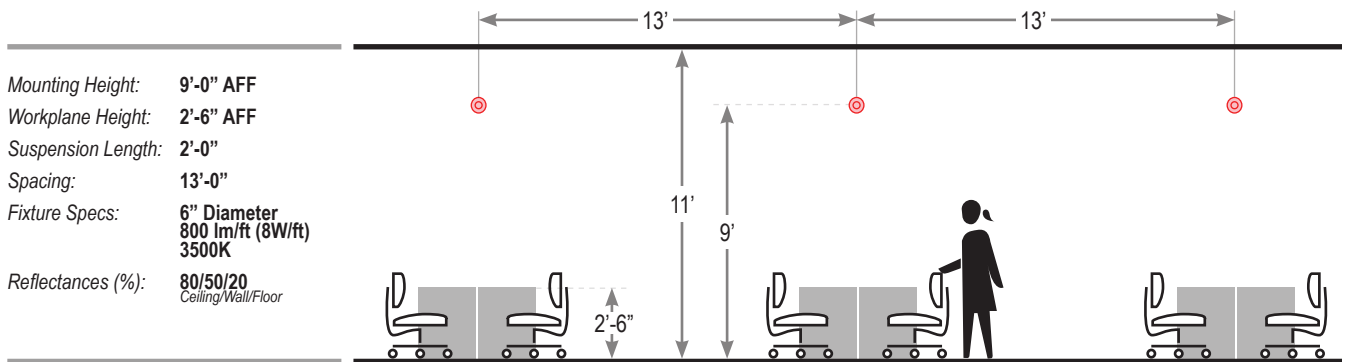
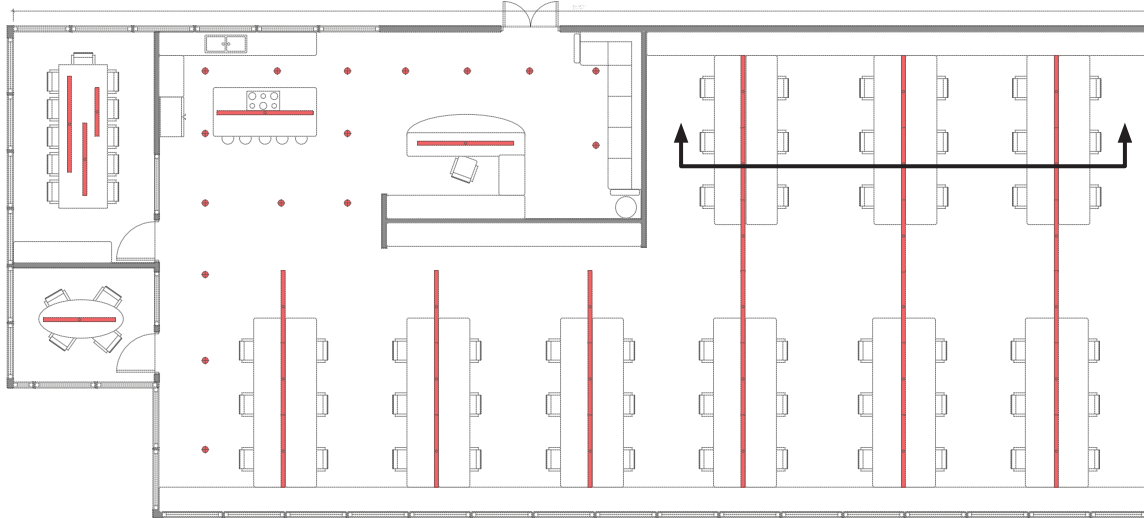

EXAMPLE LAYOUT (1/2)

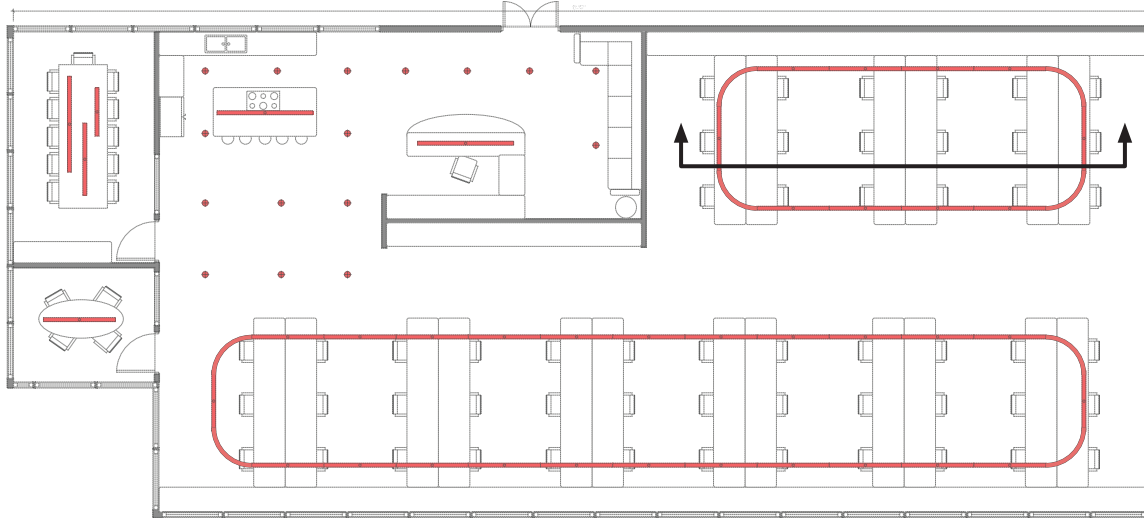

- Mounting Height: **9'-0" AFF**
- Workplane Height: **2'-6" AFF**
- Suspension Length: **2'-0"**
- Fixture Scale: **12'-0" x 30'-0"**
- Fixture Specs: **6" Diameter
700 lm/ft (7W/ft)
3500K**
- Reflectances (%): **80/50/20
Ceiling/Wall/Floor**

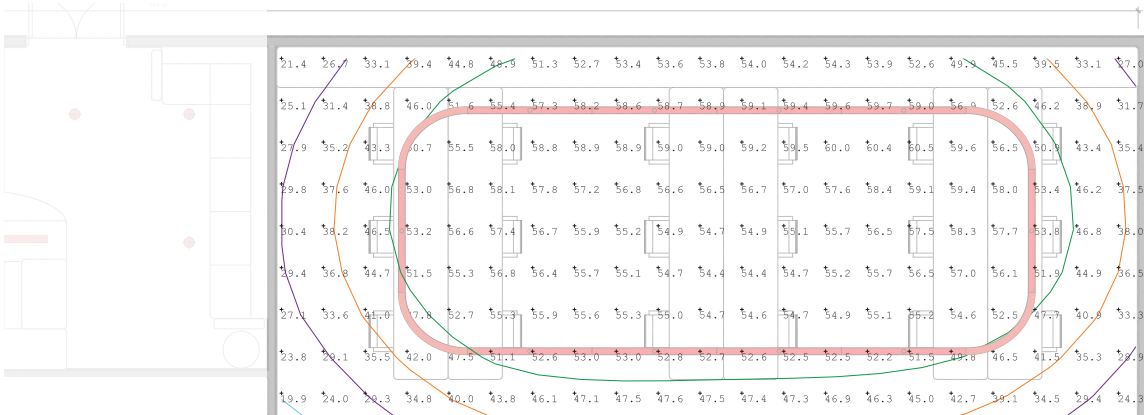
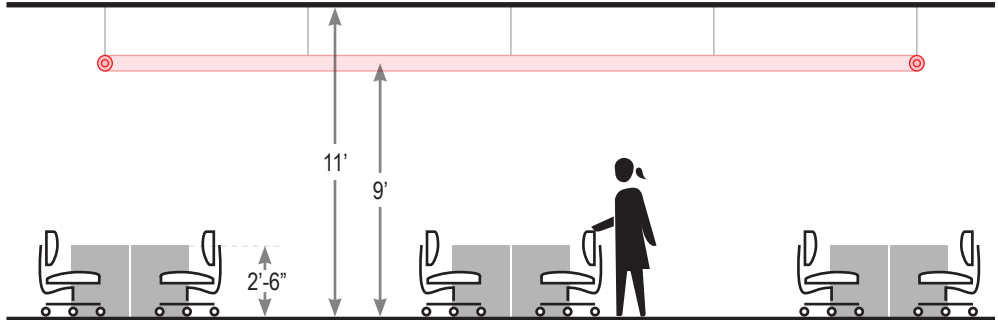

APPLICATIONS



Lighting Designer: **AE Design**; Architect: **IA Interior Architects**; Photographer: **Madeline J Studios**

International Co-Working Space

An international co-working client required a 6" HPC³ with custom outputs as well as CE/ETL listed versions for installations worldwide. Special swappable end-caps were developed with the client's design team to provide a distinct color-matched branding in all locations.



APPLICATIONS



Designer: Andrew Cook; Photographer: Ric Marder Imagery

Midtown NYC Conference Space

This Midtown New York City office used the modular nature of the **HPC3** Curve as well as the on-site rotation to create this impactful and unique center piece for their conference room. This installation uses all standard HPC3 Curve sections.

FIXTURE CONFIGURATIONS

Cross Sections

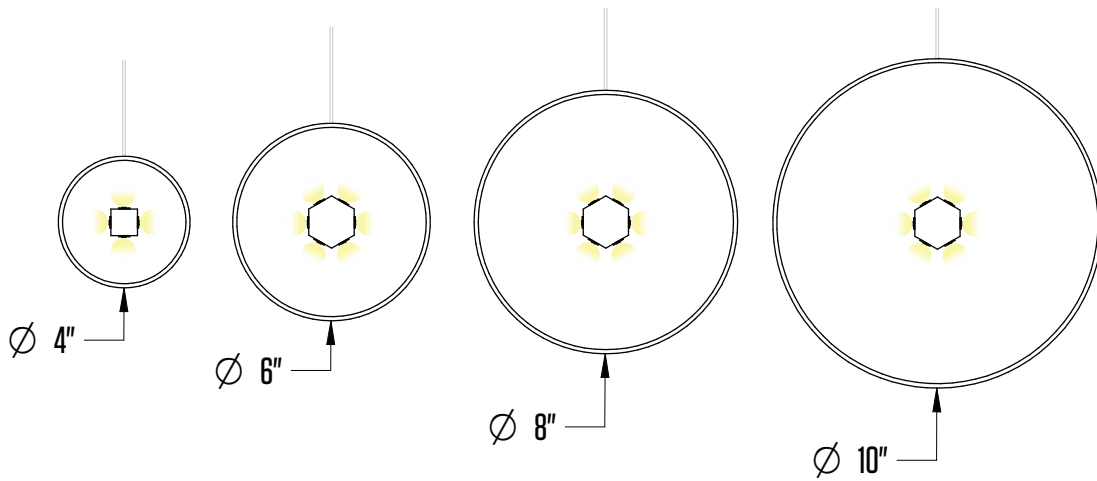

Straight Sections

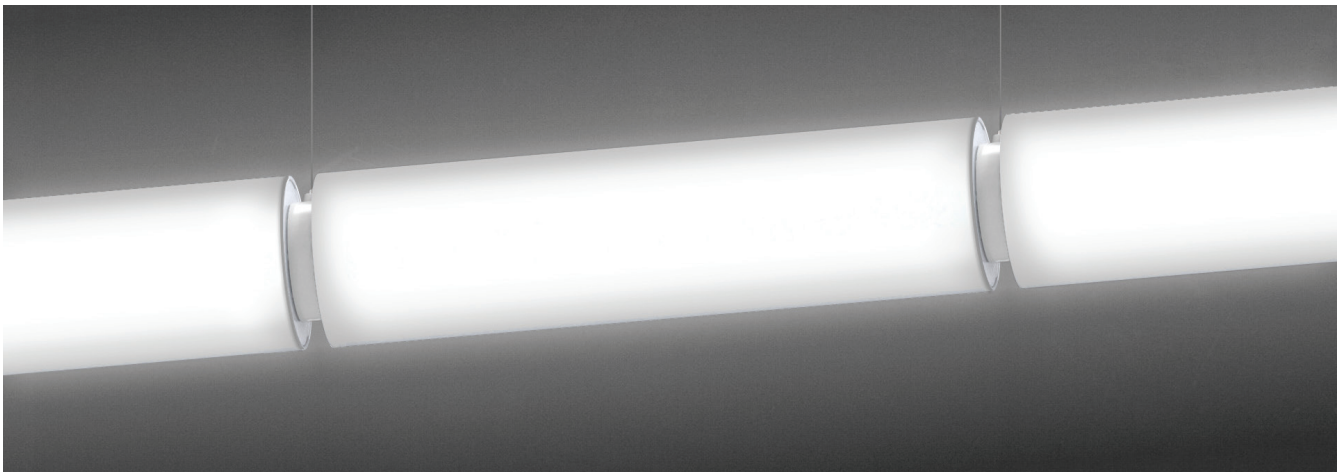

AVAILABLE CONFIGURATIONS

Curved Bends



Click [here](#) for Stand Alone Curved Bend specifications and options.

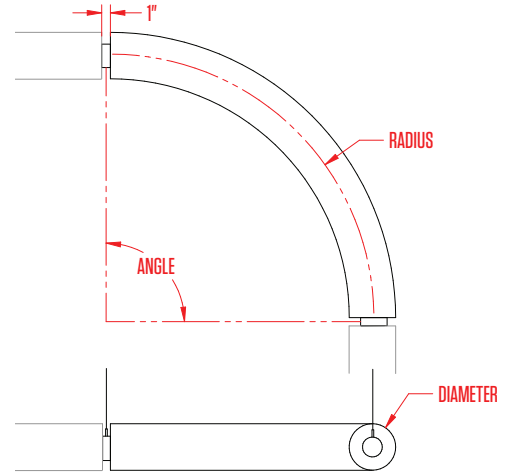

Radius Options: 24", 36", 48"
Angle Options: 45°, 90°, custom
Diameter Options: 4", 6"

L-Weld Corner



Click [here](#) for Stand Alone L-Weld specifications and options.

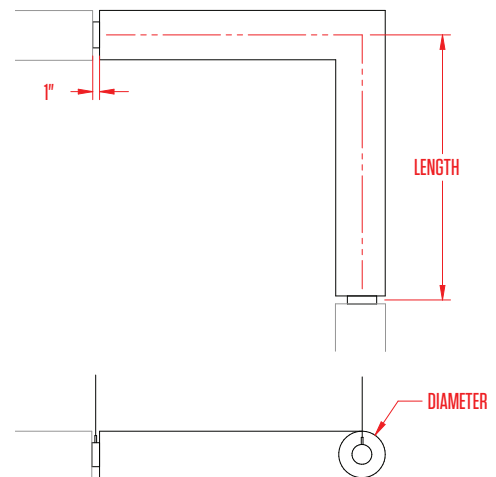

Length Options: 24", custom
Angle Options: 45°, 135°, custom
Diameter Options: 4", 6", 8", 10"

AVAILABLE CONFIGURATIONS (cont.)

T-Weld Corner

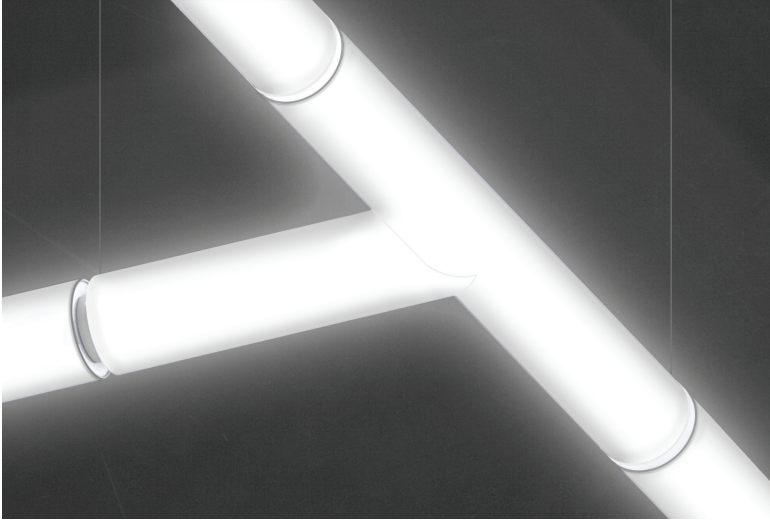

Click [here](#) for Stand Alone T-Weld specifications and options.

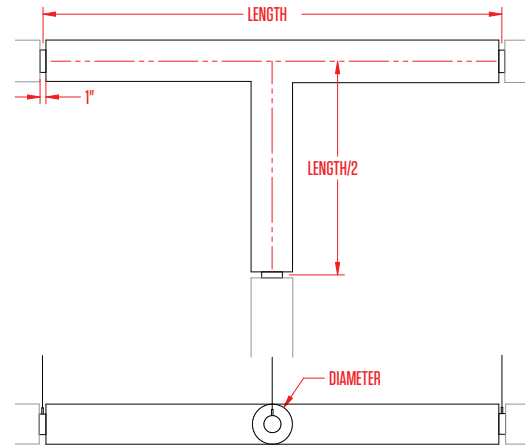

Length 1 Options: 48", custom
Length 2 Options: 24", custom
Diameter Options: 4", 6", 8", 10"

X-Weld Junction

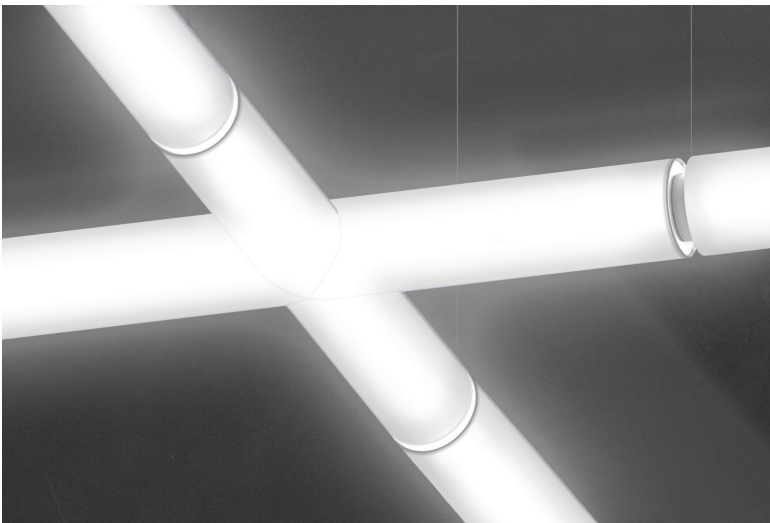

Click [here](#) for Stand Alone X-Weld specifications and options.

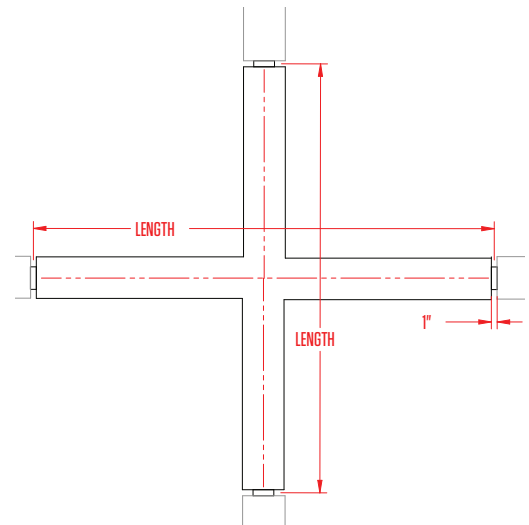

Length Options: 48", custom
Diameter Options: 4", 6", 8", 10"

HPC3

T-WELD

AVAILABLE CONFIGURATIONS (cont.)

Column



Click [here](#) for Stand Alone Column specifications and options.

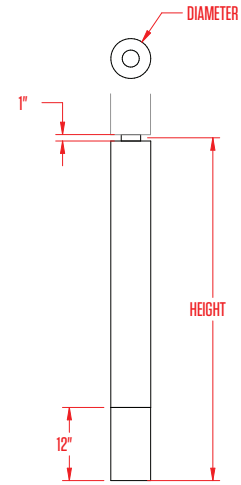

Height Options: **48", 60", 72", 84", 96", custom**
Diameter Options: **4", 6" - Wall/Ceiling Supported**
8", 10" - Floor Mount

Consult Factory for other options

SPECIFICATION DETAILS (cont.)

Surface Canopy (SC)

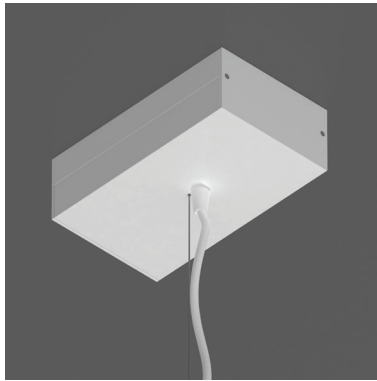

White Power Cord



Black Power Cord

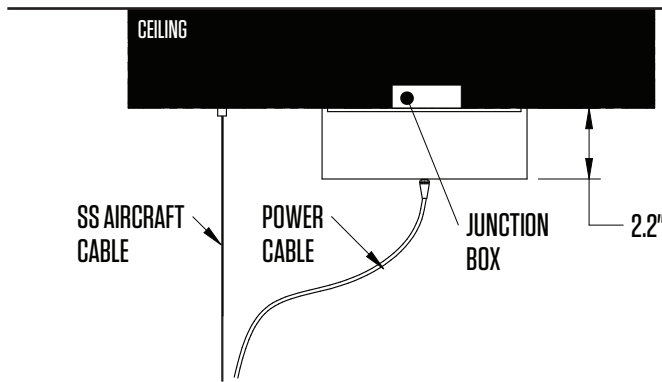
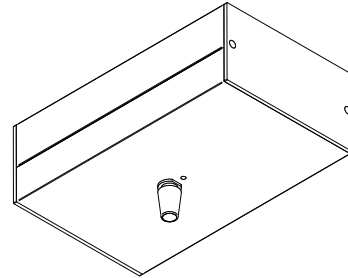

Offset Surface Ceiling Location Mounting Side View

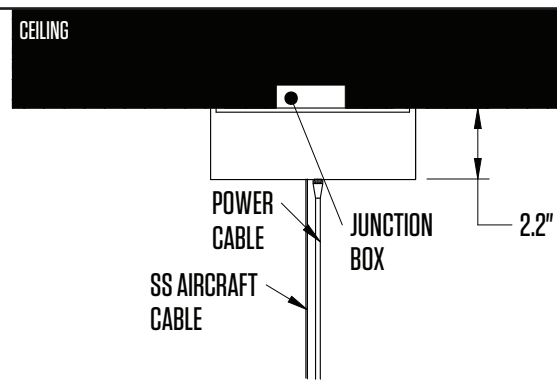

Surface Ceiling Location Mounting Side View

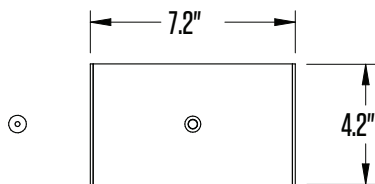

Offset Surface Ceiling Location Mounting Bottom View

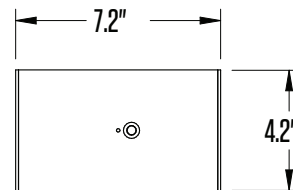

Surface Ceiling Location Mounting Bottom View

HPC3

T-WELD

SPECIFICATION DETAILS (cont.)

Remote Driver (RD)

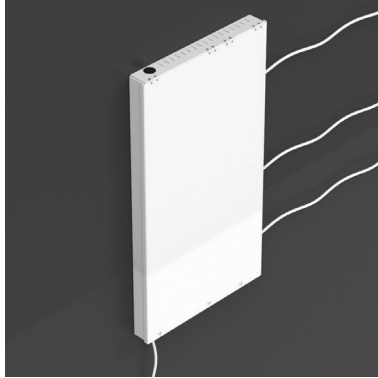

White Power Cord

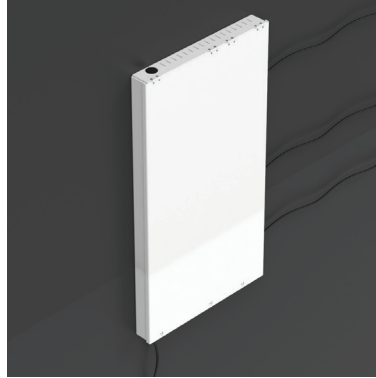

Black Power Cord

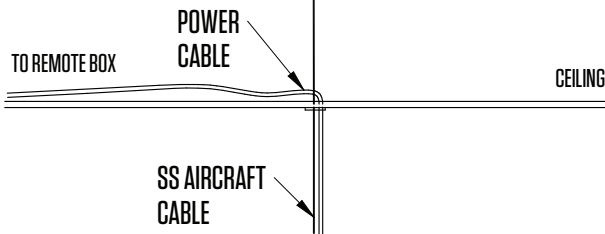
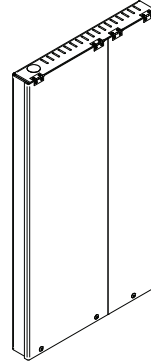

Acoustic Ceiling Power Supply Box Mounting Side View

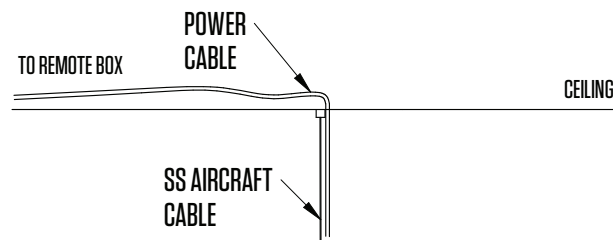

Solid Ceiling Power Supply Box Mounting Side View



Ceiling Finishing Plate

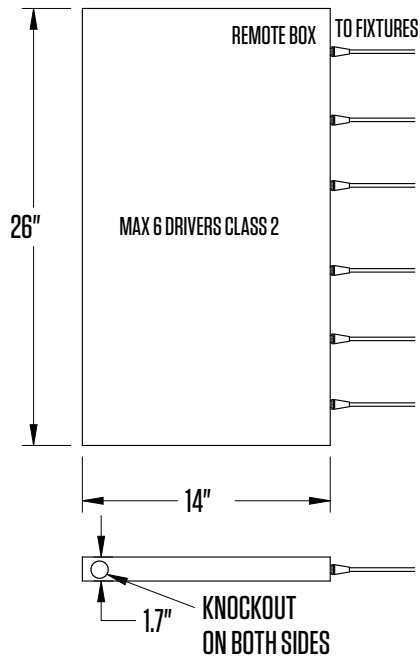

Power Supply Box Dimensions

SPECIFICATION DETAILS (cont.)

ACT Remote Driver (AD)

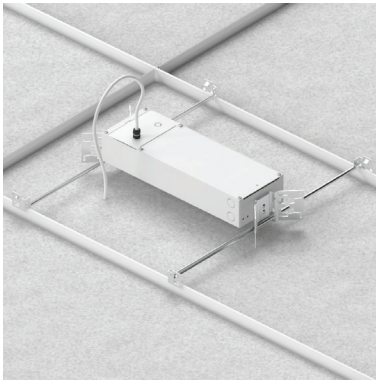

Driver Housing

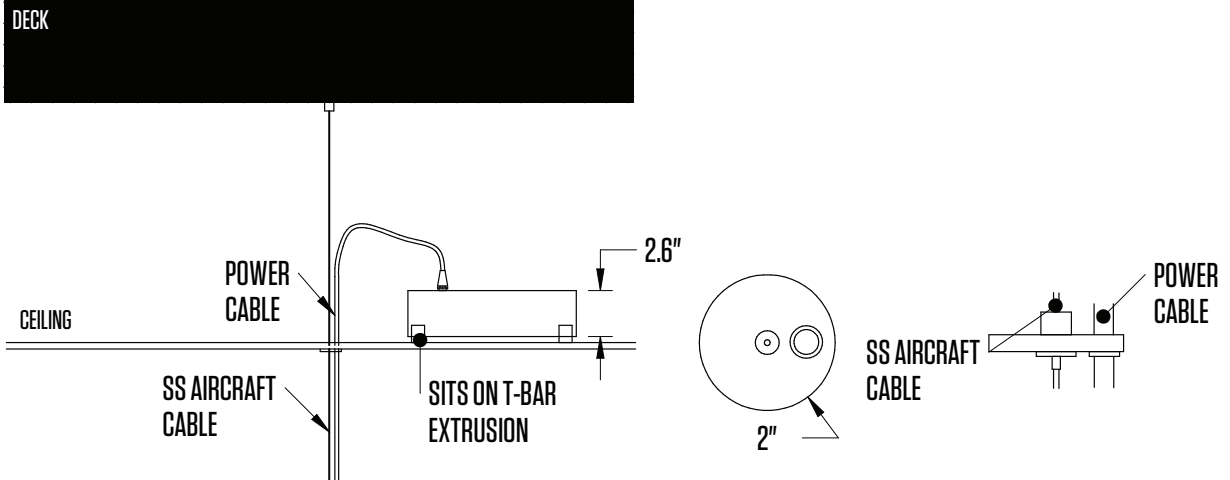
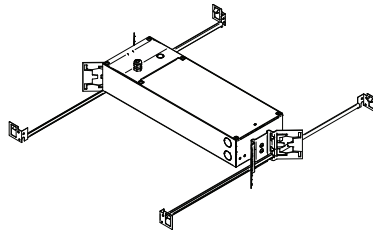

Above Ceiling Location Mounting Side View

Ceiling Finishing Plate

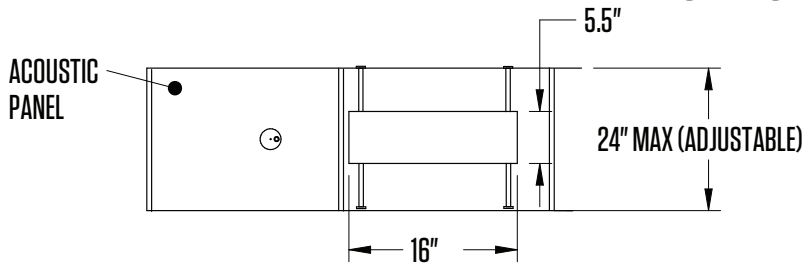

Above Ceiling Location Mounting Top View

SPECIFICATION DETAILS (cont.)

Recessed Canopy (RC)



White Power Cord



Black Power Cord

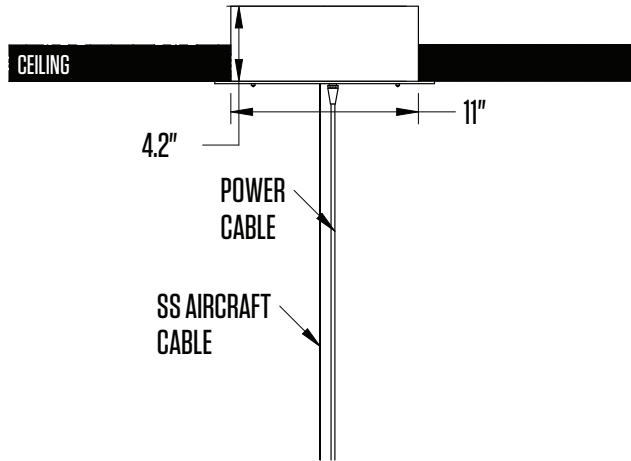

Flush Ceiling Location Mounting Side View

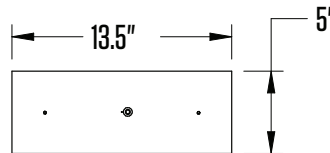

Flush Ceiling Location Mounting Bottom View

QUICK SHIP

 **10 day quick-ship**

Barbican's Quick Ship program offers a **two-week (10 business day) lead time** for specific standard fixtures with select options. The standard fixtures in this program include HPC³ Straight, Drum, Halo and HPC. See spec sheet and website for available options.

HPC3 Straight is available in quantities **up to 50 fixtures per order**. Quick ship date will be confirmed at time of quotation if the order is placed within 5 working days. The order will be acknowledged within 24 hours of receipt of a clean PO. **A clean PO must include the correct catalog numbers, quantities and "Quick Ship" clearly identified.**

Lead time will be 10 business days from the acknowledgment date.

Larger quantities and additional options may be possible.

10 day lead time does not include factory Summer, Christmas or Government mandated shutdowns, statutory holidays (Canadian) or weekends. Change orders will affect lead time and may incur additional costs. Please consult factory.

Barbican cannot be held responsible for any delivery delays caused by the freight company after the product has left our facility. The freight company is solely responsible for any delays. Barbican will accommodate the customer's own freight company on request.

Note that Barbican may be able to ship other products in an expedited manner. Please consult Barbican for lead times.