

Line Voltage Passive Infrared Fixture Integrated Outdoor Sensor BRI823-B-D Instruction



BRI823-B-D



RC-100
(OPTIONAL)

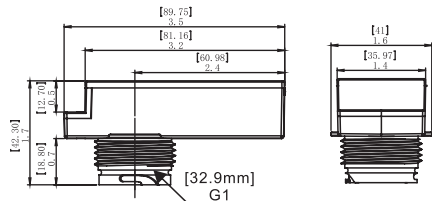

Unit:mm/in

Product brief

The BRI823-B-D mounts in an outdoor lighting fixture and provides multi-level control based on motion and/or daylight contribution. It controls 0-10 VDC LED drivers or dimming ballasts, as well as non-dimming ballasts and, with an Fresnel Lens, is rated for wet and cold locations. All control parameters are adjustable via a wireless configuration tool capable of storing and transmitting sensor profiles.

Technical parameters

- 120/277 VAC, 50/60Hz
- Resistive/Halogen - 800W/1200W@120/277V
- Fluorescent Ballast - 660W/1200W@120/277V
- Electronic Ballast (LED/CFL) - 5A/5A@120/277V
- Detect Area: 360°, maximum coverage 60' diameter from 40' height
- High mode: 0-10 V; default 10 V
- Low mode: Off, 0-9.8 V; default 1 V
- Operating temperature: -40-158°F (-40-70°C)
- Operating Humidity: 20-90%
- IP66 for PIR LEN(top part of the sensor)
- Five year warranty

Function and options

1. Bi-Level control

The PIR sensor to achieve tri-level dimming control, for same areas that require a light change notice before switch off. It offers 3 levels of the light Control : 100%--dimming light (0,10%,30%,50%)--off;and 2 periods of selectable waiting time: motion hold-time and stand-by time. Selectable daylight threshold and choice of detection area.

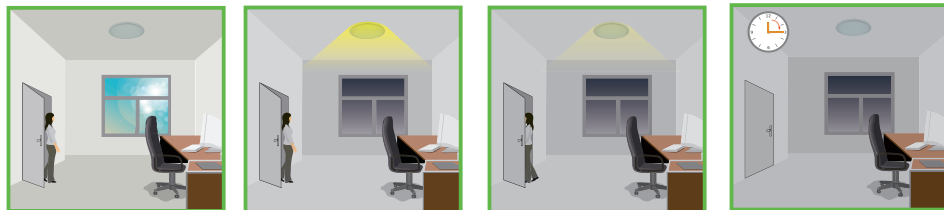

With sufficient natural light, the light does not switch on when presence detected.

With insufficient natural light, the sensor switches on the light automatically when person enters room.

People left, light still dims to 0/10%/30%/50% (options) standby level after the hold time.

Light switches off automatically after after stand-by time elapsed.

Line Voltage Passive Infrared Fixture Integrated Outdoor Sensor BRI823-B-D Instruction

2. Photocell(Daylight sensor) Control

In condition by setting, Press **Ⓜ**, the photocell(Daylight sensor) on/off setpoint is open. When the light level exceeds this setting, the lights will turn off even when the space is occupied. Once the light level exceeds this setting, the sensor will wait and monitor for 1 min in order to confirm the light level increase is not temporary before forcing the lights to go off. When light level goes below the settings, the light will turn on even without motion detection after 1min. This feature is disabled by default.



If with insufficient natural light, the light automatically dims to 0,10%, 30%, 50%.

With insufficient natural light, the sensor switches 100% on the light automatically when person enters the room.

People left, light dims to 0/10%/30%/50% (options) standby level after the hold time.

The ligh still dims to 0/10%/30%/50% if still insufficient natural light, the light never switch off until sufficient natural light.

Light will switch off automaticly even with presence detected, if the nature light is sufficient.

Sensor module

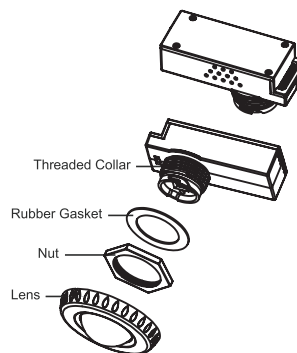

Mounting

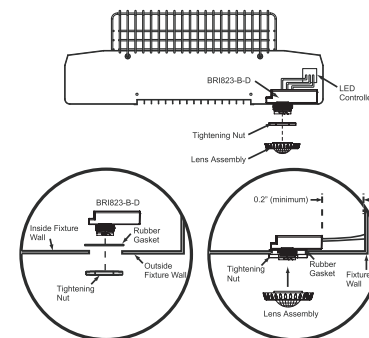

Coverage Patterns

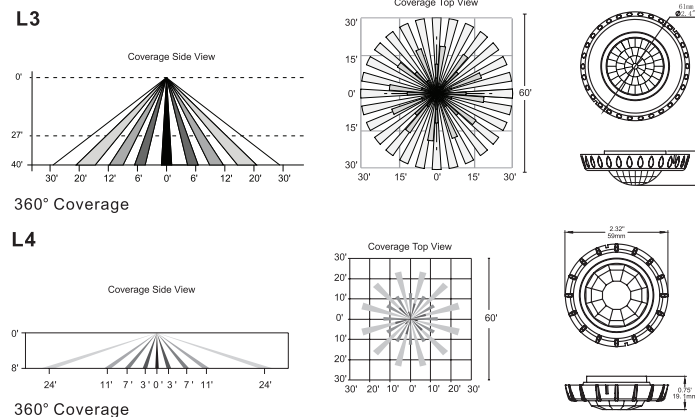

Line Voltage Passive Infrared Fixture Integrated Outdoor Sensor BRI823-B-D Instruction

PARAMETER SETTING BY DIP SWITCH

Consider the picture: 1, 2 set sensitivity; 3, 4 set hold time; 5, 6 set the lux; 7, 8 stand-by light level ; 9, 10 set stand-by time ;



Detection Range Setting (sensitivity)

Detection range is the term used to describe the radii of the more or less circular detection zone produced on the ground after mounting the sensor light at a height of 40ft, pull switch to the ON position as "↑", pull switch to the OFF position as "↓", switch location and detection range of the corresponding table is as follows:

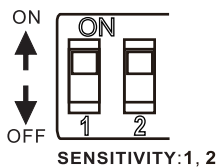

SENSITIVITY	
1	2
↓ ↓	20%
↓ ↑	50%
↑ ↓	75%
↑ ↑	100%

Hold Time Setting

The light can be set to stay ON for any period of time between approx. 10sec and a maximum of 60min. Any movement detected before this time elapse will re-start the timer. It is recommended to select the shortest time for adjusting the detection zone and for performing the walk test. Pull switch to the ON position as "↑", pull switch to the OFF position as "↓", switch location and detection range of the corresponding table is as follows:

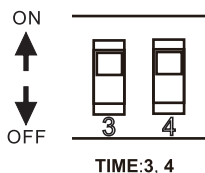

TIME	
3	4
↓ ↓	10S
↓ ↑	10Min
↑ ↓	30Min
↑ ↑	60Min

Light-control Setting

The chosen light response threshold can be infinitely from approx. 10-50lux, pull switch to the ON position as "↑", pull switch to the OFF position as "↓", switch location and light-control of the corresponding table is as follows:

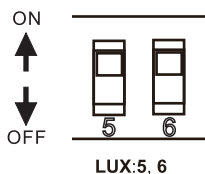

LIGHT	
5	6
↓ ↓	☀ (light sensor disable)
↓ ↑	10Lux
↑ ↓	30Lux
↑ ↑	50Lux

Line Voltage Passive Infrared Fixture Integrated Outdoor Sensor BRI823-B-D Instruction

Stand-by Light Level Setting

Switch to the on is "↑", switch to the off is "↓"; he corresponding file of switch location and detection distance as follow:

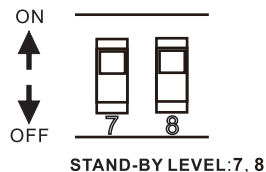

STAND-BY LEVEL	
7	8
↓ ↓	0%
↓ ↑	10%
↑ ↓	30%
↑ ↑	50%

Stand-by Time Setting

File of switch location and detection distance as follow: file of switch location and detection distance as follow:



STAND-BY TIME	
9	10
↓ ↓	+∞
↓ ↑	1Min
↑ ↓	30Min
↑ ↑	60Min

PARAMETER SETTING BY REMOTE CONTROL IN MANUAL OF RC-100

Wiring Diagrams

BRI823-B-D wiring with dimming ballast or LED driver.
Dimming Driver

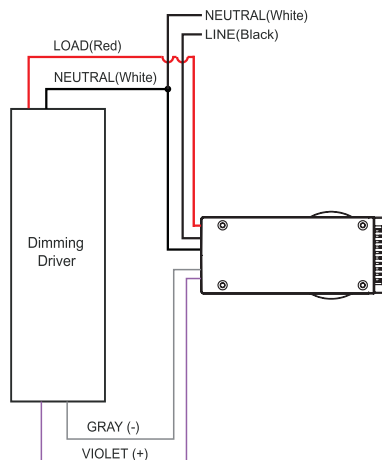

BRI823-B-D wiring with non-dimming ballast or LED driver.
Non-Dimming Driver

