

DESCRIPTION

The ASYX 2.0 second generation of asymmetric lighting is designed for general ambient illumination and accenting architectural features. The luminaire allows for both forward and wide distributions as well four different color temperatures to accommodate any space. The ASYX 2.0 utilizes the patented and highly efficient AccuLED Optics™ system for industry leading performance. IP66 rated and optional natatorium finish.

Catalog #		Type
Project		
Comments		Date
Prepared by		

SPECIFICATION FEATURES

Construction

Heavy-wall die cast aluminum end caps with extruded aluminum housing. Housing fins allow for air flow and thermal management. Fixture is rated to 40°C. Weight: 42 lbs

Electrical

Standard drivers feature electronic universal voltage (120-277V/ 50-60 Hz), greater than 0.9 power factor, less than 20% harmonic distortion, and ambient temperature range of 40°C (104°F) to minimum starting temp of -30°C (-22°F). 0-10V dimming standard with DALI option available. Max amp draw @ 120V is 1.5 Amps.

LED Optics

ASYX 2.0 luminaire utilizes patented, high efficiency AccuLED Optics with specific optical distributions. Each lens is injection molded for precision, arranged and sealed onto a board substrate. LEDs are industry leading high output with standard product at 93% lumen maintenance at 60,000 hours. Offered

in 80+ CRI for 2700K, 3000K, and 3500K CCT, and 70+ CRI for 4000K CCT. The ASYX 2.0 also offers +/- 90°, or 180° rotated optics to adjust distribution for any location. The HSS option provides maximum backlight control.

Mounting

Die cast adjustable knuckle, bolts to housing. Fixture mounts to recessed junction box (by others) using wall plate, or surface mount box with conduit entry option. See installation instructions for mounting conditions to ensure adequate support. Fixture has continuous adjustability, 20° up to 20° down with locking mechanism, as well as upward facing or downward facing.

Finish

Fixture housing is coated using electrostatically charged polyester powder coat paint for superior protection against fade and wear. Mounting plate and all accessories to match specified color of luminaire housing. Standard colors include white, silver, black, bronze, and custom RAL color match available.

Compliance

Components are UL recognized and luminaires are cULus listed for 40°C ambient environments, wet location listed, and RoHS compliant. IP66 Rated.

Environment

Suited for indoor, outdoor (wet location listed, IP66 rated). See details below. Natatorium fixtures are also suitable for applications in salt water environments.

Natatorium

Construction consists of specialized protective coating on all metal components, stainless steel hardware, and sealed LEDs. 80% lumen maintenance at 60,000 hours. Salt Fog testing per ASTM B117-73.

Control

Standard offering is 0-10V dimming down to 10%. A Fifthlight DALI adapter is available for DALI compatibility. An integrated sensor is available with the standard driver for standalone occupancy detection and daylight sensing.

Life and Warranty

Standard five-year limited warranty on all parts.

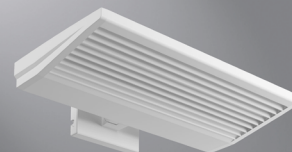

ASYX-WM S4 LED

Wall Mount
Asymmetric Direct
Asymmetric Indirect

CERTIFICATION DATA
UL/cUL Wet Location Listed
LM79 / LM80 Compliant
IP66 Rated
DLC qualified product

ENERGY DATA
>0.9 Power Factor
<20% Total Harmonic Distortion
120V - 277V 50/60 Hz
-30°C Min Temperature
40°C Max Temperature

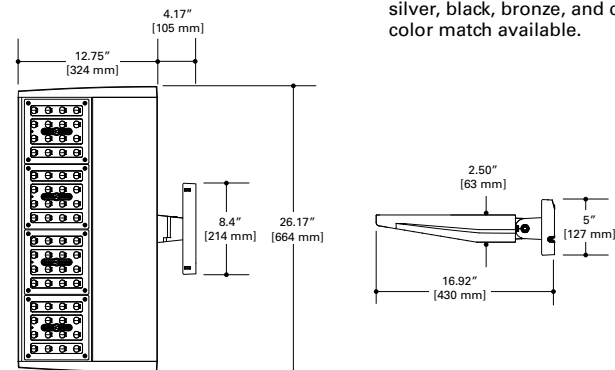

ORDERING INFORMATION

Sample Number: ASYX-WM-S4-ID-U-F-L35-1-UNV-W-R-STD-SVDP2-R90

Series	Mounting	Size	Light Level	Environment	Orientation ⁽¹⁾	Distribution	Color Temperature (Wattage for WM-S4 = 214 W)				# of ⁽⁴⁾ Circuits	Input Voltage
							L27 Delivered Lumens	L30 Delivered Lumens	L35 Delivered Lumens	L40 Delivered Lumens		
ASYX = Asymmetric LED Luminaire	WM = Wall Mount	S = Small	4 = 4 Light Square, (see Color Temp for CCT, lumen output, and wattage)	ID = Indoor OD = Outdoor NT = Natatorium	U = Uplight D = Downlight	F = Forward throw	17,197	18,085	18,972	22,055	1 2	UNV 347
						W = Wide throw	17,406	18,304	19,203	22,323		
						HSS = Backlight Shielded	11,522	12,116	12,711	14,776		

Finish	Mounting Surface	Extension Arm Length ^(2,5)	Driver Options	Integral Control ⁽¹⁾⁽³⁾ (Optional)	Optical Orientation (Optional)	Options ⁽⁵⁾ (Optional)	Accessories ⁽³⁾ (Optional)
W = White S = Silver B = Black Z = Bronze C = Custom Color	R = Mounting Plate (recessed j-box) C = Canopy Box (surface j-box)	18 = (18" extension arm) 30 = (30" extension arm) XX = Custom length. (Specify length from 10" to 30") (XX) custom extension arm lengths require longer production lead times	STD = Standard 0-10V 5LTDAC = Fifth Light DALI DAC	SVDP2 = Standalone Occupancy/Daylight Sensor	R90 = Optics Rotated 90° right from standard L90 = Optics Rotated 90° left from standard 180 = Optics Rotated 180° from standard	RM = Rigid Fixed Knuckle FM = Flush Mount	ISHH-01-A = Programming Remote for field adjustment of integrated sensor ISHH-02-A = Programming Remote for temporary control of integrated sensor

PHOTOMETRICS

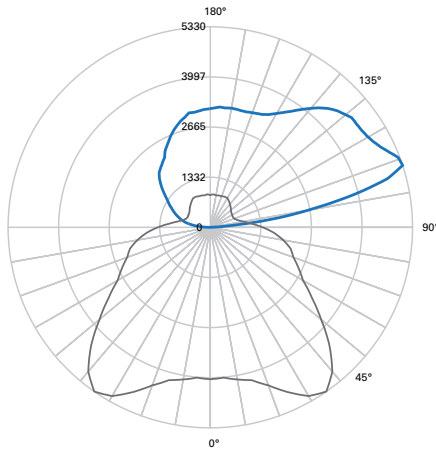

Vertical Distribution through peak candela

Horizontal Distribution through peak candela

FILE NAME: ASYX-X-S4-X-U-F-L40-1-UNV-X-X-X-STD

LAMP: 4000K

OPTIC DISTRIBUTION: Forward

DELIVERED LUMENS: 22054.6

INPUT WATTS: 214.2 W

EFFICACY: 102.9 LPW

TEST REPORT: P213143

ZONAL LUMEN SUMMARY

Zone	Delivered Lumens	% Fixture
90°-100°	705.7	0.032
100°-110°	2964.1	0.1344
110°-120°	4036.0	0.183
120°-130°	3961.0	0.1796
130°-140°	3583.9	0.1625
140°-150°	2886.9	0.1309
150°-160°	2130.5	0.0966
160°-170°	1420.3	0.0644
170°-180°	454.3	0.0206
0°-180°	22054.6	1

LUMEN MAINTENANCE

Ambient Temperature	TM-21 Lumen Maintenance (60,000 Hours)	Theoretical L90 (Hours)
25°C	> 96%	130,000
35°C	> 93%	91,000
40°C	> 95%	117,000

DISTRIBUTION

F - Forward Throw Distribution

W - Wide Throw Distribution

HSS - HSS Distribution

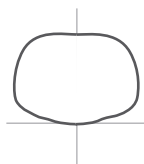
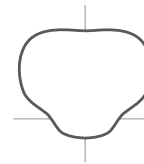
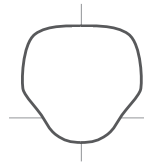

PRODUCT LINE OVERVIEW

ASYX 2.0 SUMMARY TABLE (Based on 4000K, Wide Throw Distribution)

PRODUCT NAME:	MOUNTING	SL	S1	S2	S3	S4	L3	L4	L5	L6
NUMBER OF LIGHT SQUARES:		1	1	2	3	4	3	4	5	6
DELIVERED LUMENS:	WM/SP	3,355	5,419	11,084	16,656	22,323	17,287	22,512	28,879	34,072
	DP	6,710	10,838	22,168	33,312	44,646	34,574w	45,024	57,758	68,144
	QP	13,420	21,676	44,336	66,624	89,292	69,148	90,048	115,516	136,288
WATTAGE:	WM/SP	28	55	107	158	214	160	215	268	319
	DP	55	110	214	316	428	320	430	536	638
	QP	111	220	428	632	856	640	860	1,072	1,276
LPW:		121	99	104	105	104	108	105	108	107
HID EQUIVALENT:	WM/SP	39 W	70 W	150 W	250 W	320 W	250 W	320 W	400 W	2 x 250 W

OPTIC ORIENTATION

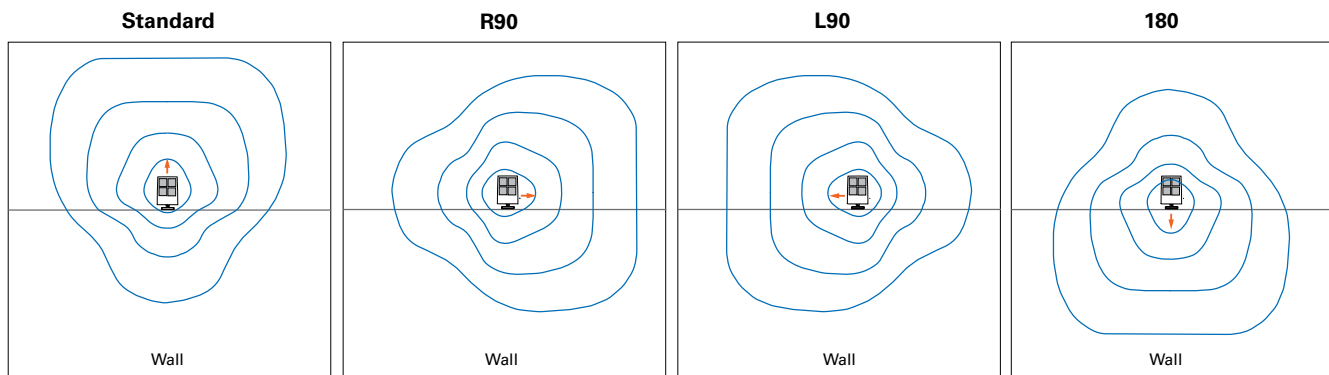

MOUNTING AND AIMING

R - Recessed junction box option: 8.4" x 5" wall plate mounts to standard junction box.

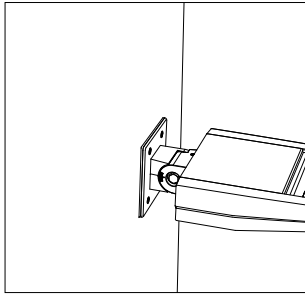

C - Conduit Entry option: Surface metal box fits over standard junction box with conduit entry option on all sides.

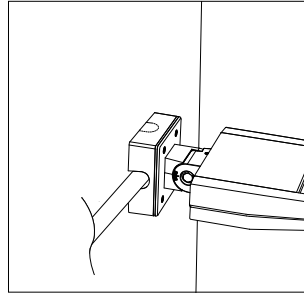

Mounting Plate

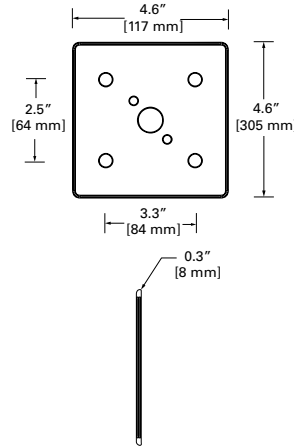

The ASYX 2.0 features +/-20° adjustable aiming as standard

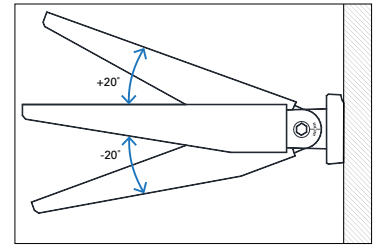

CONTROL

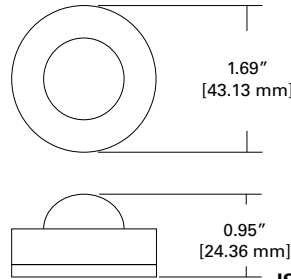
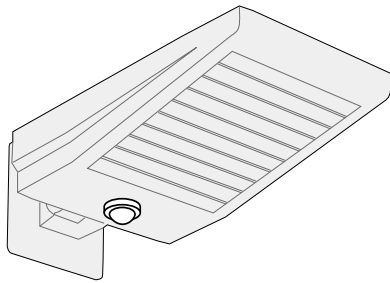

SVPD2 - The integral sensor option requires no additional wiring or special installation. The sensor provides standalone occupancy detection using a passive infrared sensor and provides daylight sensing using a closed-loop harvesting system. Depending on the "Environment" specified for Asyx, the following settings will be default:

- Indoor - Turns on/off with occupancy, daylight harvests down to 10% output
- Outdoor - Turns on/off with occupancy, turns off with sufficient daylight
- Natatorium - Full output with occupancy, 50% after occupancy timeout period, daylight harvests down to 10% output

ISHH-01-A - Programming Remote for field adjustment of Integrated Sensor
ISHH-02-A - Programming Remote for temporary control of Integrated Sensor

OPTIONS

FM - Optional flush mount option for minimized affect. FM option is not adjustable.

RM - Optional rigid knuckle mount for down ward facing, optic applications. Available in standard optic orientation only.

Extension Arm Length: Specify to the inch between min and max length

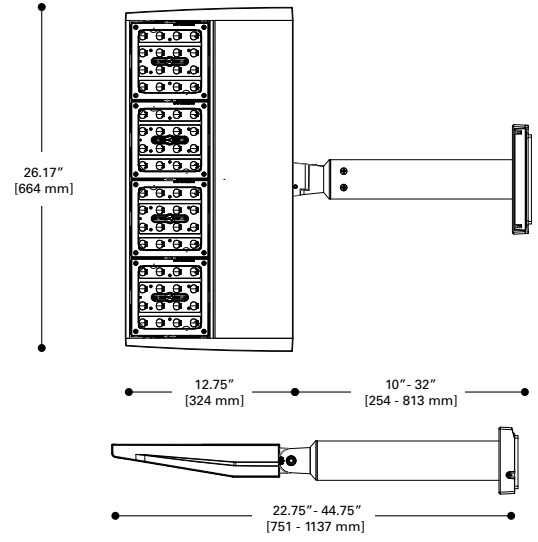
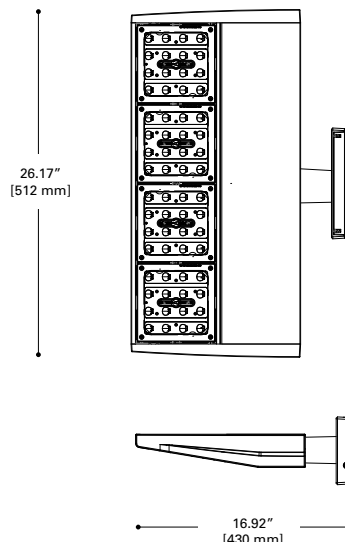
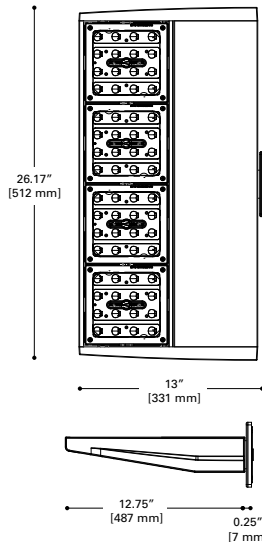

TECHNICAL NOTES

1. Integral Sensor cannot be selected in "D", downlight orientation. Integral sensor available in single circuit option only and is not available with DALI option. Integral sensor optimum coverage height: 8ft for SL/S1/S2 and 40ft for S3/S4/L3/L4/L5/L6. Integral sensor color is white for "White" finish selection and brown for "silver, bronze, or black" finish selections.
2. Not available with "C" surface mount junction box option.
3. See "Control" section for explanation.
4. Second circuit option allows for 2nd driver to be wired separately.
5. RM and FM options are not available with Extension Stem Lengths.