

AKMUNV008RTxxxA



Universal DC Engines Retrofit Kits with 0-10V Dimming

- Universal Voltage (120~277) DC Engine
- Suitable for open or fully enclosed luminaires
- Suitable for luminaires with plastic and glass lenses
- Class 2 design 156lm/W at system level
- cULus Classified 1598C
- cULus Recognized 8750
- Energy Star Luminaire 2.1 Listed and CSD ^①

General Specifications

Input Voltage ^②	120~277VAC (+/- 10%)	
Input Current ^②	~0.075A @120V	~0.032A @277V
Input Power ^②	9W	
Input PF	>0.98	
THD	<20%	
Input Frequency	50/60Hz	
Module Operating Voltage	22.2VDC	
Max Lumen Output @ Full Power ^②	1404 lumens @ 4000K / 80 CRI	
Dimming Type/Range	0-10V / 100% ~ 10%	
Beam Angle	120°	
CRI	80 (standard), 90 available (MTO)	
Storage Temperature Range	-35°C to 100°C / -31°F to 212°F	
Operating Ambient Temperature Range (Ta)	-35°C to 60°C / -31°F to 140°F	
Maximum Driver Case Temperature: per UL/ 5 year warranty	90°C (194°F) / 76°C (176°F)	
Maximum Module Case Temperature	L70: Tc max=105°C (Ts=110°C) / L90: Tc max=105°C (Ts=110°C)	
Estimated Lumen Maintenance (at Max Tc)	L70= >60,000 hours / L90= 40,000 hours	
Color Consistency	Binning per ANSI C78.377-2015 @25°C; 3 SDCM	
Inrush Current / Duration	5A @ 277V / 100us	
Line Regulation / Load Regulation	<1% @100% Load / <3% @100% Load	
Total Overall Ripple LF (<300Hz)/ HF(<40kHz) peak to peak	<5% @100% Load	
Low Frequency Ripple (120Hz ripple peak to peak)	<5% @100% Load	
Flicker Percentage	<7% @100% - 20% Dimming Range	
	<5% @<20% Dimming Range	
Start-up Time / Standby Power	<500ms / <1W No Load	
Overall Size	7.4"L x 4.7"W x 0.92"H (187.96mm L x 119.38mm W x 23.35mm H)	
Wire Type/ Length	18AWG / 12" Black and White wires (Input 120~277VAC)	
	18AWG / 12" Gray and Purple wires (Dimming 0-10VDC)	
LED Quantity	48 Pcs.	
Driver Part Number	T1M1UNV0350-15L	
Module Part Number	VMU095023RTxxxA	
Weight	320g / 0.71lbs.	
Packaging: Master Carton	20pcs	
Maximum Screw Installation Torque	35in-lb (560in-ozf)	
Safety/Compliance	Component: cURus Module File #E351548; Driver File #E342838 DC Engines Retrofit Kits: cULus Classified 1598C File # E365124 RoHS Compliant Dry and Damp Location Energy Star Luminaire 2.1 Listed and CSD ^①	
RFI/EMI	FCC Part 15B Consumer, EN55015	
Input Surge Test	2.5kV Common and Differential mode (Per ES Ring Wave Test)	
Sound Rating / Noise	A / <24 dBA	
Output Type	Class 2 (approved for luminaires glass or plastic lenses)	
PCB Material / Connector Qty / Em. Connection	CEM1 / 2 / Yes	
Warranty	5 years @ Max. Tc 105°C (module) and 76°C (Driver) from the date of manufacture	

^① See page #4 "Certification Chart" for exact models.

^② Measured electrical data per UL file

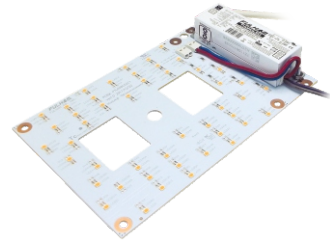
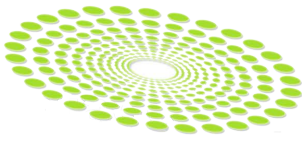

AKMUNV008RTxxxA



Part Number Matrix

A **K** **M** **UNV** **008** **RT** **8** **40** **A**

Compliance
K = DC Engine Retrofit Kit (cULus Classified)

Dimming
M = 0-10V

Input Voltage
UNV = 120V~277V

Estimated Power
008 = 8W

Shape
RT=Rectangular

CRI
8 = 80
9 = 90

Color Temperature
27 = 2700K
30 = 3000K
35 = 3500K
40 = 4000K
50 = 5000K
57 = 5700K
65 = 6500K

Material
A = CEM1

Standard Product offering, in addition to 90CRI / 3000K. (All other options are made to order with MOQ and lead time).

DC Engine Retrofit Kit includes mounting hardware, retrofit labels, and installation instructions.

8W Rectangular DC Engine Kit

AKMUNV008RTxxxA

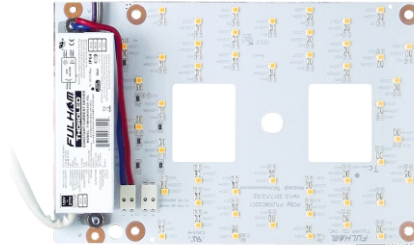

This luminaire has been modified and can no longer operate the originally intended lamp.
Ce luminaire a été modifié et ne peut plus utiliser la lampe prévue à l'origine.



Hardware Kit: TLC-HW08

UNV DC Engines Retrofit Kits with 0-10V Dimming :
Hardware, Quick disconnect, Labels & Installation Instructions

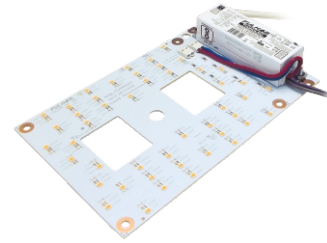
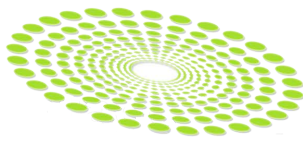

AKMUNV008RTxxxA



Typical Characteristics Graphs: Dimming and Thermal

Figure 1

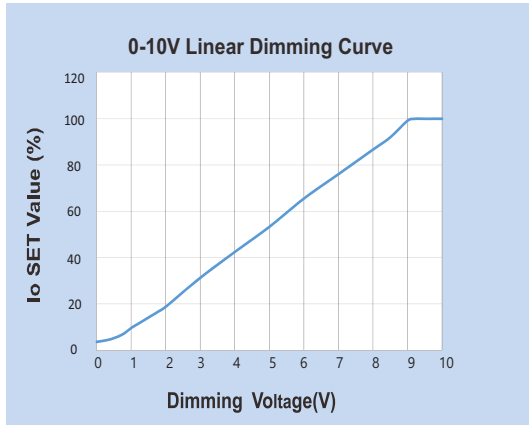
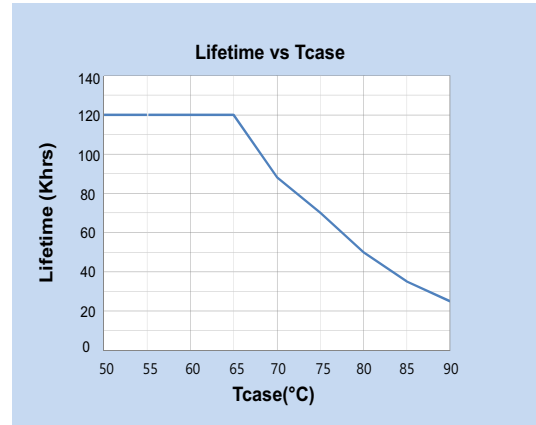
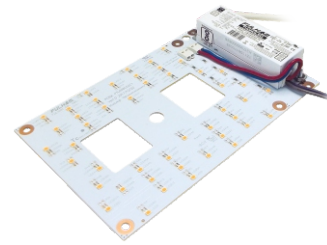
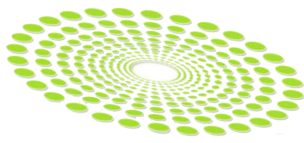

Figure 2



Failure Rate Info based upon MTBF modeling:
90% survivals at end of life @ <=Tc lifetime rating



AKMUNV008RTxxxA



Electrical and Optical Specifications

Color Temperature	DC Engine Retrofit Kit Part Number	Input Power	Nominal Luminous Flux @ 90 CRI	Engine Efficacy @ 90 CRI	Nominal Luminous Flux @ 80 CRI	Engine Efficacy @ 80 CRI
2700K	AKMUNV008RT827A	9W	1089 lumens	121 lm/W	1296 lumens	144 lm/W
3000K	AKMUNV008RT830A	9W	1170 lumens	130 lm/W	1332 lumens	148 lm/W
3500K	AKMUNV008RT835A	9W	1161 lumens	129 lm/W	1350 lumens	150 lm/W
4000K	AKMUNV008RT840A	9W	1190 lumens	132 lm/W	1404 lumens	156 lm/W
5000K	AKMUNV008RT850A	9W	1210 lumens	134 lm/W	1422 lumens	158 lm/W
5700K	AKMUNV008RT857A	9W	1210 lumens	134 lm/W	1422 lumens	158 lm/W
6500K	AKMUNV008RT865A	9W	1190 lumens	132 lm/W	1404 lumens	156 lm/W

NOTES:

- 1) Electrical and optical specifications are based on Tc mod = 25°C. Reference Amb. Temp. vs Rel. Lum. Flux for other temperatures.
- 2) Nominal luminous flux at 90 CRI are calculated values, not measured.
- 3) Performance for these components have been tested in accordance with Energy Star.
- 4) Refer to Energy Star CSD or Luminaires 2.1 for actual measurements on specific part numbers. Energy Star testing is done at elevated case temperature.
- 5) Specifications are subject to change without notice.
- 6) 70CRI is NOT available.

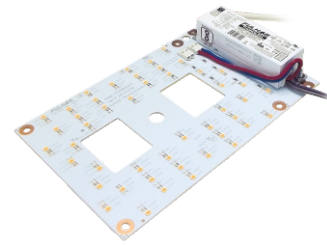
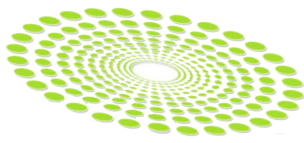

AKMUNV008RTxxxA



Thermal Specifications

③ DC Engine Retrofit Kit (A)

Storage Temperature Range	-35°C to 100°C / -31°F to 212°F
Operating Ambient Temperature Range	-35°C to 60°C / -31°F to 140°F
Maximum Driver Case Temperature	90°C / 194°F
Maximum Module Case Temperature	L70 = 105°C (221°F) / L90 = 105°C (221°F)

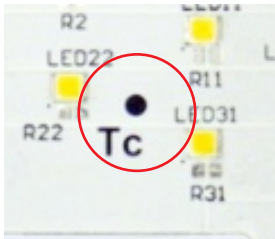

Tc located on module



Tc located on driver

Thermal De-Rating: Tc vs. Luminous Flux

Module Case Temperature (Tc)	Total Vf Multiplier	Luminous Flux Multiplier
25°C	1.000	1.000
30°C	1.000	0.991
35°C	0.997	0.982
40°C	0.993	0.973
45°C	0.993	0.964
50°C	0.990	0.953
55°C	0.987	0.944
60°C	0.987	0.935
65°C	0.984	0.926
70°C	0.984	0.917
75°C	0.980	0.908
80°C	0.977	0.899
85°C	0.977	0.889
90°C	0.974	0.880
95°C	0.970	0.862
100°C	0.967	0.853

NOTES:

- 1) Refer to DC Engine Retrofit Kit Installation Instructions for further detail.
- 2) This DC Engine Retrofit Kit can retrofit any luminaire with a dimension/volume greater or equal to the minimum dimensions shown below and on the Installation Instructions.
- 3) This DC Engine Retrofit Kit can be used with luminaires similar to the one illustrated on the Installation Instructions.

③ Suitable for surface mounted luminaire with minimum dimensions or volume: Length of 10.5", Height of 4.25", and Width of 6" or 267.75 cubic inches

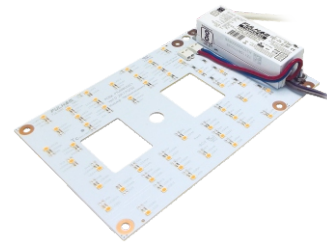
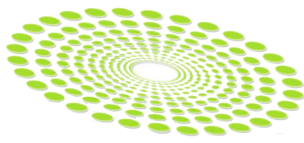

AKMUNV008RTxxxA



Certification Chart

Energy Star™ TM-21 Calculator Data

Model	VKMUNV008RTxxxA
Classification	
	YES
	YES (Driver & Module)
	YES
	YES
	YES

Tc Module	Reported L70	Reported L90
55°C	>60,000 Hrs	>54,000 Hrs
85°C	>60,000 Hrs	46,000 Hrs
105°C	>60,000 Hrs	40,000 Hrs
Tc Module	Calculated L70	Calculated L90
55°C	180,000 Hrs	54,000 Hrs
85°C	154,000 Hrs	46,000 Hrs
105°C	133,000 Hrs	40,000 Hrs

NOTES:

1) Energy Star CSD:

https://www.energystar.gov/products/lighting_fans/certified_lighting_subcomponent_database_csd

2) Energy Star Listed:

https://www.energystar.gov/productfinder/product/certified-light-fixtures/results?scrollTo=342&search_text=fulham&fixture_type_isopen=&markets_filter=United+States&zip_code_filter=&product_types=Select+a+Product+Category&sort_by=light_output_lumens&sort_direction=asc&page_number=0&lastpage=0

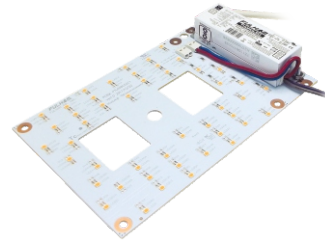
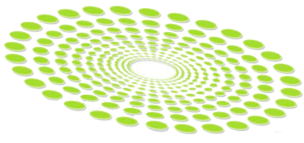

AKMUNV008RTxxxA



Mechanical Drawings

(Scale 4 : 5)

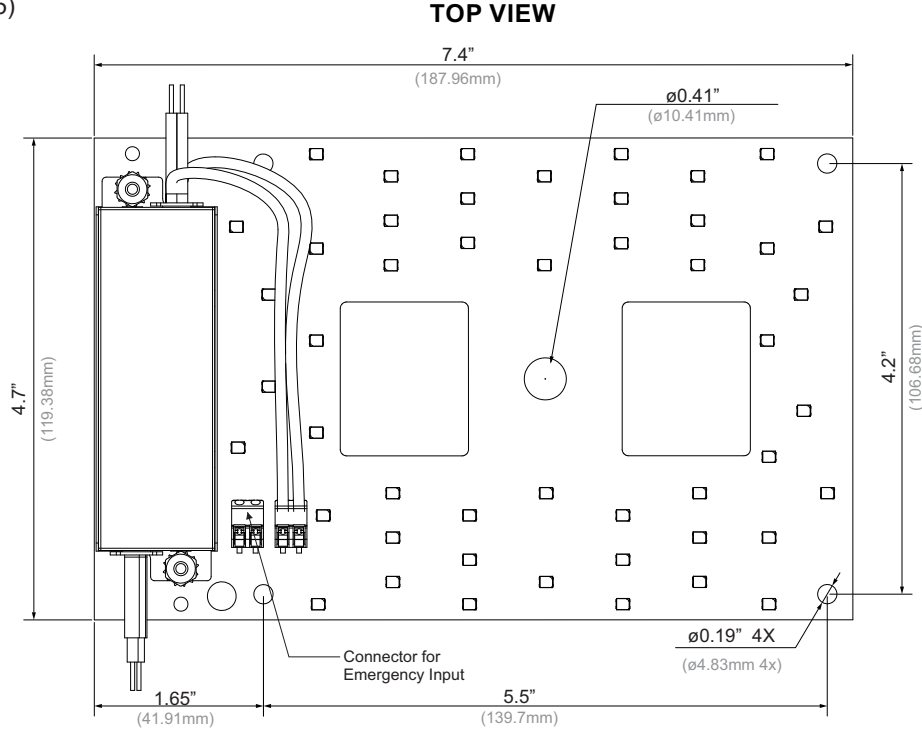

Overall Dimensions	
Length	7.4" [187.96mm]
Width	4.7" [119.38mm]
Height	0.92" [23.35mm]
Wire Length	
AC Input (Black / White)	12" [304.8mm]
0-10V Dimming (Purple (10v+) Gray (10V-))	12" [304.8mm]

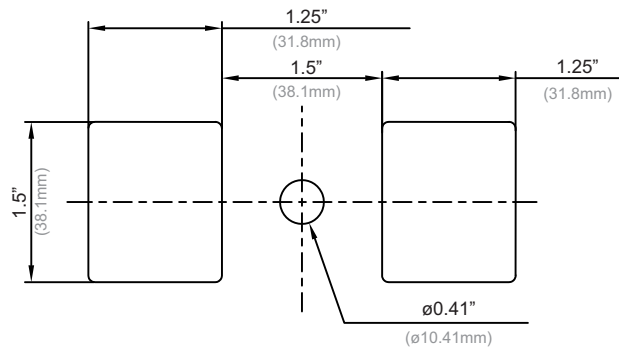

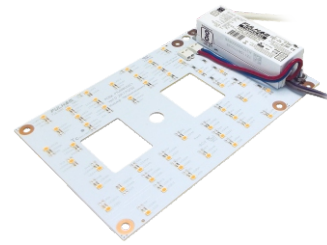
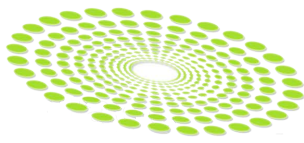

AKMUNV008RTxxxA



DC Engine Retrofit Kit Equivalency Chart: FLUO to LED

DC Engine Retrofit Kit (7.4" x 4.7" Rectangular)				CFL					
DC Engine Retrofit Kit Part Number	System Wattage	Lumen Output	Efficacy	CFL Style	Lamp Wattage	# of Lamps	Total Wattage	Lumen Output	Efficacy
AKMUNV008RTxxxA	9W	1404 lm (4K/80CRI)	156 lm/W	Quad	28W	1	28W	1680 lm	60 lm/W
					27W	1	27W	1647 lm	61 lm/W
				Triple	20W	1	20W	1240 lm	62 lm/W
					21W	1	21W	1323 lm	63 lm/W
				Quad	26W	1	26W	1664 lm	64 lm/W
					26W	1	26W	1690 lm	65 lm/W
				Triple	23W	1	23W	1518 lm	66 lm/W
					13W	2	26W	1742 lm	67 lm/W
				Circline T5	22W	1	22W	1496 lm	68 lm/W
				Circline T9	22W	1	22W	1518 lm	69 lm/W

NOTES:

- 1) LED is a point source and FLUO is 360, there is more light lost with FLUO especially during the reflection. Therefore it is recommended to use a 65 percent of the original light source total lumens when converting FLUO to LED. For example original FLUO lumens of 2000 x .65% = 1300 LED lumens. This is only a recommendation, and the installer should consider other factors for the application.
- 2) For reference only, several factors apply.
- 3) Emergency systems are not UL classified for field installation.

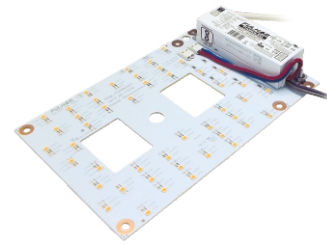
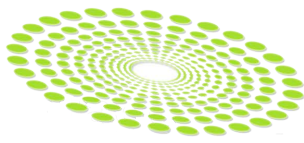

AKMUNV008RTxxxA



DC Engine Retrofit Kit with Emergency Options

NOTE: Emergency systems are not UL classified for field installation.

DC Engine Retrofit Kit Part Number	Emer. Driver Part Number	Battery Wattage	Battery Part Number	Harness (mA)	LED Vf (V)	LED If (mA)	Total Power (W)	Total Lum. Output (lm)	Eff. (lm/W)
AKMUNV008RT840A	FHS2-UNV-36L/ FHS2-UNV-56S	4W	FHSBATT8-AA9 FHSBATL3-1	FHS-HARNESS-175	21.5	175	3.8	720 [Ⓢ]	191
	FHSCP-UNV-5WL	5W	N/A	N/A	21.8	228	5.0	934	187
	FHSCP-UNV-10P-L-SD	5W	FHSBATL3-1.5-SD	N/A	21.8	228	5.0	934	187
	FHS2-UNV-36L	6W	FHSBATL6-.6	FHS-HARNESS-250	21.8	250	5.5	1022 [Ⓢ]	187
	FHSCP-UNV-10P-L-SD	6W	FHSBATL9-.6-SD	N/A	21.9	368	6.0	1124	187
	FHSCP-UNV-7.8WL	7.8W	N/A	N/A	22.2	354	7.8	1428	183
	FHS2-UNV-36L/ FHS2-UNV-56S	8W	FHSBATL3-1.5 FHSBATL3-1.5S	FHS-HARNESS-350	22.2	350	7.8	1412 [Ⓢ]	182

NOTES:

- 1) For reference only, several factors apply.
- 2) Emergency systems are not UL classified for field installation.

Ⓢ Initial lumen output. Will reduce to no less than ~65% of total lumen output.

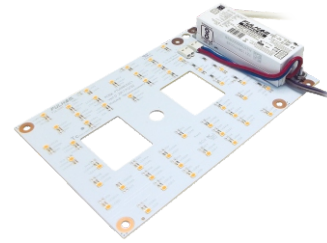
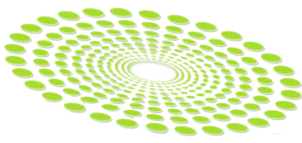

AKMUNV008RTxxxA



Wiring Diagram: Standard Option

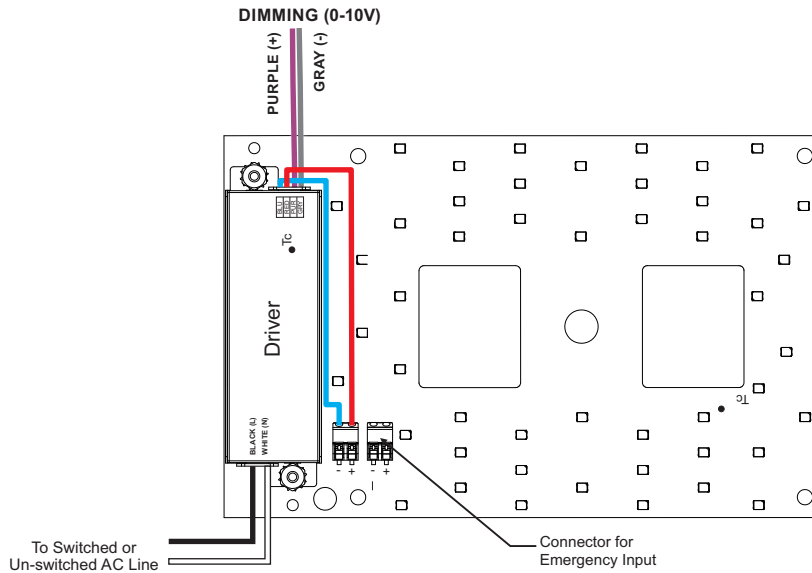

Wiring Diagram: HotSpot2 (FHS2) EM- Pass Through (Recommended for non-Fulham LED EM)

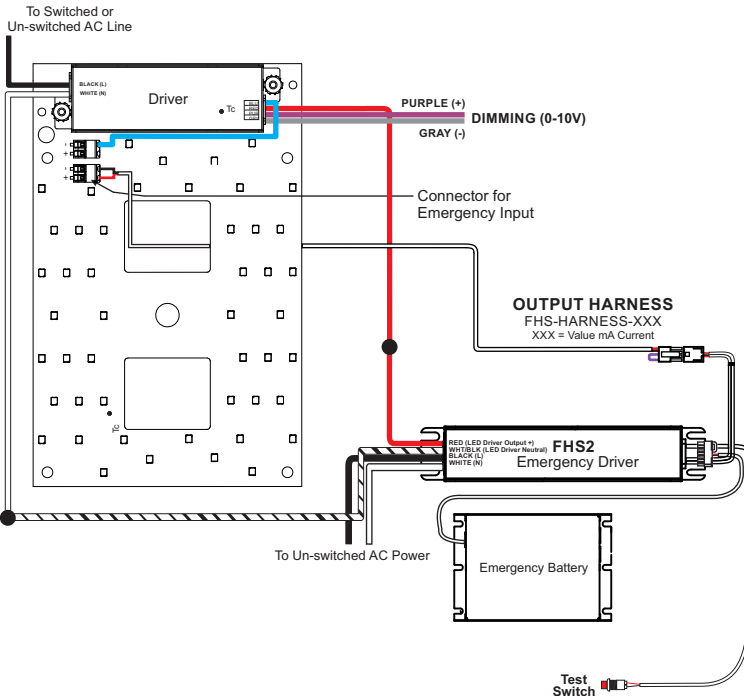

Wiring Diagram: HotSpot2 (FHS2) EM- In Parallel (Recommended for Fulham LED EM)

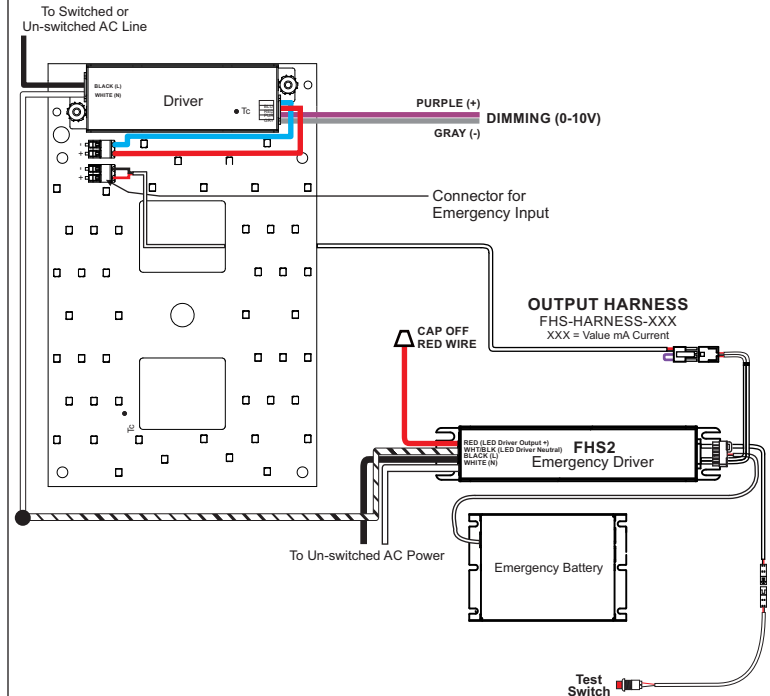

NOTES:

- 1) For reference only, several factors apply.
- 2) Emergency systems are not UL classified for field installation.

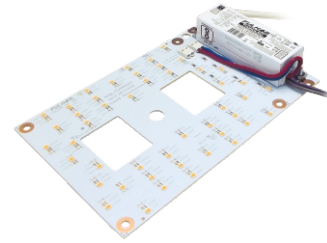
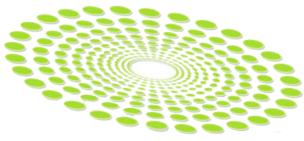

AKMUNV008RTxxxA



Wiring Diagram: Constant Power with conduit (FHSCP) EM- Pass Through (Recommended for non-Fulham LED EM)

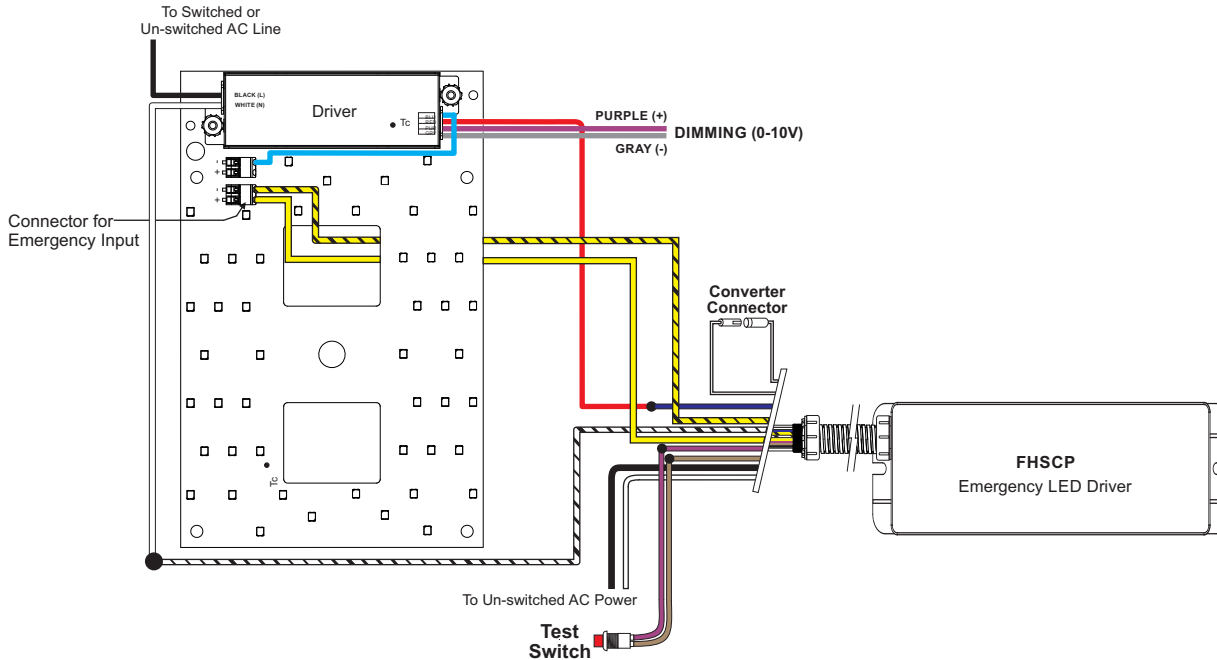

Wiring Diagram: Constant Power with conduit (FHSCP) EM- In Parallel (Recommended for Fulham LED EM)

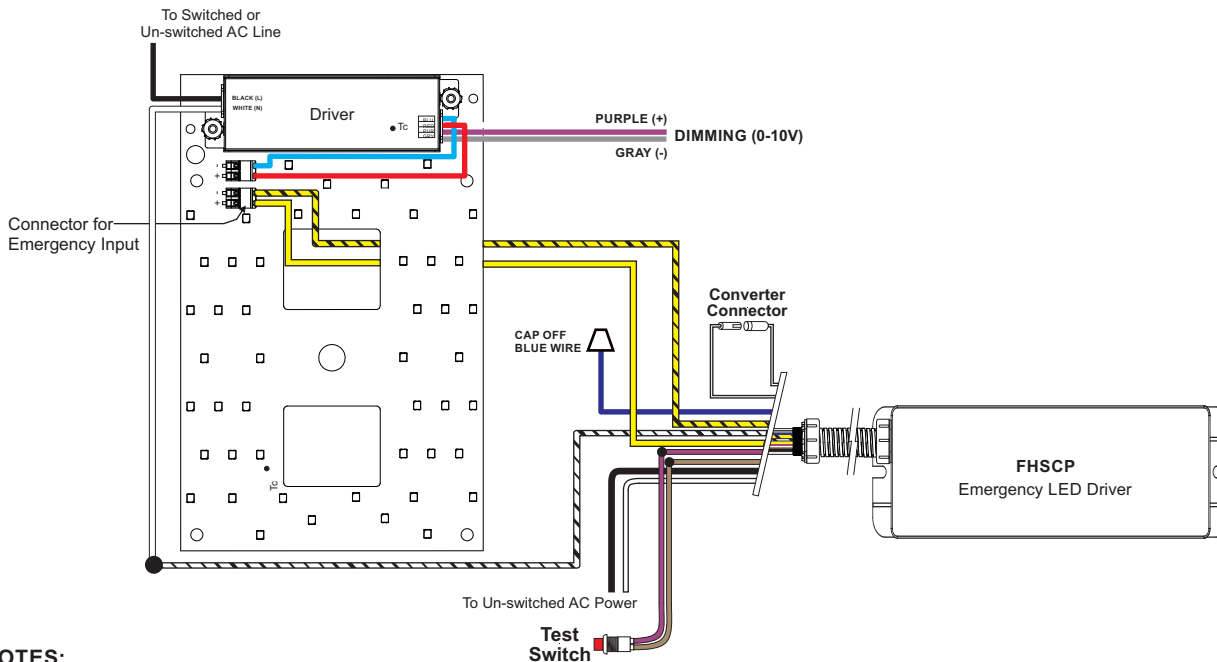

NOTES:

- 1) For reference only, several factors apply.
- 2) Emergency systems are not UL classified for field installation.

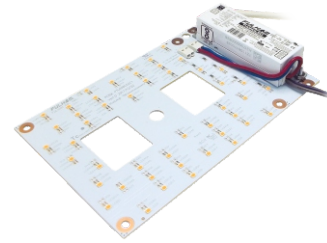
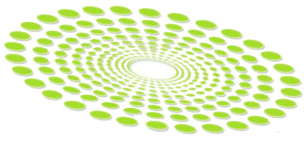

AKMUNV008RTxxxA



Wiring Diagram: Parallel Wiring (FHSCP-UNV-10P-L-SD)

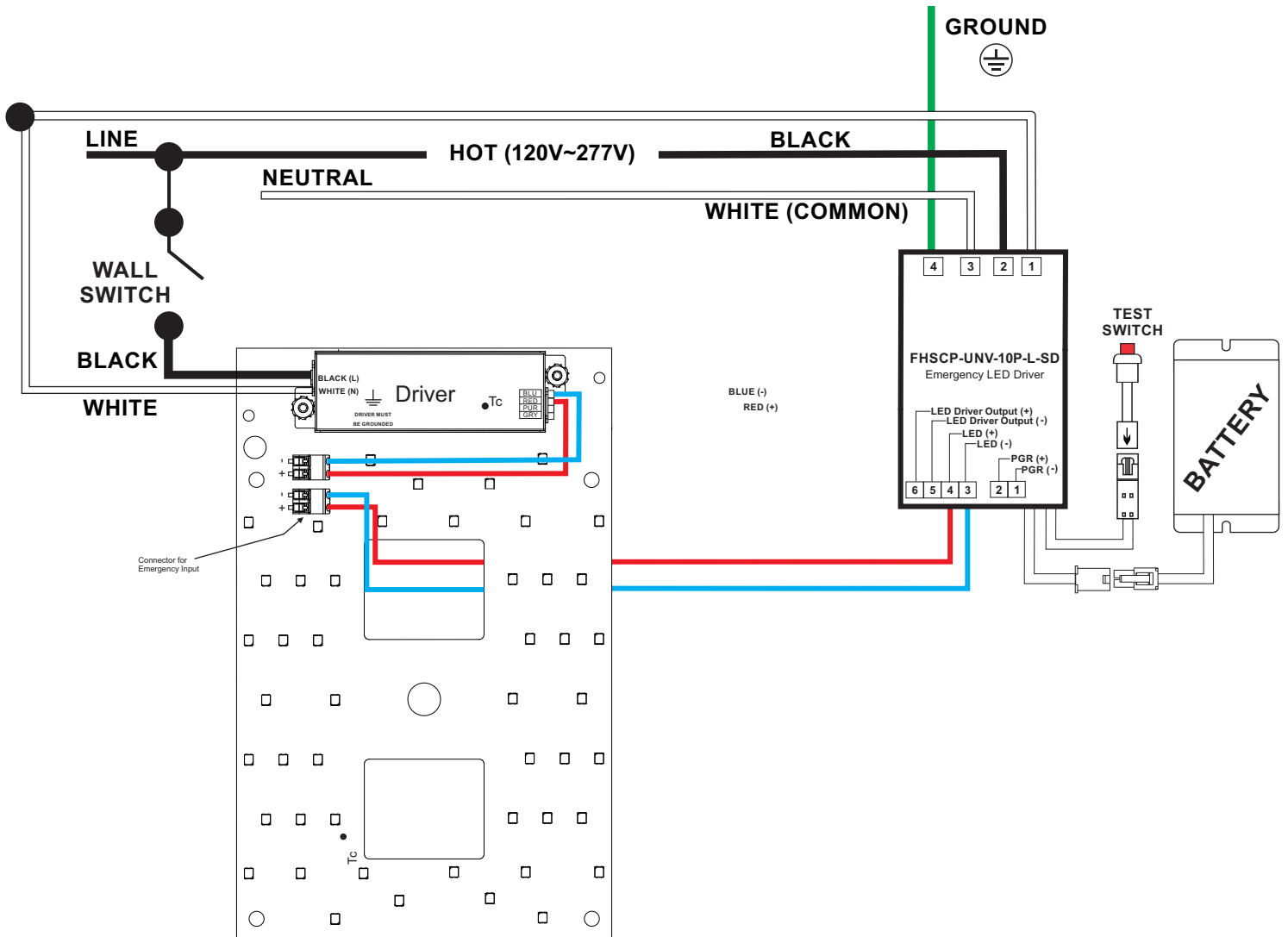

NOTES:

- 1) For reference only, several factors apply.
- 2) Emergency systems are not UL classified for field installation.

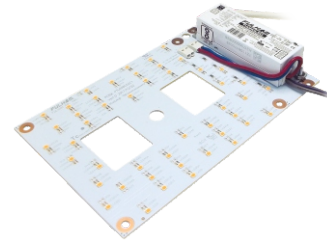
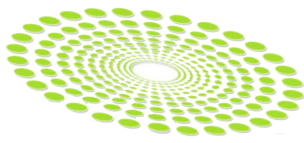

AKMUNV008RTxxxA



Color and Binning

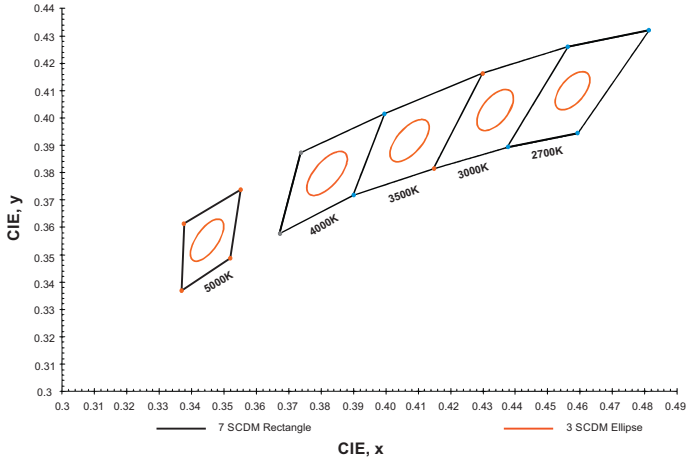

Optical Spectrum

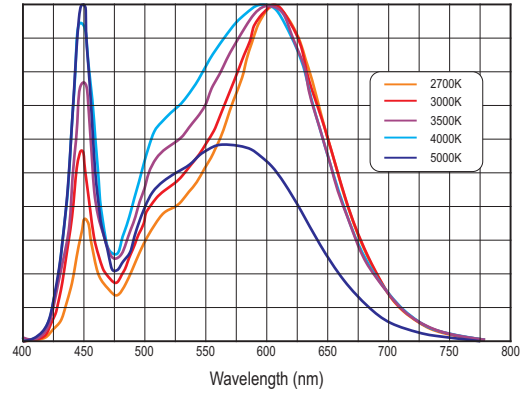

NOTES:

- 1) The Color and Binning and Optical Spectrum charts are for reference only. For more detailed info, contact factory.
- 2) Reference Samsung Chromaticity Diagram for Color and Binning. Binning per ANSI C78.377-2015 @ 25°C; 3 SDCM.
- 3) The Optical Spectrum values vary depending on product type and color rank.

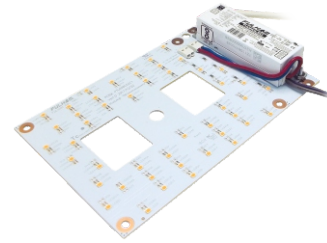
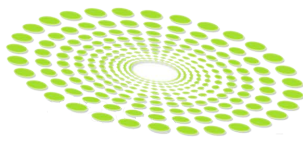

AKMUNV008RTxxxA



Guidelines

Termination Notes

- A luminaire disconnect UL listed connector is included, as part of DC Engine Retrofit Kit to meet Energy Star requirements.
- Use solid wire size 18AWG/12" per pole, rated at max 600V load and 105°C operating temperature.
- Strip wires to 11-13mm (0.47in.).
- Connector not for multiple use.
- For additional information on Wago's 873 Series Lumi-Nuts® connector, please visit:



Environmental Rating

- DC Engine Retrofit Kit are rated for dry and damp locations.

Fastening to Luminaire

- When installing by "mounting thru holes" (recommended), use any screw with diameter less than 0.13in. [3.4mm]. Mount on a flat surface and use all 4 mounting holes to ensure good contact between back side of DC Engine Retrofit Kit and mounting surface. Refer to max specified torque for installation. Suggested screw sizes: #5 or M3 Pan Head screw.

Electrostatic Sensitive Product (ESD)

- Fulham LED products should be handled with proper measures to protect against any potential ESD damage.
- When servicing, personnel should be ground and direct contact with LED should be avoided.

Thermal Management

- Proper thermal management should be employed to ensure life and reliability of product.

Wiring

- Intended for UNV (120-277V) application ONLY.
- Connect the Black wire from the DC Engine Retrofit Kit to the building Line by using the proper connectors or wire nuts.
- Connect the White wire from the DC Engine Retrofit Kit to the building/source Neutral by using the proper connectors or wire nuts.
- DC Engine Retrofit Kit and luminaire must be grounded.