



LED Area Light

Platinum Series



Platinum Series

Beyond LED Technology's Platinum Series Area light is the newest, advanced and most feature rich product of its kind. Our Platinum light offers tool-less serviceability and high lumens per watt for maximum power savings and rebates from power companies.

- High Efficiency LumiLEDs 5050 LEDs
- Ultra thin sleek design
- Up to 170 lumens per watt
- The Most reliable Meanwell HLG Series Driver
- Optional 3 Pin Screw-in photo cell and optional U-Bracket mount
- Built-in 10KV Surge protector
- Tool-less and one man serviceability
- Built-in universal bracket fits most applications
- Heat resistant polycarbonate optical lens
- Die Cast Aluminum housing
- Universal 100-277Vac / 480Vac optional
- Compatible with most controls
- DLC Approved & 5 year warranty
- Available in Bronze Housing

LED Area Light

Platinum Series

LED AREA LIGHTS	
SKU #	151089
MODEL #	BLT-S-GB-120WA50T3B1

Specifications

CONSUMPTION	120W
COLOR TEMPERATURE	5000K
LUMEN	20400Lm
CRI	>70
POWER FACTOR	> 0.9

Fixture Specifications

IP RATING	IP65
LIFE SPAN	50,000 Hours
HOUSING	Bronze/Aluminum

CORRELATED
COLOR TEMPERATURE
(CCT)

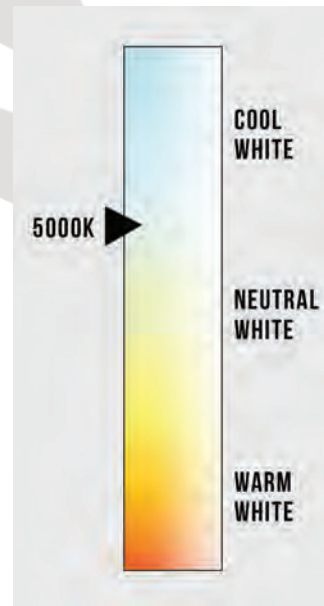

Others

OPERATING TEMPERATURE	APPLICATION
-4°F TO 122°F	Indoor / Outdoor

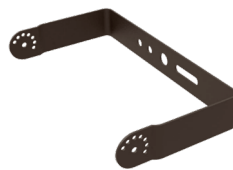

Optional
U-Bracket
mount

Warranty & Qualification

WARRANTY	UL & DLC Listed
5 Year Limited	Yes

LED Area Light

Platinum Series

Dimensions

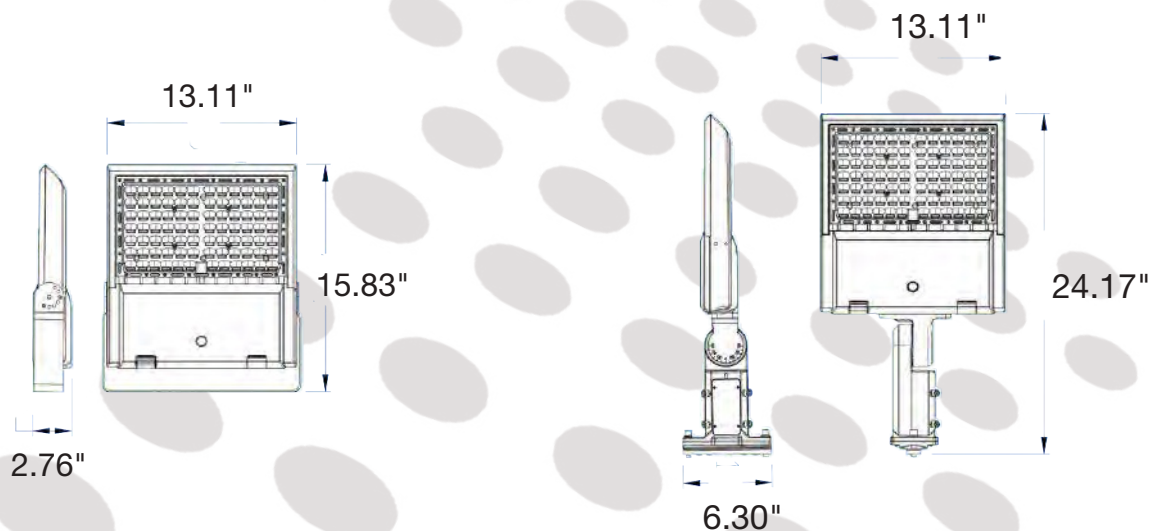

Packaging

Tolerance of Carton Size: ± 0.590551 in, Tolerance of Weight: $\pm 10\%$.

Model	Pcs/Box	Dimensions	Weight	Pallet Quantity	Pallet Weight	Pallet Dimensions
120W w/Universal Bracket	1	25" X 16" X 7"	18 Lb			

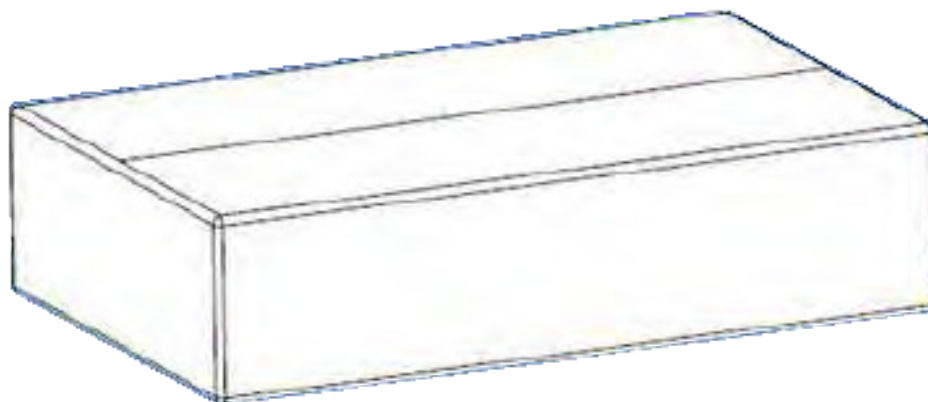

LED Area Light Platinum Series

Instructions

Cautions:

1. Can not use the electric generator to test the LED lamp.
2. Please abide by related country, regional and local law and regulations when install this fixture.
3. To avoid electrical shock and damage, please do not install the lights on rainy days.

Notices:

1. To prevent from electric shock or fire risk, the installation must be conducted by an operator who has professional electrical knowledge.
2. Please wear gloves to avoid injury before installing lamps.
3. During or after installation, if there are situations such as smoke, fire in the wires or lamps, please turn off the power immediately and notify relevant personnel of an overhaul.
4. This light can be used for outdoor installation.

Instructions:

1. This product has dimming and non-dimming function, which differs in installation ways.
2. 3 dimming functions are available in this area light:
 - (1). Constant current can be achieved by 1-10VDC dimming.
 - (2). PWM signal dimming.
 - (3). Variation of resistance unit dimming (Please choose the appropriate dimming way according to your needs. You can also choose not to use this function).
3. Choose the wire connection ways, dimming ways and installation ways according to your needs and the led fixture purchased.

Wiring Diagram:

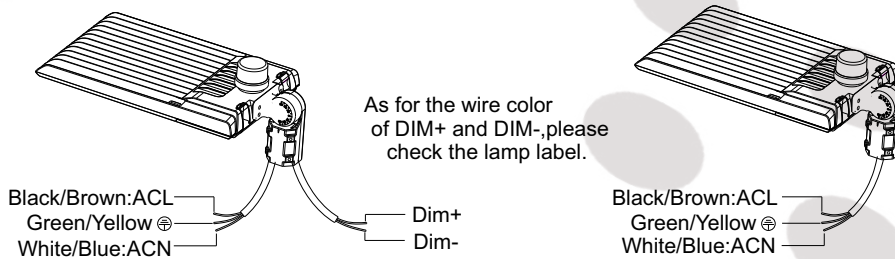

Optional Brackets and Installation Instructions

There are 2 optional brackets for this fixture. The following is area light fixtures with different brackets.

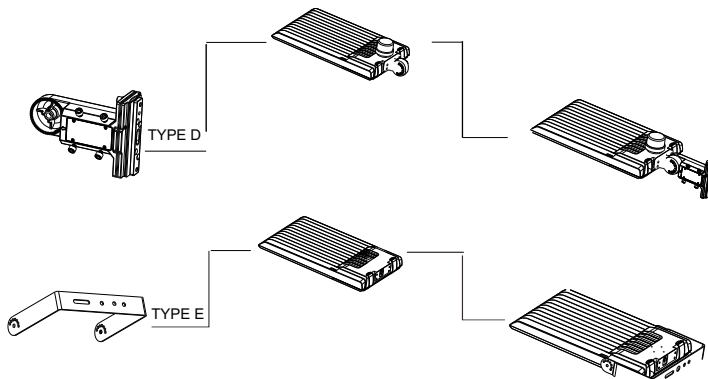

LED Area Light Platinum Series

Instructions

ADJUSTABLE FITTER MOUNTING & DIRECT MOUNTING (TYPE D)

ADJUSTABLE FITTER MOUNTING

Step 1: Remove the spare parts from D bracket. (Figure 17).

Step 2: Loosen the four bolts on D bracket, connect the wires correctly, and pull the wires into the poles. (Figure 18)

Step 3: Place the bracket into the pole and lock the four bolts. (Figure 18)

Notice: Adjustable angle is 0-90° (Figure 18)

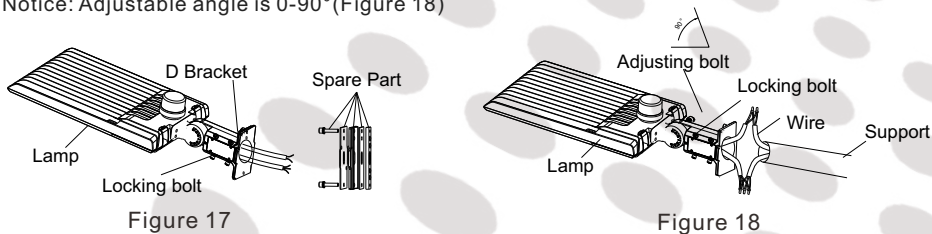

DIRECT MOUNTING

Step 1: Remove the four bolts from D bracket, remove the four rubber plugs from installation bar, put the four rubber plugs on the place where the four bolts were previously placed on the bracket for waterproof purpose (Figure 19)

Step 2: Fix D bracket to square pole with bolt, open the cover of D bracket junction box, pull the wire into bracket junction box, connect the wire properly and cover the junction box. (Figure 20)

Notice: Adjustable angle is 0-90°. (Figure 20)

Same as round pole installation, please remember to use the adapting plate for round pole installation (Figure 21)

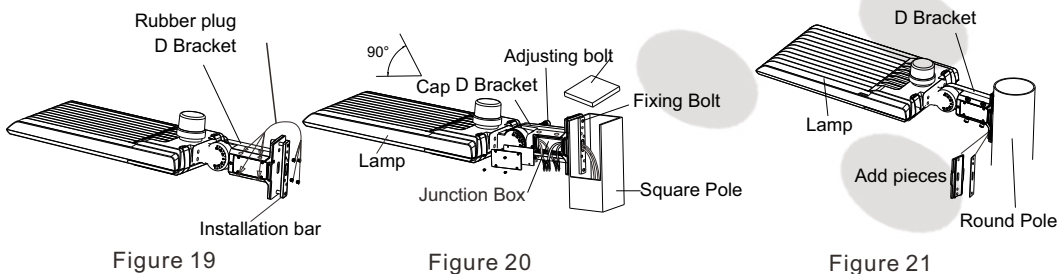

Standard wire:

L/live wire: Black\Brown;

N/null wire: White\Blue;

Ground wire: Green\Yellow-green.

MIN 75 °C SUPPLY CONDUCTOR

THIS PRODUCT MUST BE INSTALLED IN ACCORDANCE WITH THE APPLICABLE INSTALLATION CODE BY A PERSON FAMILIAR WITH THE CONSTRUCTION AND OPERATION OF THE PRODUCT AND THE HAZARDS INVOLVED.

LED Area Light

Platinum Series

Light Distribution Testing Parameters

Luminaire Property

Luminaire Manufacturer:
Voltage: 119.8 V
Power: 121.46 W

Current: 1.0173 A
Power Factor: 0.995

Photometric Results

IES Classification: Type III
Total Rated Lamp Lumens: 19796.4 lm
Efficiency: 100%
Upward Ratio: 1%
Central Intensity: 2817.01 cd
Pos of Max. Intensity: H22.5 V70

Longitudinal Classification: Medium
Measurement Flux: 19796.4 lm
Downward Ratio: 99%
Luminaire Efficacy Rating (LER): 162.99
Max. Intensity: 13778.44 cd

Luminous Intensity Distribution Curve

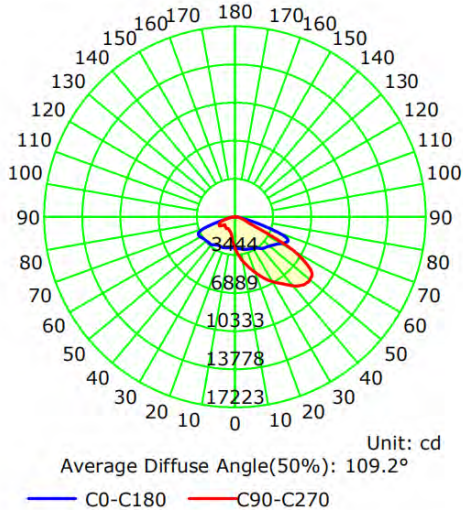

Illuminance at a Distance

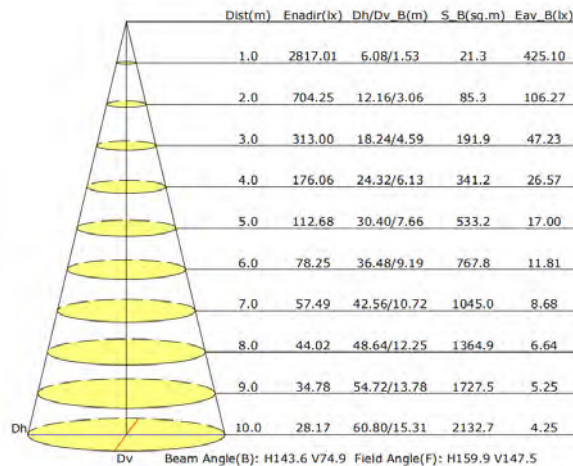

LED Area Light

Platinum Series

User Notice

- Please turn off the power before installing or changing assembly parts.
- The input voltage and lamps should be matching. Before connecting the power line, please make sure the wiring section is insulated.
- Only professionals should install and disassemble the lamps.

Trouble Shooting

- Flickering light - Turn off the power and turn on again in 3 minutes. If the same phenomena occurs, then call Support.
- Not working - Please check all power connections.



LED Area Light

Platinum Series

Application

