



Nothing But LED's Area light is the most economical and newest 2022 model. Our Area light offers high lumens per watt for maximum power savings and rebates from power companies. Our Area light is a perfect solution for lighting parking areas, loading docks and other general lighting applications.

Product Features

- Up to 153 lumens per watt
- Input Voltage 120-277Vac / 277-480V
- High Efficacy LumiLEDs
- Ultra thin sleek design
- Optional Screw-in photocell
- Universal bracket fits most applications
- Several Brackets Options
- Heat resistant polycarbonate optical lens
- Die Cast Aluminum
- UL & DLC Listed
- 5 Year warranty

LED AREA LIGHT



SKU #	Model #	Watt	Lumens	CCT	IP	Housing	Input Voltage	Dimming	Certifications
1550529	BLT-XALH150 W50KT3PADP	150W	22950Lm	5000K	IP65	Bronze	120V-277V	1-10V	UL & DLC
1550528	BLT-XALH310 W50KT3PADP	310W	47430Lm	5000K	IP65	Bronze	120V-277V	1-10V	UL & DLC
1560243	BLT-XALH310 W50KT3PADP	Wattage Adj. 240W/260W/280W/310W	36720Lm 47430Lm	5000K	IP65	Black	120V-277V	1-10V	UL & DLC
1560242	BLT-XALH310 W50KT3PADP	Wattage Adj. 240W/260W/280W/310W	36720Lm 47430Lm	5000K	IP65	Bronze	277V-480V	1-10V	UL & DLC
1560166	BLT-XALH150 W50KT3PADP	Wattage Adj. 100W/120W/150W	15300Lm 22950Lm	5000K	IP65	White	277-480V	1-10V	UL & DLC
1560167	BLT-XALH310 W50KT3PADP	Wattage Adj. 240W/260W/310W	36720Lm 47430Lm	5000K	IP65	White	277-480V	1-10V	UL & DLC

Accessories



Photocell



Shorting Cap

Brackets



SKU: 1550607
Yoke Mount Black



SKU: 1550935
Yoke Mount Bronze



SKU: 1550934
Slip Fitter Bronze



SKU: 1550936
Flexible Straight Arm Bronze



Universal Bracket
Bronze



Universal Bracket
White



Universal Bracket
Black

SKU: 1550529

Specifications

Parameter	Description	Value
General Performance	Model #.	BLT-XALH150W50KT3PADP
	Wattage	150W
	Color Temperature	5000K
	Lumens	Up to 22950LM
	Lumen Efficacy	Up to 153LM/W
	CRI (Ra)	>70
	Distribution Pattern	Type III
	Beam Angle	90° Degree
Electrical	Input Voltage	120-277Vac
	Frequency	50/60Hz
	Dimming	1-10 Dimmable
	PF	≥0.95
	THD	≤20%
	Flicker Percent	Flicker Free
	Driver Brand	Sosen
	Driver Model	SS-150NL-56B
Physical	Driver Surge Protection	10KV Surge Protector
	Operating Temperature	-40°C to 45°C
	Storage Temperature	-40°C - 90°C
	LED Brand	LumiLEDs
	LED Type	SMD2835
	LEDs QTY	216 Pcs
	Housing	Die-Cast Aluminum
Housing Color	Bronze	
Qualification	IP Rating	IP65
	Warranty	5 Year

LED AREA LIGHT



SKU: 1550528

Specifications

Parameter	Description	Value
General Performance	Model #.	BLT-XALH310W50KT3PADP
	Wattage	310W
	Color Temperature	5000K
	Lumens	Up to 47430LM
	Lumen Efficacy	Up to 153LM/W
	CRI (Ra)	>70
	Distribution Pattern	Type III
	Beam Angle	90° Degree
Electrical	Input Voltage	120-277Vac
	Frequency	50/60Hz
	Dimming	1-10 Dimmable
	PF	≥0.95
	THD	≤20%
	Flicker Percent	Flicker Free
	Driver Brand	Sosen
	Driver Model	SS-150NL-56B, 2 pcs
	Driver Surge Protection	10KV Surge Protector
Physical	Operating Temperature	-40° C to 45° C
	Storage Temperature	-40°C - 90°C
	LED Brand	LumiLEDS
	LED Type	SMD2835
	LEDs QTY	432 Pcs
	Housing	Die-Cast Aluminum
Housing Color	Bronze	
Qualification	IP Rating	IP65
	Warranty	5 Year

SKU: 1560166

Specifications

Parameter	Description	Value
General Performance	Model #.	BLT-XALH150W50KT3PADP
	Wattage Adjustable	100W/120W/150W
	Color Temperature	5000K
	Lumens	Up to 15300Lm / 22950LM
	Lumen Efficacy	Up to 153LM/W
	CRI (Ra)	>70
	Distribution Pattern	Type III
	Beam Angle	90° Degree
Electrical	Input Voltage	277-480Vac
	Frequency	50/60Hz
	Dimming	1-10 Dimmable
	PF	≥0.95
	THD	≤20%
	Flicker Percent	Flicker Free
	Driver Brand	Sosen
	Driver Model	SS-150NL-56B, 2 pcs
	Driver Surge Protection	10KV Surge Protector
Physical	Operating Temperature	-40° C to 45° C
	Storage Temperature	-40°C - 90°C
	LED Brand	LumiLEDs
	LED Type	SMD2835
	LEDs QTY	432 Pcs
	Housing	Die-Cast Aluminum
Qualification	Housing Color	White
	IP Rating	IP65
	Warranty	5 Year

LED AREA LIGHT



SKU: 1560243 / 1560242 / 1560167

Specifications

Parameter	Description	Value
General Performance	Wattage Adjustable	240W/260W/280W/310W
	Color Temperature	5000K
	Lumens	Up to 36720LM / 47430LM
	Lumen Efficacy	Up to 153LM/W
	CRI (Ra)	>70
	Distribution Pattern	Type III
	Beam Angle	90° Degree
Electrical	Input Voltage	120-277Vac / 277-480Vac
	Frequency	50/60Hz
	Dimming	1-10 Dimmable
	PF	≥0.95
	THD	≤20%
	Flicker Percent	Flicker Free
	Driver Brand	Sosen
	Driver Model	SS-150NL-56B, 2 pcs
	Driver Surge Protection	10KV Surge Protector
Physical	Operating Temperature	-40° C to 45° C
	Storage Temperature	-40°C - 90°C
	LED Brand	LumiLEDS
	LED Type	SMD2835
	LEDs QTY	432 Pcs
	Housing	Die-Cast Aluminum
	Housing Color	Bronze / Black / White
Qualification	IP Rating	IP65
	Warranty	5 Year

LED AREA LIGHT

Correlated Color Temperature (CCT)

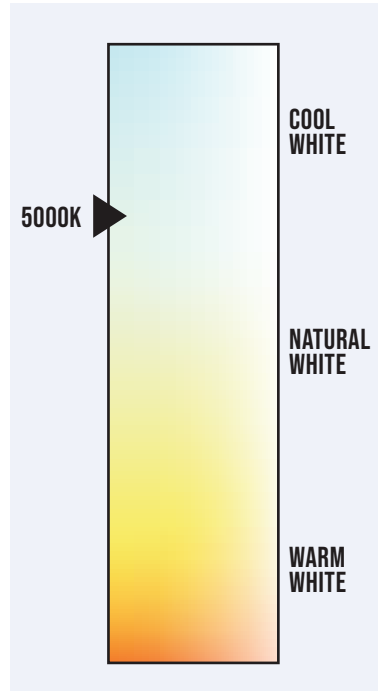

Dimension

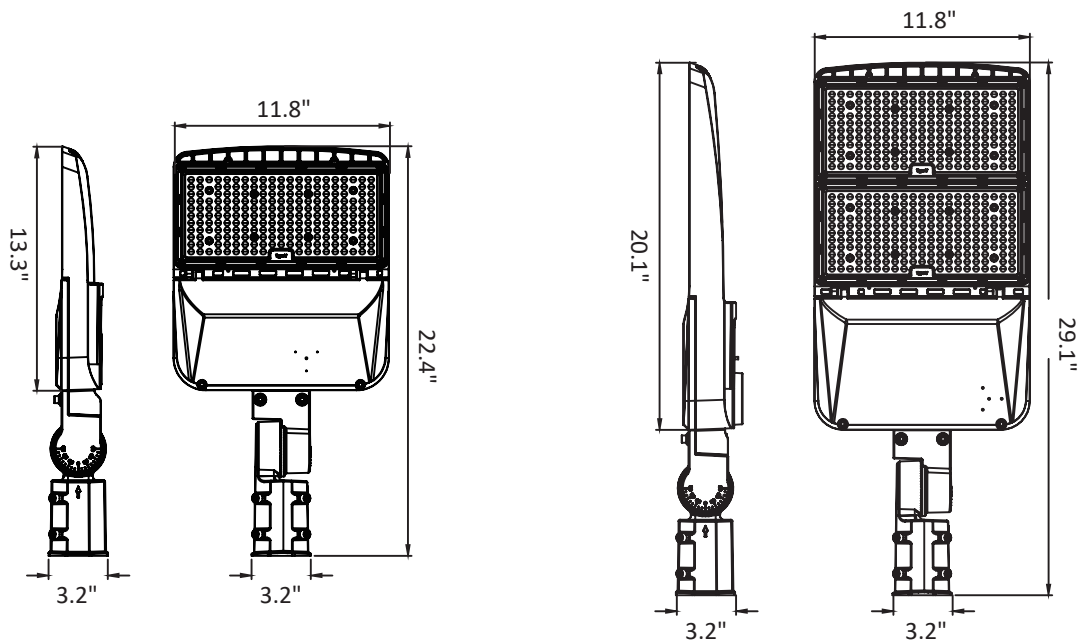

SKU: 1550529 Photometric Test Result

Test Condition:

Test Ambient (°C)	Test Humidity (%)	Orientation	Stabilization Time (minute)	Test Time (minute)
25.0	43.6	Face Down	90	25

Electrical Data:

Voltage (V)	Frequency (Hz)	Current (A)	Wattage (W)	Power Factor
120.0	60	1.2361	148.17	0.9989

Goniophotometer Data:

Parameter	Results
Total Luminous (lm)	23129.6
Luminous Efficacy (lm/W)	156.10
Zonal Lumens Distribution (0-90°)	99.9%
Zonal Lumens Distribution (80-90°)	1.7%
Beam Angle (°)	90.8
BUG	B3-U2-G3

Luminous Intensity Distribution Diagram:

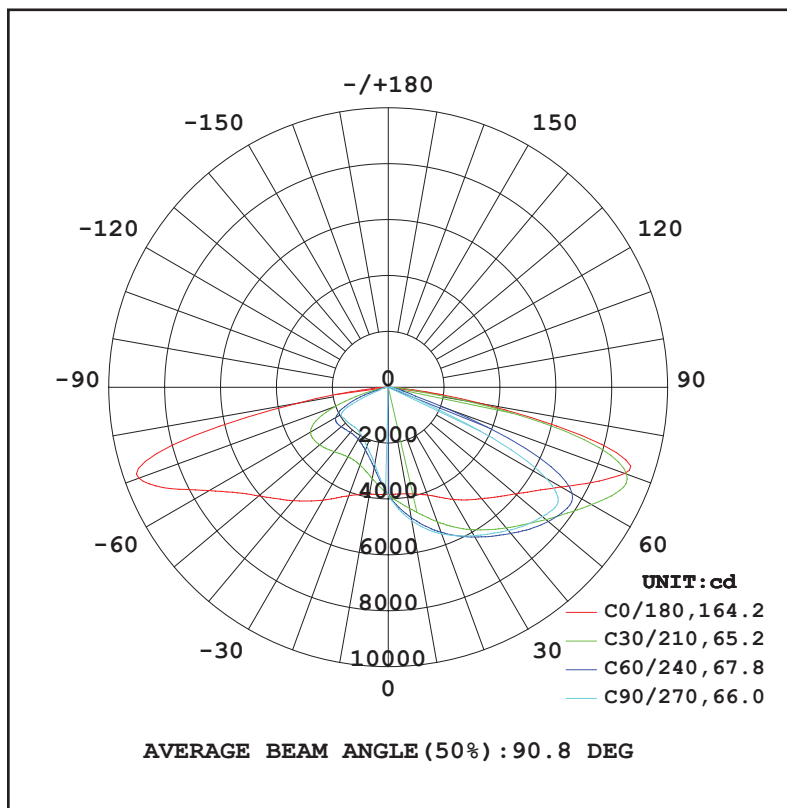

SKU: 1550528

Photometric Test Result

Test Condition:

Test Ambient (°C)	Test Humidity (%)	Orientation	Stabilization Time (minute)	Test Time (minute)
25.1	44.3	Face Down	90	25

Electrical Data:

Voltage (V)	Frequency (Hz)	Current (A)	Wattage (W)	Power Factor
120.0	60	2.5476	305.34	0.9988

Goniophotometer Data:

Parameter	Results
Total Luminous (lm)	46689.2
Luminous Efficacy (lm/W)	152.91
Zonal Lumens Distribution (0-90°)	99.9%
Zonal Lumens Distribution (80-90°)	1.7%
Beam Angle (°)	91.3
BUG	B4-U2-G4

Luminous Intensity Distribution Diagram:

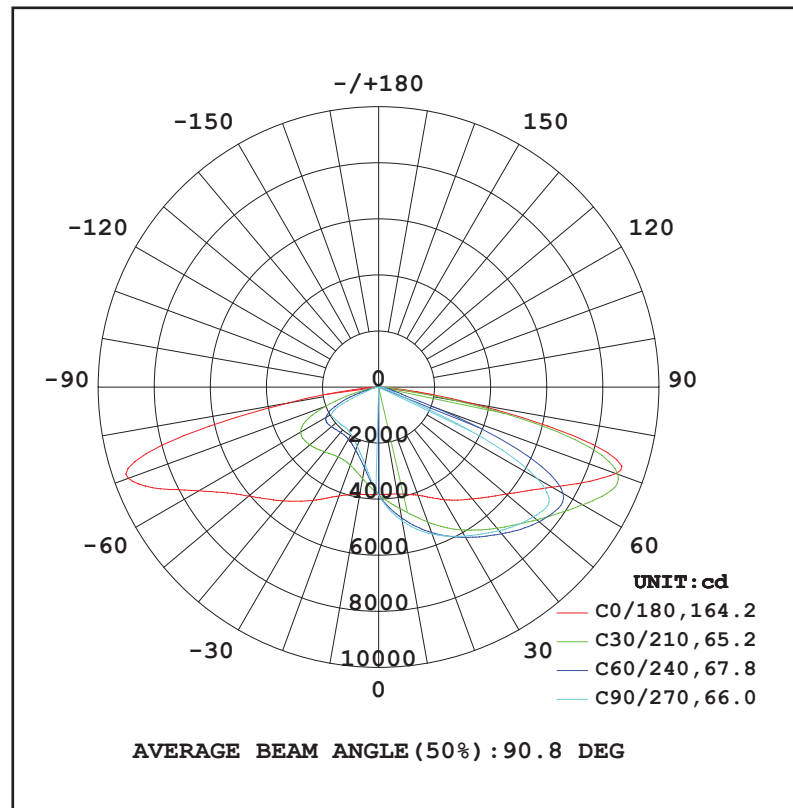

SKU: 1560166

Photometric Test Result

Test Condition:

Test Ambient (°C)	Test Humidity (%)	Orientation	Stabilization Time (minute)	Test Time (minute)
25.0	47.8	Face Down	90	25

Electrical Data:

Voltage (V)	Frequency (Hz)	Current (A)	Wattage (W)	Power Factor
277.0	60	0.5257	145.40	0.9985

Goniophotometer Data:

Parameter	Results
Total Luminous (lm)	20580.6
Luminous Efficacy (lm/W)	141.54
Zonal Lumens Distribution (0-90°)	99.9%
Zonal Lumens Distribution (80-90°)	1.6%
Beam Angle (°)	88.6
BUG	B3-U2-G3

Luminous Intensity Distribution Diagram:

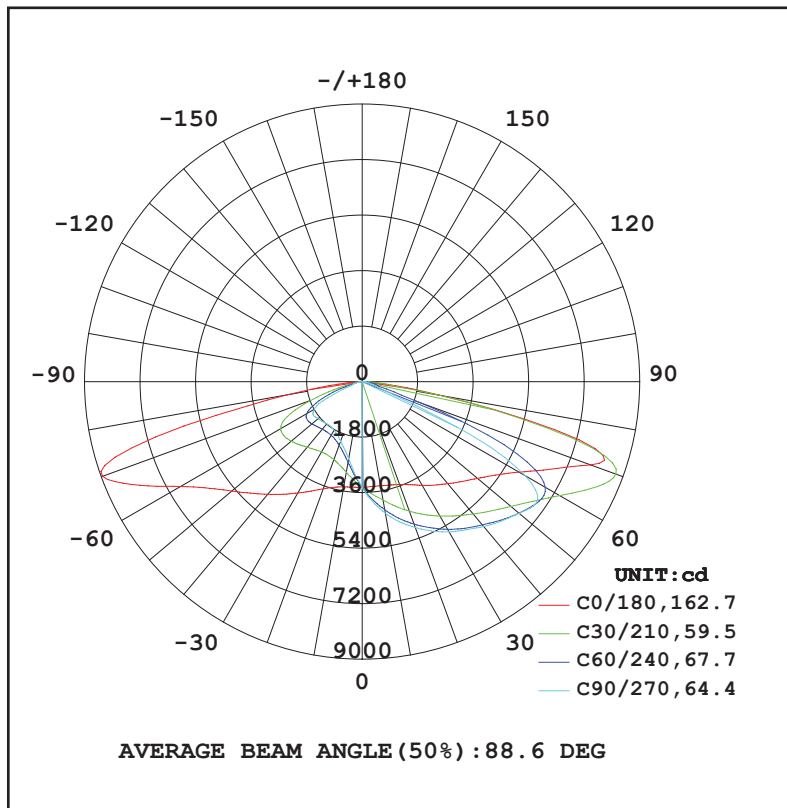

SKU: 1560167

Photometric Test Result

Test Condition:

Test Ambient (°C)	Test Humidity (%)	Orientation	Stabilization Time (minute)	Test Time (minute)
25.1	44.3	Face Down	90	25

Electrical Data:

Voltage (V)	Frequency (Hz)	Current (A)	Wattage (W)	Power Factor
277.0	60	1.1627	319.14	0.9909

Goniophotometer Data:

Parameter	Results
Total Luminous (lm)	44168.9
Luminous Efficacy (lm/W)	138.40
Zonal Lumens Distribution (0-90°)	99.9%
Zonal Lumens Distribution (80-90°)	1.4%
Beam Angle (°)	91.3
BUG	B4-U2-G4

Luminous Intensity Distribution Diagram:

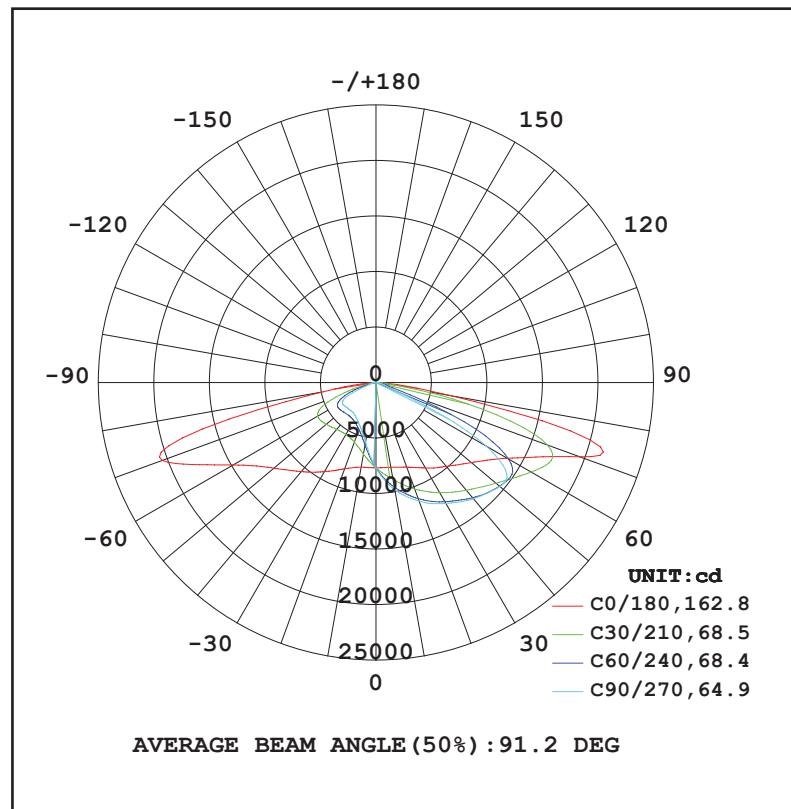

Installation

Please read this manual carefully before using the product

Application

Widely used in Indoor and outdoor • Parking lot • Stadiums • General road lighting • Residential area • Yard park • Petrol station

Notes before Installation

1. Be careful to open the carton, contact us if any damage.
2. This product must be installed in accordance with the applicable installation, code by a person familiar with the construction and operation of the product and the hazards involved.
3. "caution - risk of shock" and "disconnect power before servicing" when photoelectric switch provided.
4. Please check whether the voltage marked on the luminaire is consistent with the input voltage to be connected, so as not to damage the LED luminaire.
5. To ensure the lifetime of the product, please do not use it in a place with strong acid mist.
6. Make sure the installation position can withstand 10 times the weight of the luminaire before installation and install it at a flat place without vibration, no swing, no fire hazard.

Overview Description



Installation instructions

ALWAYS TURN OFF THE POWER SUPPLY FROM MAIN CIRCUIT BREAKER FIRST!

• Type A (Slip Fitter)

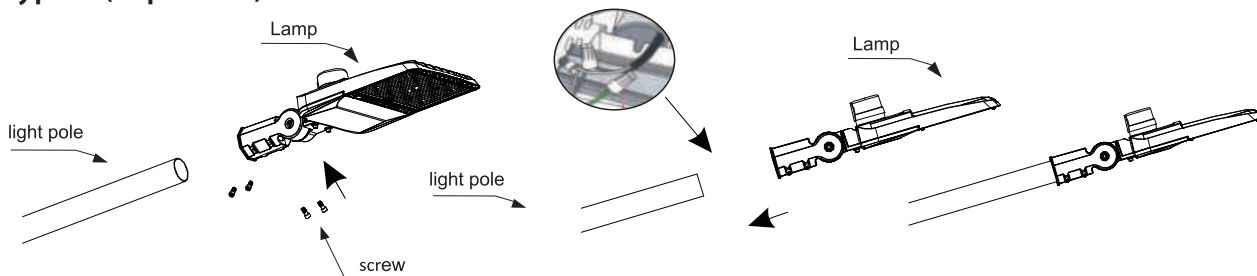

1. Attach the lamp arm to the lamp first

2. Connect the input wire and install the lamp on the lamp post
Note: after lengthening the input wire, meet the height requirement of the light pole and connect the wire at the bottom of the light pole.

Installation

Please read this manual carefully before using the product

• Type B (Yoke Mount)

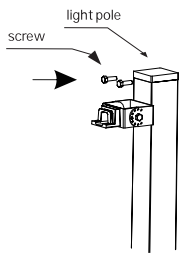

1. First install the lamp arm in the proper position of the lamp pole

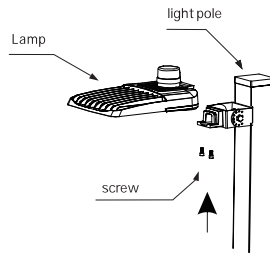

2. Install the light fixture on the lamp arm

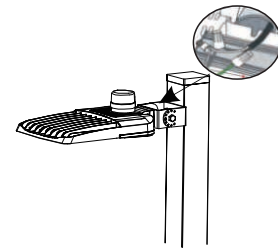

A lower cover of the lamp arm is opened and complete wiring at hand hole on pole. Use suitable listed water proof cord bushing and outlet box cover.

• Type C (Straight Mount)

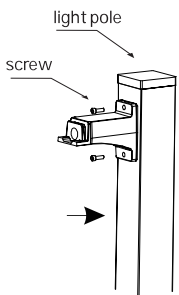

1. First install the lamp arm in the proper position of the lamp pole

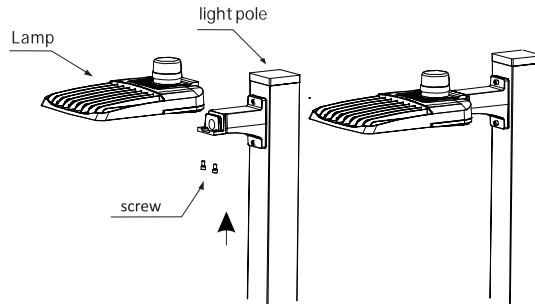

2. Install the light fixture on the lamp arm

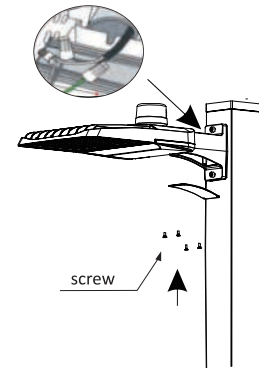

A lower cover of the lamp arm is opened and complete wiring at hand hole on pole. Use suitable listed water proof cord bushing and outlet box cover

• Wiring Diagram

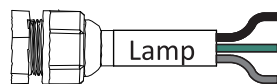

L-black
GND-green
N-white

Shipping and Warehousing

1. Please do not shake it too much during transportation, handle carefully when unloading.
2. Recommended to be stored in a warehouse of -10 - +60 °C and keep the warehouse dry.

Trouble shooting

PROBLEM	POSSIBLE CAUSE	SOLUTION
Light will not come on	A. Light switch is turned off. B. Fuse is blown or circuit breaker is turned off. C. Incorrect circuit wiring.	A. Turn light switch on. B. Replace fuse or turn circuit breaker on. C. Verify that fixture is wired properly.

LED AREA LIGHT



Packaging

Wattage	Carton Size	Qty	Net Weight	Gross Weight
Wattage Adj. 100W/120W/150W	15.59x13.07x5.23	1	7.5 LBS	11.9 LBS
Wattage Adj. 240W/260W/280W/310W	22.32x13.07x5.70	1	11.0 LBS	13.8 LBS

Application



Warranty

5 Year warranty