



We are the leader in cutting-edge refrigerated display lighting technology! Our V-Shape cooler light produces a wider beam for more evenly dispersed lighting. Also, our LED Cooler lights have a built-in driver and a daisy-chain design that allows it to be installed in minutes. Our LED Cooler/Freezer lights qualify for rebate programs with most major power companies. Our Cooler light and Freezer Lamps deliver crisp, bright light that creates attractive food and product displays in freezers and walk-in refrigerator cases. They consume less energy and run longer and cooler than fluorescent freezer bulbs, lowering operating costs and reducing the risk of food spoilage.

- Up to 130 lumens per watt
- V Shape Design
- Wider beam angle
- Universal 100-277Vac 50-60Hz
- Built-in driver
- Daisy-chain (up to 10 lamps in a series).
- ETL Listed
- CRI >80

LED COOLER LIGHT



V Shape

SKU #	Model #	Watts	Lumens	CCT	Length	Type	Certifications
1500015	BLTCL25W60IN5K	25W	2900Lm	5000K	60"	V-Shape	ETL & DLC
1500014	BLTCL25W60IN65K	25W	3000Lm	6500K	60"	V-Shape	ETL
1500013	BLTCL28W69IN5K	28W	3500Lm	5000K	69"	V-Shape	ETL & DLC
1500012	BLTCL28W69IN65K	28W	3360Lm	6500K	69"	V-Shape	ETL

Dimensions

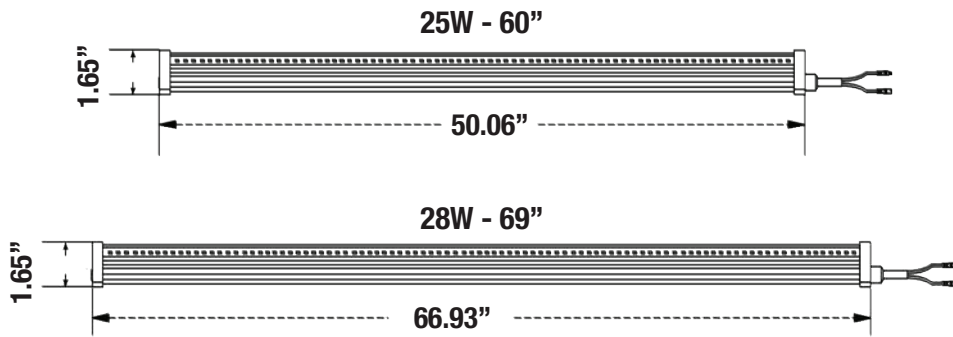

CORRELATED COLOR TEMPERATURE (CCT)

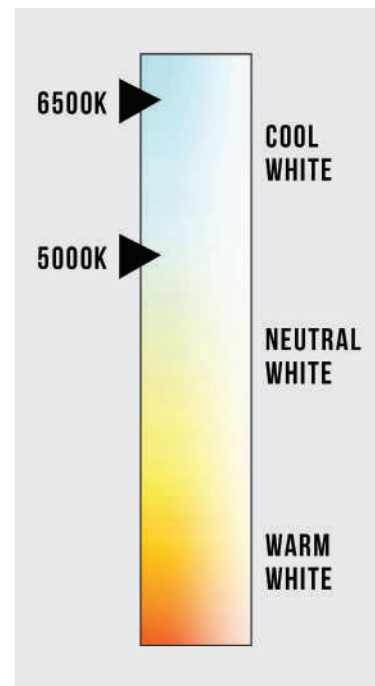

Connect Up to 10 lamps in a series

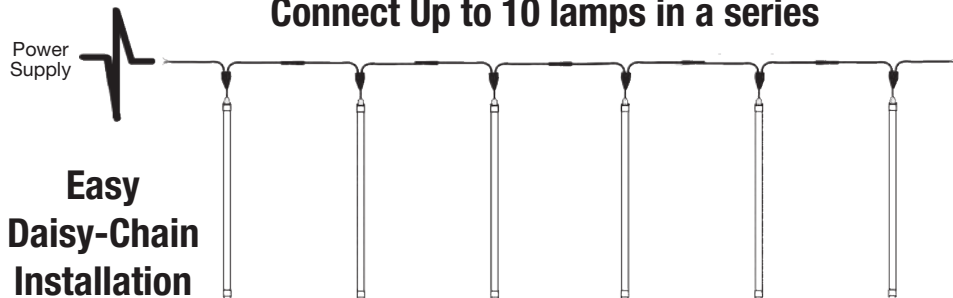

Easy Daisy-Chain Installation

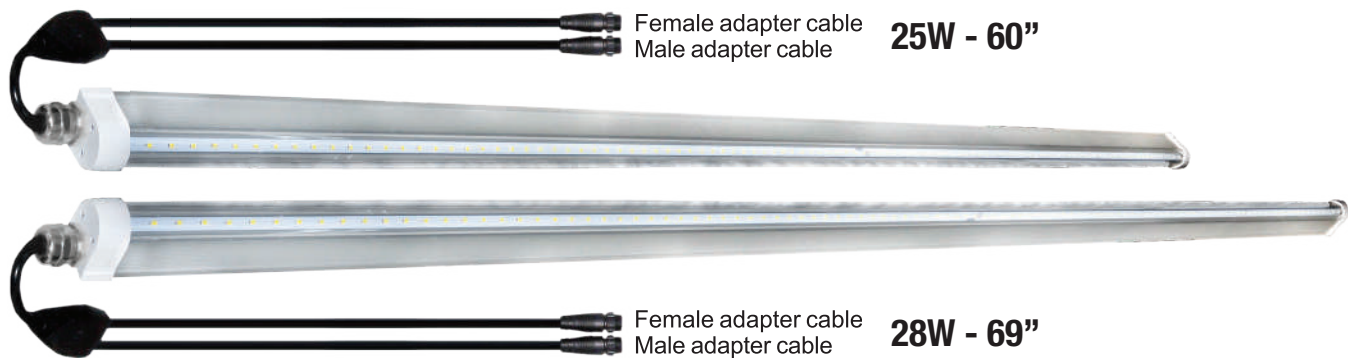

Specifications

POWER:	25W	25W	28W	28W
Size:	60"	60"	69"	69"
LED Quantity:	192Pcs	192Pcs	216Pcs	216Pcs
Lumens:	2900Lm	3000Lm	3500Lm	3360Lm
Color Range:	5000K	6500K	5000K	6500K
Housing:	AL and High strength PC			
Operation Temperature:	-4°F to 104°F			
Life Span:	50,000hours			
Voltage range:	AC100-277V			
Frequency:	50/60Hz			
Beam angle:	180°			
PC Lens:	Clear			
Color index (CRI):	>80			
Luminous efficacy:	120lm/w			
PF:	≥0.92			
Power Efficiency:	≥0.88			

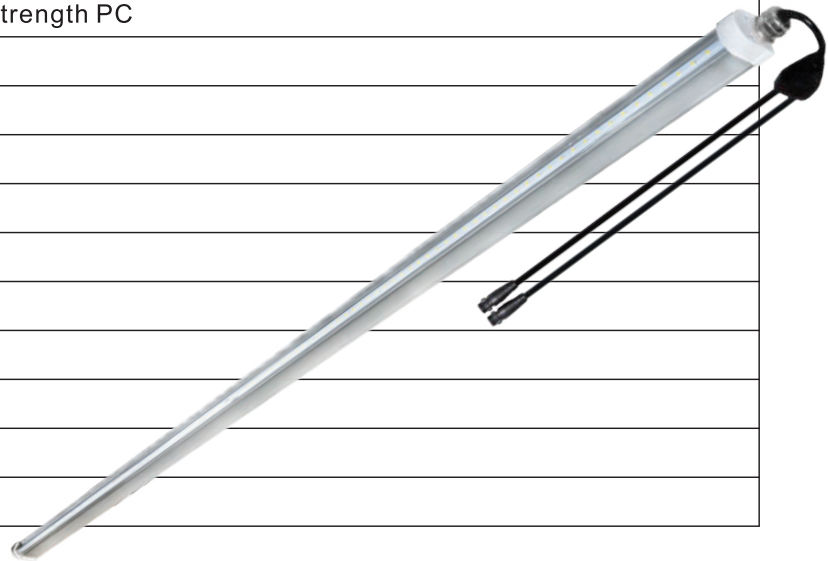

Packing

Model	Size	Pcs/Box	Dimensions	Weight	Pallet Quantity	Pallet Weight	Pallet Dimensions
25W	60"	20	71" X 8" X 10"	56 Lbs			
28W	69"	20	79" X 8" X 10"	60 Lbs			

LED Tube

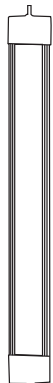

Into Inner Box

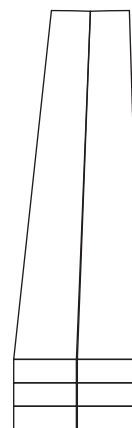
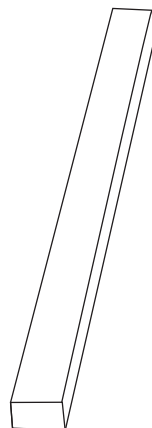
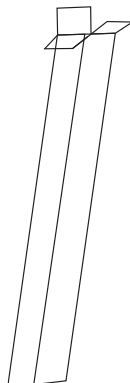

Into Outer Box

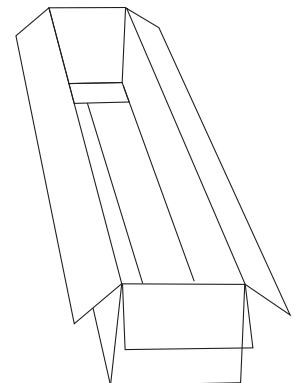

LED COOLER LIGHT



Installation



Mounting hardware required for some cooler lights. Others have built-in brackets.

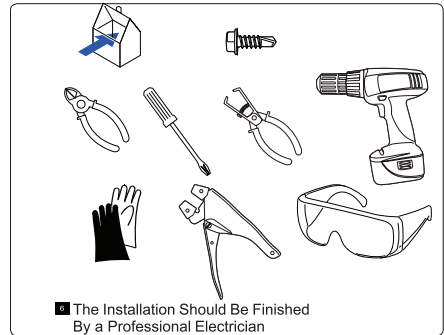
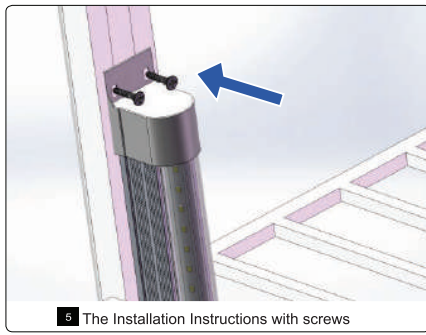
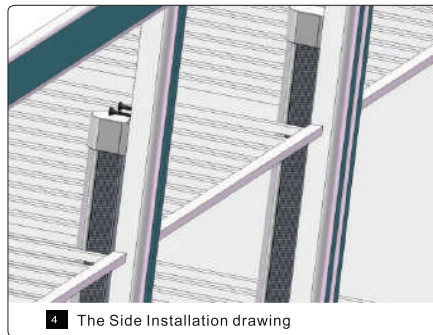
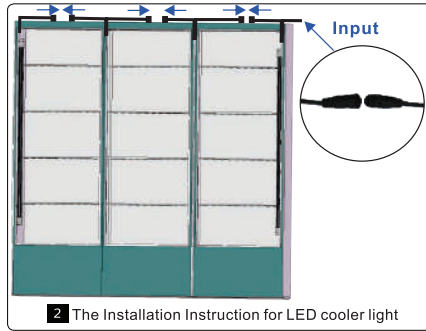
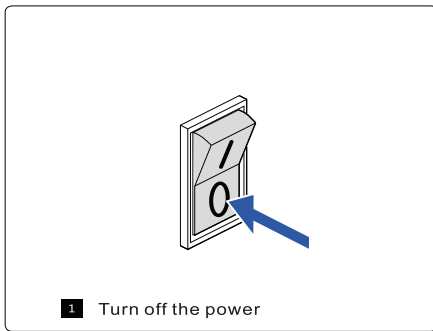

Easy Daisy-Chain Installation



One power source can connect up to ten (10) lights.
WARNING: Do not connect more than ten (10) lights per power source.

Watt Comparison

Beyond LED's Cooler Light	REPLACES	Traditional Cooler Light
25W		50W
28W		55W

Installation

1. Disconnect power from cooler system.

For safety, all power **MUST** be disconnected prior to removal of existing lamps and installation of T8 LED light tubes.

WARNING: Failure to disconnect power could result in serious injury or death. It is the end user's responsibility to consult a licensed electrician and check all local building codes before installation.

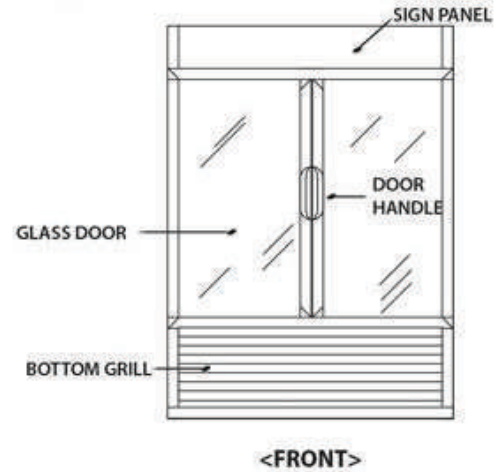

2. Remove existing lamps.

Remove lamp covers if present and remove lamps. Your new T8 lights are shatter-proof; you will no longer require lamp covers.

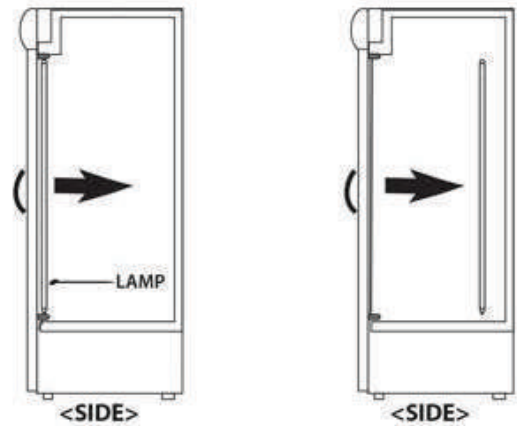

3. Disconnect ballast.

Disconnect wiring from the power source. Ballast removal is optional. Disconnect wiring to original lamp sockets and tie off. None of the existing system will be used, so removal is optional.

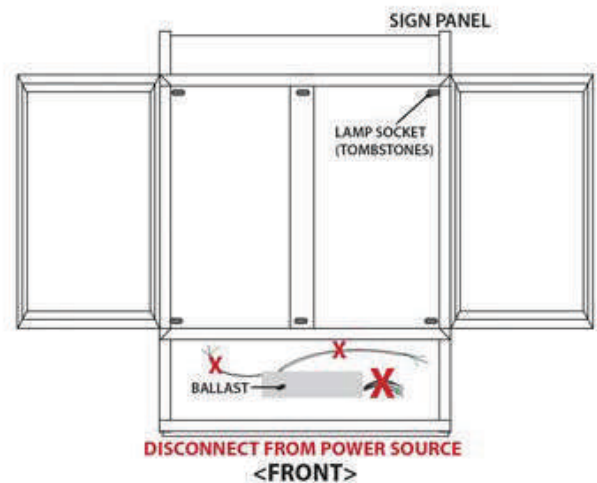

Installation

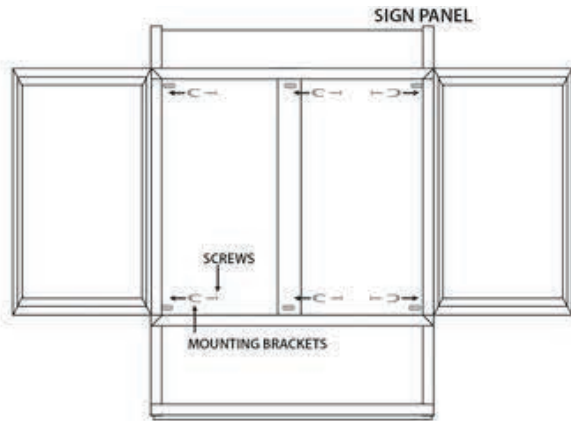

<FRONT>

Installing with mounting brackets

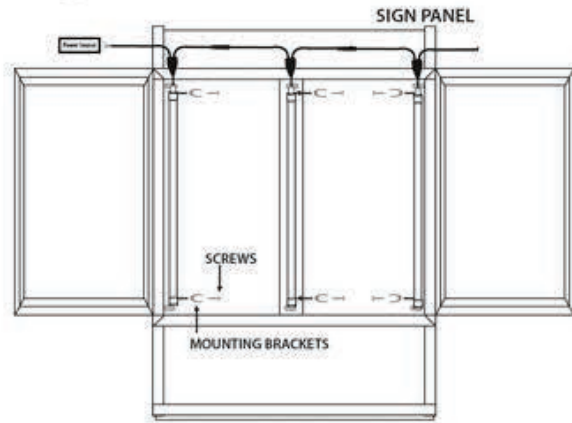

<FRONT>

Installing with built-in brackets

4. Install brackets.

Use self-tapping screws to mount the brackets. In some cases drilling a pilot hole will make the installation easier. Each mounting bracket can be placed inside of the existing sockets (tombstones).



5. Connect to power source and connect lights in a series.

Connect first cable to the power source. Expose 3 wires to connect. See legend above for connection. Connect the male/female ends of each light. (Not to exceed 10 lights).

Distribution Diagram - 25W

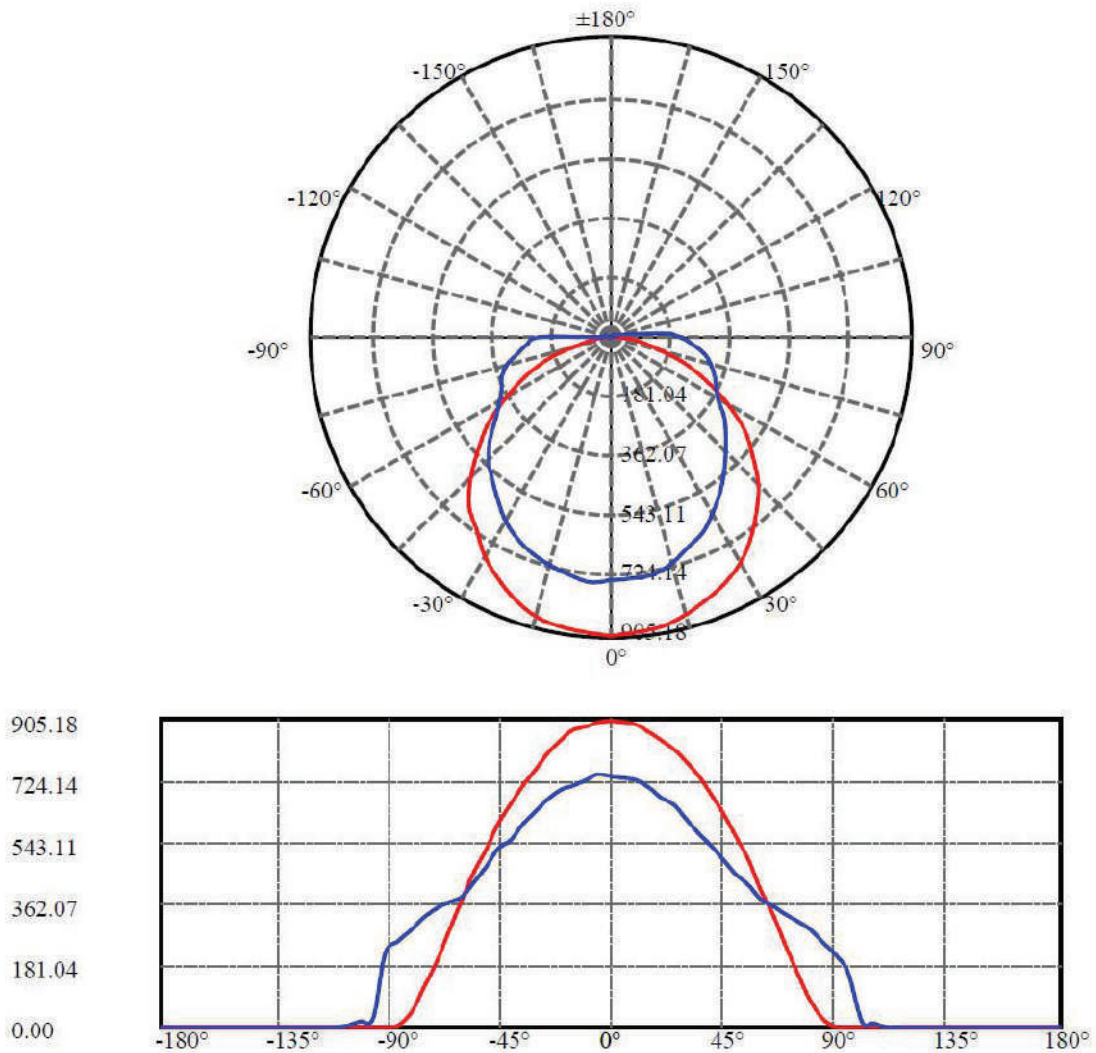

C0/C180: ———

C90/C270: ———

Field angle(10%Imax):C0/180Left:76.9 Right:79.4

:C90/270Left:88.8 Right:102.9

Beam Angle(50%Imax):C0/180Left:55.0 Right:57.5

:C90/270Left:58.2 Right:66.1

Distribution Diagram - 25W

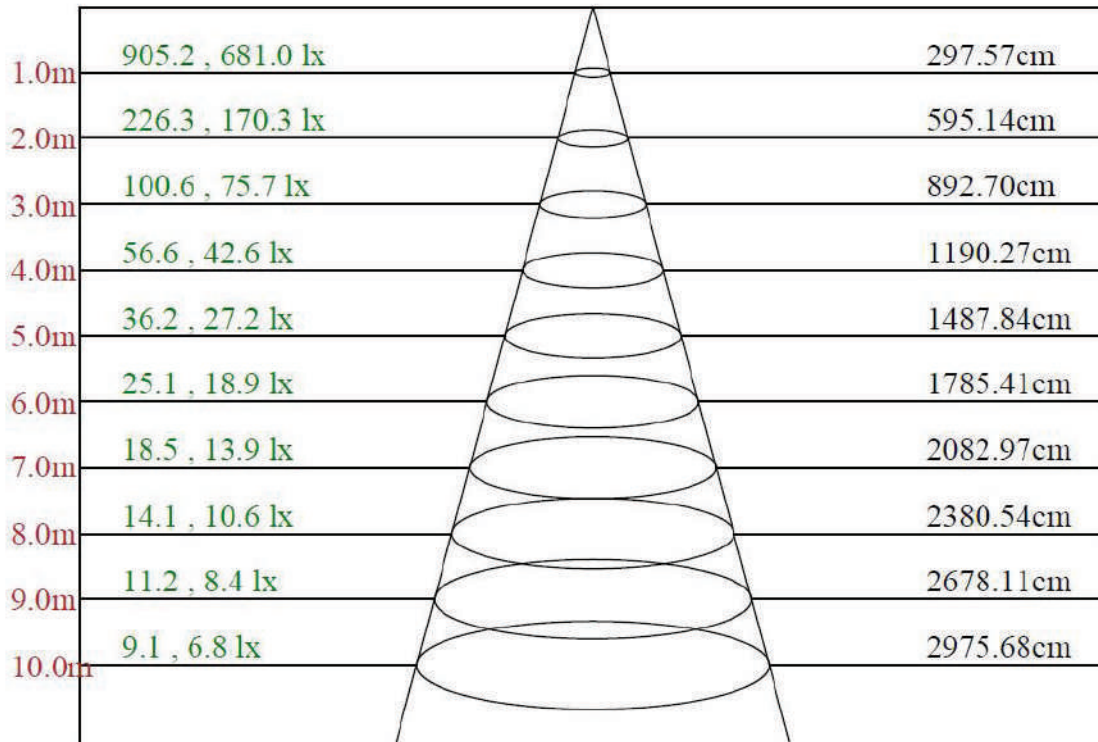

Max , Ave Beam angle of C157.5plane112.14

Test Condition

Temperature: 25°C

RH: 58%

Spectrum Range: 350-800 nm

Scan Step: 5 nm

Spectroradiometric Parameters

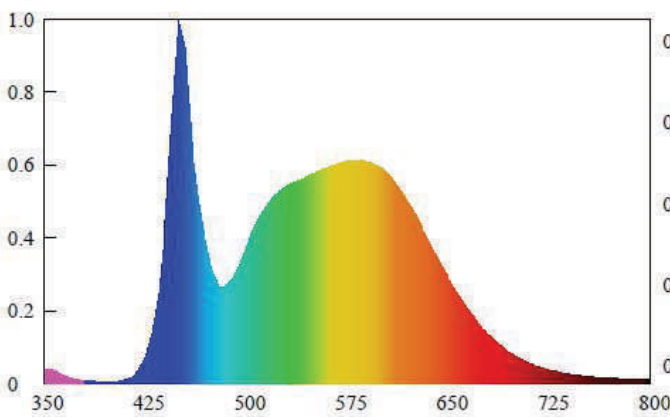

Spectral Distribution

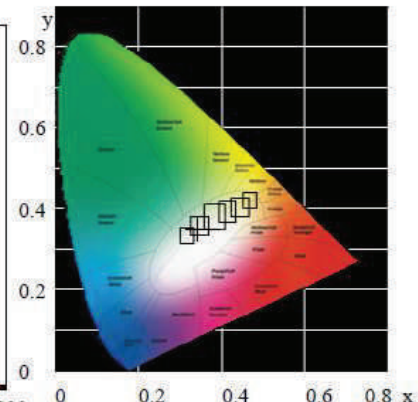

CIE1931 Chromaticity Diagram

Distribution Diagram - 28W

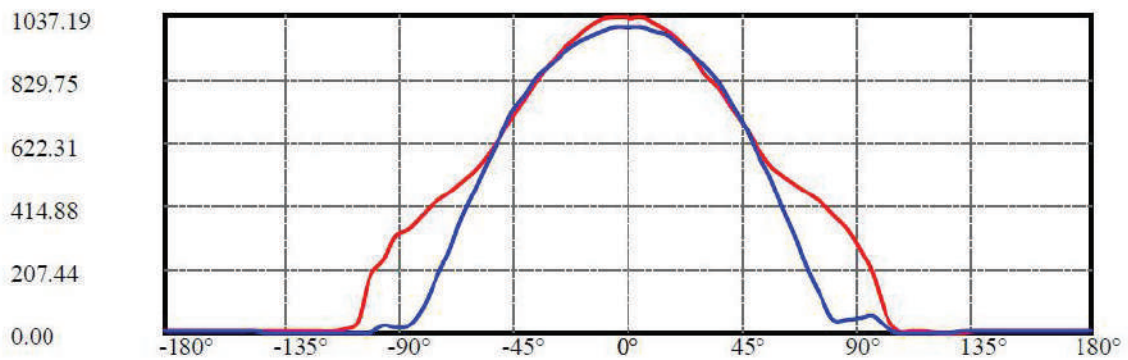
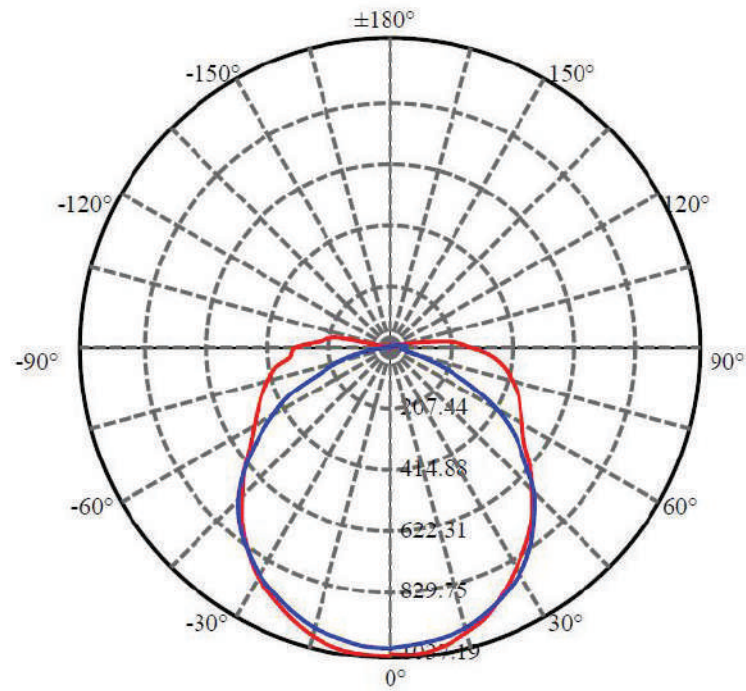

C0/C180: —
 C90/C270: —

Field angle(10%Imax):C0/180Left:102.7 Right:98.4

:C90/270Left:79.0 Right:76.2

Beam Angle(50%Imax):C0/180Left:61.2 Right:59.4

:C90/270Left:57.8 Right:55.3

Distribution Diagram - 28W

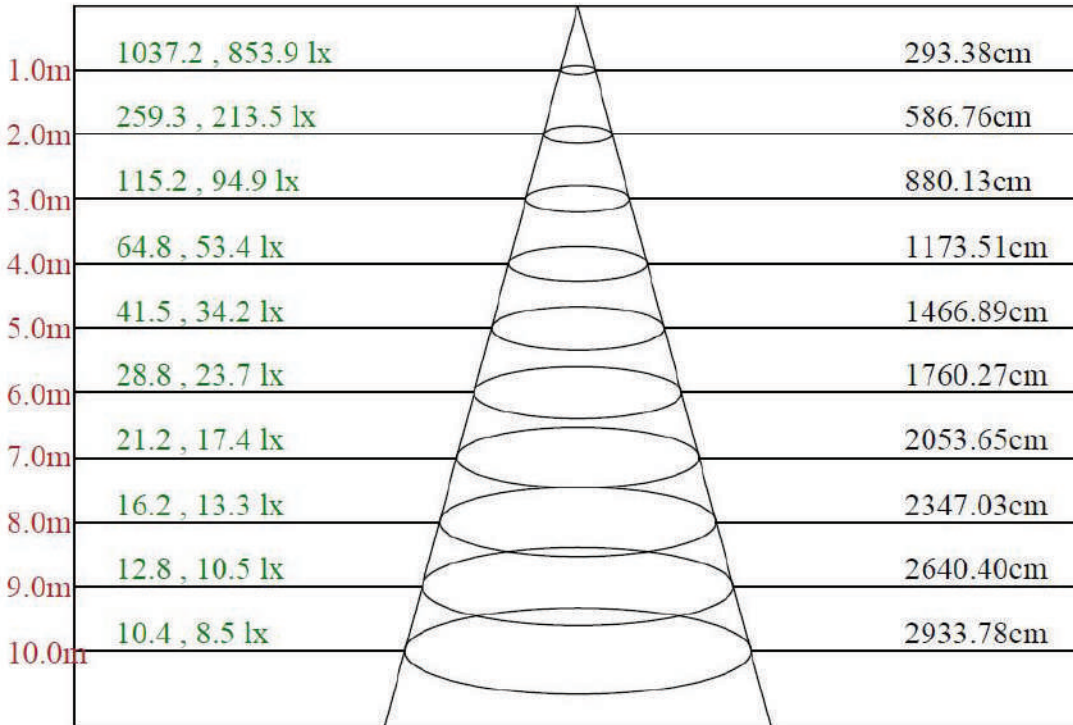

Max , Ave Beam angle of C67.5plane111.17

Test Condition

Temperature: 25°C

RH: 58%

Spectrum Range: 350-800 nm

Scan Step: 5 nm

Spectroradiometric Parameters

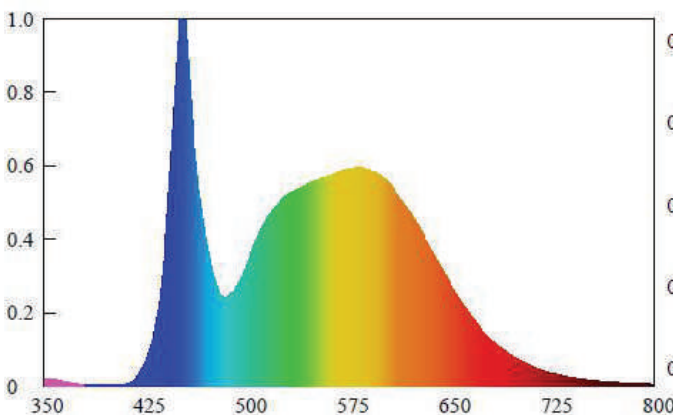

Spectral Distribution

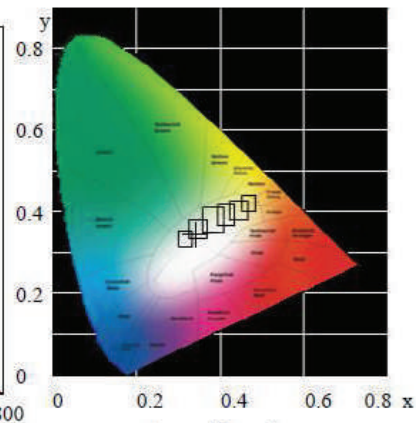

CIE1931 Chromaticity Diagram

LED COOLER LIGHT

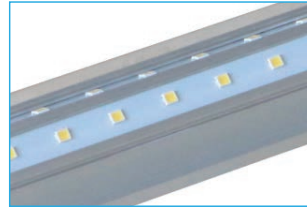

Apply to food plants, dairy plants, pharmaceutical plants, supermarkets, hospitals, various freezers, cold storage and other places for fixed lighting.



LED COOLER LIGHT



LED COOLER LIGHTS



LED COOLER LIGHT



LED COOLER LIGHTS