

## LED Tape Light

Nothing But LEDs Carson Tape Light is an energy-efficient, reliable, compact, and long-lasting product that has a max run of 16 Feet and emits up to 260 lumens per ft by only utilizing about 2.5 watt per ft of power. It is easy to install and operate, as its peel and stick adhesive backing simplifies its mounting and usage. It offers spotless soft light with instant start eliminating shadows and humming. Carson tape light offers an ideal solution for all indoor applications particularly offices, cabinets, displays, and decorative and creative projects for residential and commercial applications.

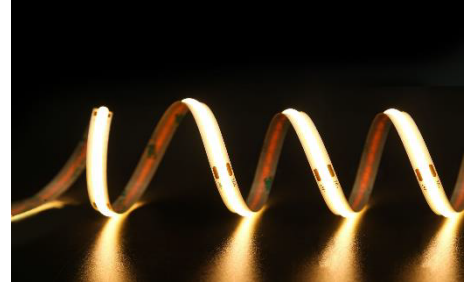

### Product Features

- Operating temperature: -20°C to 60°C
- Peel and stick adhesive backing simplifies mounting
- 98 LEDs per FT
- 16FT total length per strip
- Better heat dissipation
- High package density
- More Flexible
- No holder and alloy wire, less production processes, more reliable
- Integral LED driver, eliminates the need for an external driver or ballast
- Complies with UL safety regulations
- This product is IP22 rated, therefore, it is typically suited for indoor applications
- Spotless soft light without shadow
- Environment friendly with no mercury
- Easy to install and operate, with instant and no humming
- Energy saving with long lifespan

Model #	Watts	Lumens	Length	CCT	CRI	IP	Certifications
BLT-FN-COB-320-24-W9K30-B8W2	40W	3760LM	16 FT	3000K	90	IP22	UL
BLT-FN-COB-320-24-W9K60-B8W2	40W	3760LM	16 FT	6000K	90	IP22	UL

SKU #	Model #	Watts
<b>General Performance</b>	Model #	BLT-FN-COB-320-24-W9K30-B8W2
	Product Description	Led Flexible Strip Light 16' (WATT) 3000K W/60W-24V Power Supply
	Wattage	40W
	Lumen	Up to 3760LM
	Lumen Efficacy	Up to 94LM/W
	Color Temperature	3000K
	CRI (Ra)	>90
	Beam Angle	180 Degree
<b>Electrical</b>	Input Voltage	24V
	Dimming	0-10V dimming standard
<b>Physical</b>	Operating Temperature	-20°C TO 60°C
	Storage Temperature	-20°C TO 70°C
	Cutable Length	1.97 in
	Strip Width	0.31 in
	Total length per strip	16 FT
	Operating Length	2.44W/FT
<b>Qualification</b>	IP Rating	IP22
	LEDs/FT	98
	Warranty	3 Years

SKU #	Model #	Watts
<b>General Performance</b>	Model #	BLT-FN-COB-320-24-W9K60-B8W2
	Product Description	Led Flexible Strip Light 16' (WATT) 6000K W/60W-24V Power Supply
	Wattage	40W
	Lumen	Up to 3760LM
	Lumen Efficacy	100LM/W
	Color Temperature	6000K
	CRI (Ra)	>90
	Beam Angle	180 Degree
<b>Electrical</b>	Input Voltage	24V
	Dimming	0-10V dimming standard
<b>Physical</b>	Operating Temperature	-25°C TO 45°C
	Cutable Length	1.97 in
	Strip Width	0.31 in
	Total length per strip	16 FT
	Operating Length	2.44W/FT
<b>Qualification</b>	IP Rating	IP22
	LEDs/FT	98
	Warranty	3 Years

## Correlated Color Temperature (CCT)

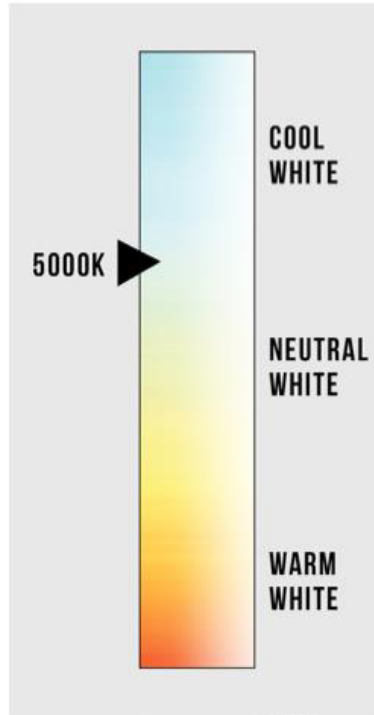

## Dimensions

**\*\* Figure below taken from catalog \*\***

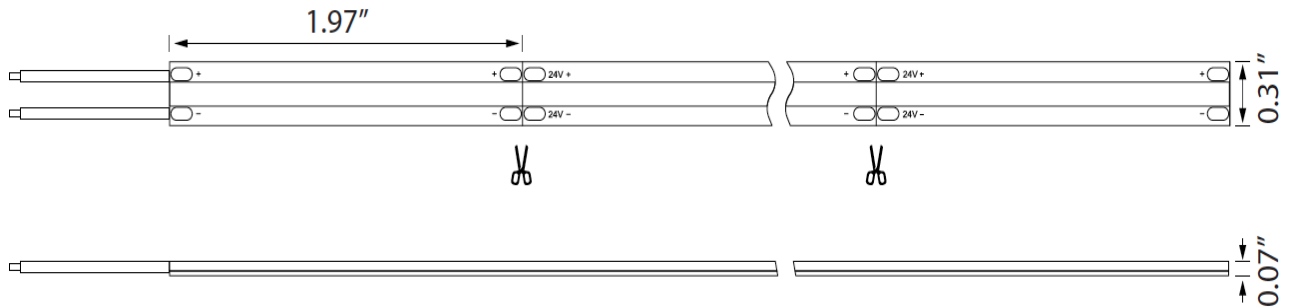

## Photometric Data

### Luminous Intensity Distribution Curve

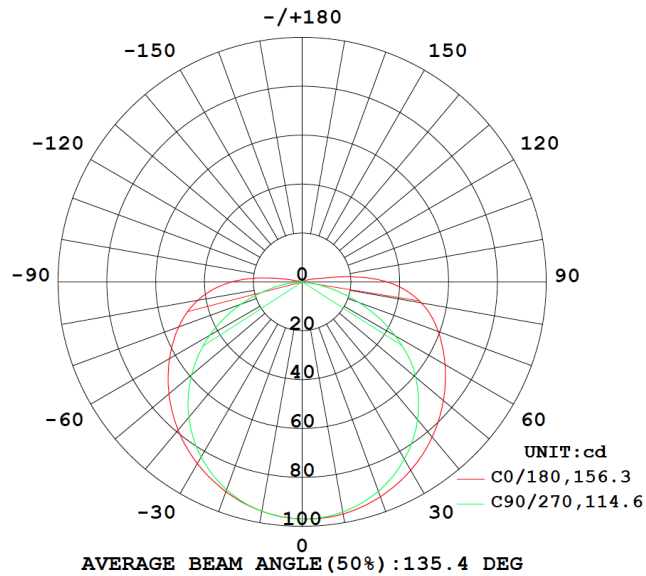

### Illuminance at a Distance

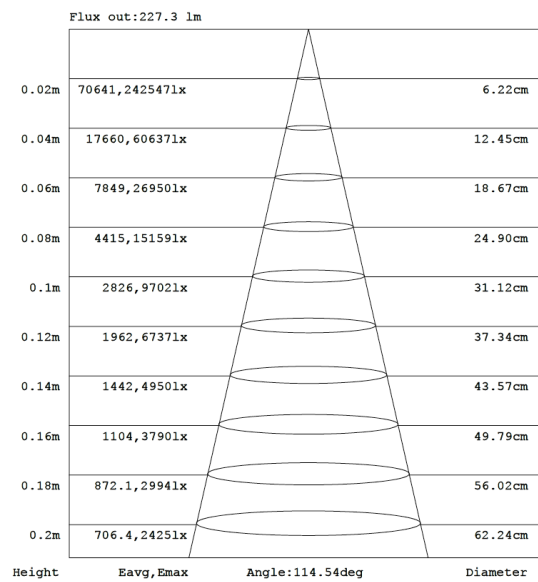

## Packaging

Bracket Type	Size	Qty/Box	G.W./Box
Outer box	13.00 X 11.02 X 7.48 in	10 PCS	22.05 lbs
Blister	10.63 X 7.09 X 1.97 in	1PC	2.20 lbs
Card	10.60 X 7.00 in	1PC	With Blister

Tolerance of Carton Size: ±15 MM, Tolerance of Weight: ±10%.

## Blister

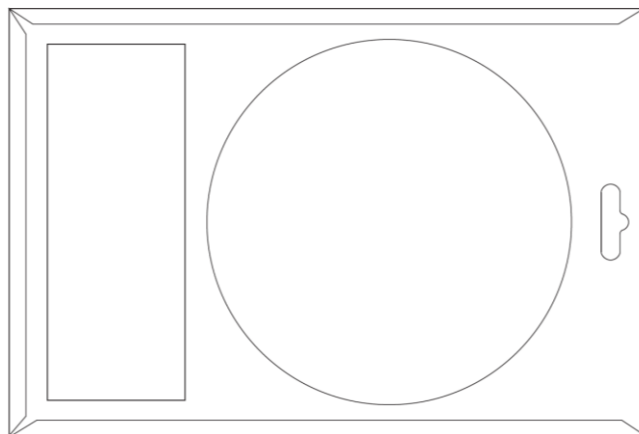

## Card

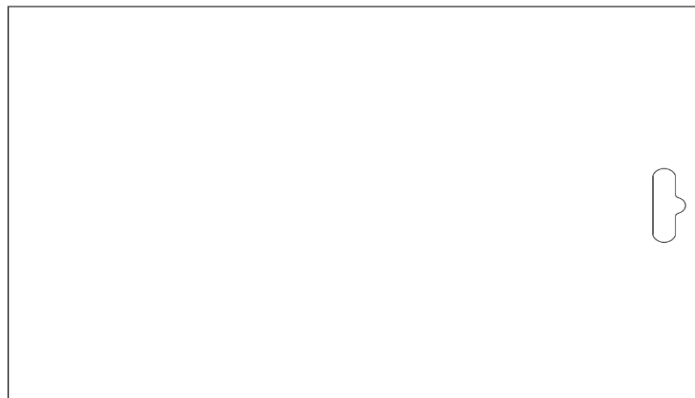

## Application



## Safety Precautions

To reduce the risk of death, personal injury or property damage from fire, electric shock, falling parts, cuts/abrasions, and other hazards read all warnings and instructions included with and on the fixture box and all fixture labels. Before installing, servicing, or performing routine maintenance upon this equipment, follow these general precautions. Commercial installation, service and maintenance of luminaires should be performed by a qualified licensed electrician.

For the installation: If you are unsure about the installation or maintenance of the luminaires, consult a qualified licensed electrician and check your local electrical code. To prevent wiring damage or abrasion, do not expose wiring to edges of sheet metal or other sharp objects. Do not make or alter any open holes in an enclosure of wiring or electrical components during kit installation.

### **WARNING: RISK OF FIRE OR ELECTRICAL SHOCK**

Turn off electrical power at fuse or circuit breaker box before wiring fixture to the power supply. Turn off the power when you perform any maintenance. Verify that supply voltage is correct by comparing it with the luminaire label information. Make all electrical and grounded connections in accordance with the National Electrical Code and any applicable local code requirements. All wiring connections should be capped with UL approved wire connectors.

### **CAUTION: RISK OF INJURY**

Avoid direct eye exposure to the light source while it is on.  
Account for small parts and destroy packing material, as these may be hazardous to children.

## Warranty

3 Year Warranty.