

LED DISK LIGHT



Nothing But LED's disk light can be direct wired to a 6" junction box which means they do not need a can and it also comes with retrofit kit for easy and fast installation. It's surface mounts directly to the ceiling for instant bright light. Perfect for residential or commercial applications with exceptional color rendering of 90 CRI and available in 5 CCT Adj. 2700K / 3K / 3500K / 4K / 5K color temperatures. With a life rating of at least 50,000 hours, they greatly minimize the cost of ownership through reduced maintenance and lower utility costs. Fixtures are ENERGY STAR certified, rated for wet location and support California Title 24 compliance.

Product Features

- Up to 100 Lumens per watt
- Available in 6"
- 5 CCT Adj. 2700K/3000K/3500K/4000K/5000K
- (DOB) Driver-on-board technology
- Triac Dimmable down to 5% of total light output
- Suitable for Damp Locations
- Easy Surface Mount or Retrofit installation
- ETL & Energy Star listed
- 5 Year warranty

LED DISK LIGHT



SKU #	Model #	Watt	Lumens	CCT Adjustable	Size	Housing	Input Voltage	Dimming	Certifications
1560781	DL205T-6-15W-5CCT-R90-0001	15W	1500Lm	2700K/3K/ 3500K/4K/5K	6"	White	120V	Triac Dimmable	ETL & ES

SKU Number 1560781 Specifications

Parameter	Description	Value
General Performance	Model #	DL205T-6-15W-5CCT-R90-0001
	Wattage	15W
	Lumen	1500LM
	Lumen Efficacy	Up to 110LM/W
	Color Temperature	2700K / 3000K / 3500K / 4000K / 5000K
	CRI (Ra)	>90
	Beam Angle	110° Degree
	Diffuser Type	PC
Electrical	Input Voltage	120Vac
	Frequency	50/60Hz
	Dimming	Triac Dimmable
	Power Factor	≥0.9
	Driver Surge Protection	2.5KV
	Operating Temperature	-20 ± 40
Physical	Operating Humidity	20% - 90%
	Storage Temperature	-30°C - 80°C
	Storage Humidity	10% - 95%
	LED Brand	N/A
	LED Type	2835
	LED QTY	66PCS
	Housing	White
Housing Color	White	
Qualification	IP Rating	IP43
	Warranty	5 Year Warranty

LED DISK LIGHT

Correlated Color Temperature (CCT)

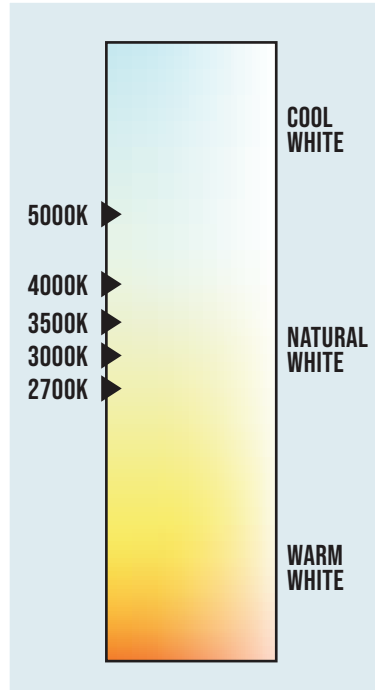

Dimensions

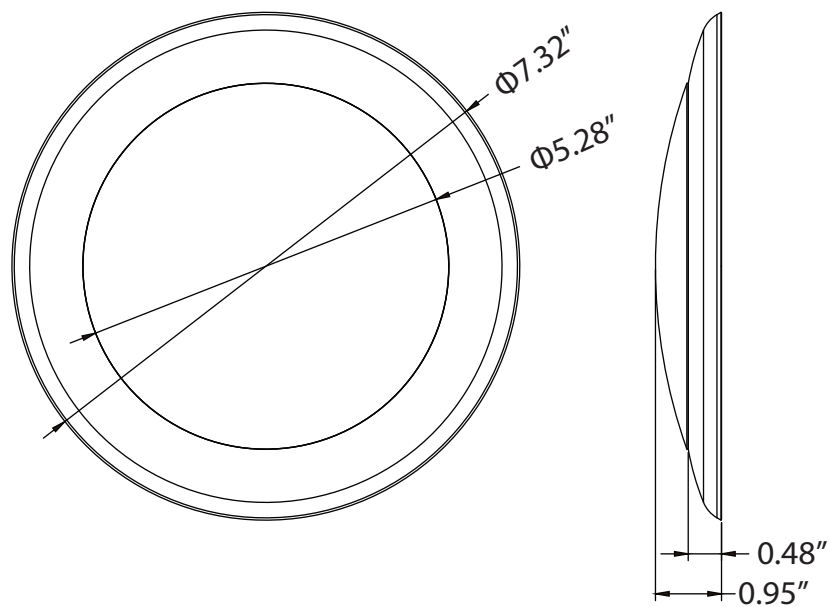

LED DISK LIGHT



SKU: 156784:

Installation Accessories



LED DISK LIGHT

Accessories

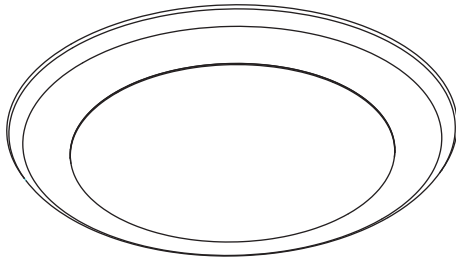

6in Round LED Disc



Mounting Screws

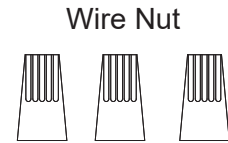

Wire Nut

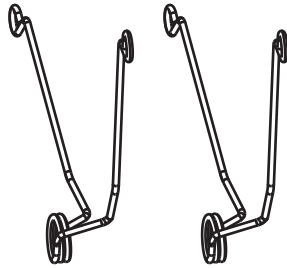

Spring Iron Support

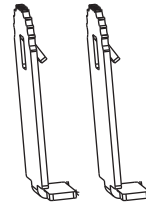

Mounting Iron

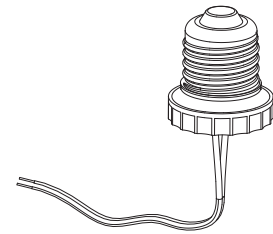

E26 Base Whip

Installation

Safety Information

WARNING: These products may represent a possible shock or fire hazard if improperly installed or attached in any way. Products should be installed in accordance with these instructions, current electrical codes, and/or the current National Electric Code (NEC). Disconnect power to the unit prior to installation.

WARNING: To reduce risk of fire, electric shock, or injury to persons

Read all installation instructions before beginning. If you have any doubts about how to install this lighting fixture, or if the fixture fails to operate completely, consult a qualified electrician to ensure correct branch circuit conductor.

This fixture is designed for use in a circuit protected by a fuse or circuit breaker.

Always be sure that power supply is turned off at fuse box or circuit breaker before installing, cleaning, or servicing the fixture.

LED DISK LIGHT



Installation

This product must be installed in accordance with the applicable installation code by a person familiar with the construction and operation of the product and the hazards involved.

Supply conductors (Power Wires) Connecting the fixture must be rated minimum 90°C. If uncertain, consult an electrician.

To reduce the risk of fire, electric shock or injury to persons, do not make or alter any open holes in a wiring enclosure nor in any electrical components during kit installation.

To prevent wiring damage or abrasion, do not expose wiring to edges of sheet metal or other sharp objects.

There are no serviceable parts inside the fixture.

Suitable for use in wet locations.

This fixture is rated TYPE NON-IC and is not suitable for direct contact with insulation.

The installer must determine that supply power is 120V AC 60Hz at the luminaire before installation.

The National Electric Code (NEC) does not permit cords to be concealed where damage to the cord's insulation may go unnoticed. To prevent fire damage, do not run cord behind walls, ceilings, soffits, or cabinets where it may be inaccessible for examination. Cords should be visually examined periodically and immediately replace when any damage is noted.

Do not cover the fixture with any heat insulated materials.

To avoid electrical shock, do not operate fixture with missing or damaged lens.

WARNING: To reduce risk of cuts

Some metal parts in the fixture may have sharp edges. Wear gloves when handling the part.

SAVE THESE INSTRUCTIONS

For safest operation, read and become familiar with complete installation instructions prior to use. Pay close attention to this manual and stay within its guidelines when using this product.

CAUTION:

All parts must be used as indicated in this manual. Do not substitute any parts, leave parts out, or use parts that are worn out or broken. Failure to obey this instruction could invalidate the ETL certification.

LEDs emit bright light. Avoid looking directly at the light source.

Accounts for small parts and destroy packing material, as these may be hazardous to children.

Preparation

Before beginning assembly, installation, or operation of product, make sure all parts are present.

Compare parts with package and hardware contents list on page 1. If any part is missing or damaged, do not attempt to assemble, install or operate the product. Contact customer service for replacement parts.

Tools Required for Assembly (not included): Ladder, safety glasses

Estimated assembly time: 15-20 minutes per fixture

Installation Instructions

WARNING

Turn off electricity at main fuse box (or circuit breaker box) before beginning installation by removing fuse (or switching off circuit breaker).

Be careful not to damage or cut the wire insulation (covering) during fixture installation. Do not permit power cord or housing to contact any surface having a sharp edge. To do so may damage or cut the wire insulation, which could cause serious injury or death from electric shock.

This fixture is rated for 120V AC operation and draws 15W per fixture. The installer must determine whether supply power is appropriate prior to installation.

For installation direct to the ceiling via 6" octagonal junction box, see Steps 1-4. For installation to 5"/6" recessed housing, see Steps 5-7.

Installation

CCT selectable
by dip switch

5 CCT selectable

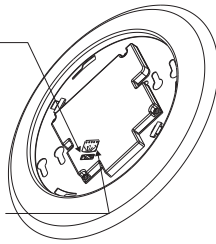

Note

Toggle the dip switch on the back of the disc light (A) to select the correlated color temperature (CCT) prior to installation.

For surface mounting

1. Turn off the circuit breaker and light switch.;
Twist to detach the lamp shade from the mounting plate and set aside.;
Install the two screws into the junction box and leave 1/4" of screw exposed to accommodate mounting plate (See Figure 1).

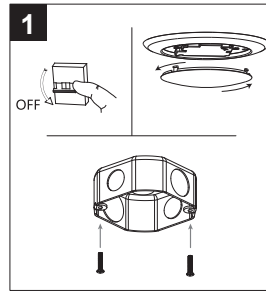

2. Connect the house ground wire, black wire and white wire to mounting plate ground wire, black wire and white wire using the nut.;
Attach the mounting plate to the junction box by aligning the holes on mounting plate with the screws on the junction box.;
Turn mounting plate counterclockwise to lock in place and tighten (See Figure 2).

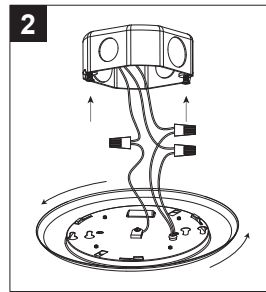

3. Reattach lamp shade to mounting plate and twist to lock in place (See Figure 3).;

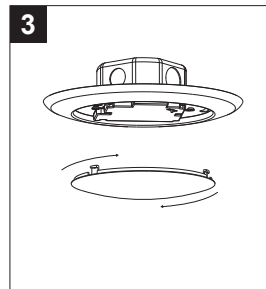

4. Turn on the circuit breaker and light switch, testing the light fixture.

For 5"/6" recessed housing

5. Spring iron bracket (D) and mounting patch (E) inlay stable, mounting patch (E) and 6inch Round LED Disc inlay stable

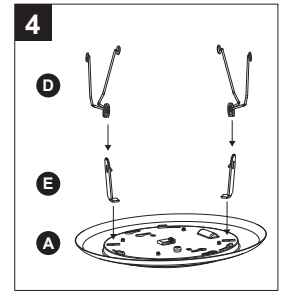

6. Connect the E26 base whip (F) to the fixture (A) by making wire connections using wire nuts (C): black to black and white to white. Tuck the ground wire away. Then connect the E26 base whip (F) to the socket inside of the recessed.

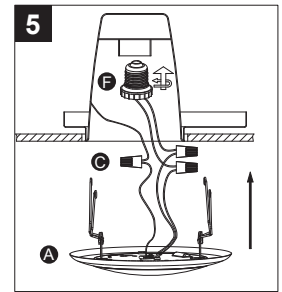

7. Push the disc light (A) up in to the recessed housing, being sure not to pinch or nick any of the wires.

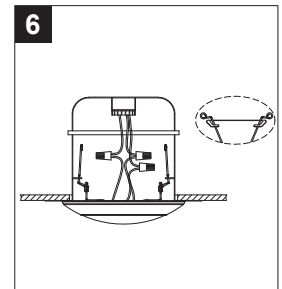

LED DISK LIGHT



Dimming Information

This product is suitable for use in dimming circuits. For 10-100% light control, use with an LED-compatible dimmer (sold separately).

Care And Maintenance

Use only a mild soap and/or water with a soft cloth to clean the fixture. Harsh chemicals will damage the fixture. Do not wipe the fixture with a rough cloth that may scratch the finish or the lens.

Trouble Shooting

The light does not come on at all:

- a) With power supply turned off, ensure all connections are made correctly.
 - b) Make sure the circuit breaker is on and that switch controlling branch circuit is on.
- If one of these fix this issue, please consult a certified electrician.

Five-Year Limited Warranty

If, during normal use, this lighting fixture breaks or fails due to a defect in material and workmanship within five (5) years from the date of original purchase, simply bring this lighting fixture with your original sales receipt back to your nearest retail store. At its discretion, to have the product or any defective part(s) repaired or replaced with the same or similar product free of charge, within the stated warranty period, when returned by the original purchaser with original sales receipt. This warranty; (1) excludes expendable parts including but not limited to light bulbs; (2) does not cover damage that has resulted from abuse or misuse; and (3) does not cover any losses, labor, injuries to persons/property or costs.

Packaging

Size	Carton Size (Inches)	Pcs/Carton	Net Weight	Gross Weight
6"	15.74 x 8.07 x 8.27	12 Pcs/Box		

Warranty

5 Years Warranty

LED DISK LIGHT

Application



LED DISK LIGHT