

Our new LED Down Light is economical and is equipped with a smooth trim that fits most manufacturer's 6" recessed can style housings. It utilizes adjustable torsion springs, can be Triac Dimming and maintains 70% light output after 35,000 hours of use. This makes it perfect for applications such as multi-family residences, retail shops and offices.

## Product Features

Up to 70 Lumens per watt  
5 CCT Adjustable 2700K / 3K / 3500K / 4K / 5K  
Triac Dimming  
Input Voltage 120V / 60Hz  
Available in 6 Inches

No flickering-free driver  
Adopt spinning Aluminum as heat sink  
High efficiency and energy-saving LED driver  
ETL & ES Listed  
5 Year Warranty

# LED DOWN LIGHTS



SKU #	Model #	Watt	Lumens	CCT Adjustable	Size	Input Voltage	Dimming	Certifications
1560731	DL207BT-6-15W-5CCT-R90-0001 (Baffle)	15W	1050lm	2700K/3K/3500K/4K/5K	6"	120Vac	Triac Dimmable	ETL & ES

## Specifications

Parameter	Description	Value
General Performance	Model #	DL207BT-6-15W-5CCT-R90-0001 (Baffle)
	Wattage	15W
	Lumen	1050LM
	Lumen Efficacy	Up to 70LM/W
	Color Temperature	2700K / 3000K / 3500K / 4000K / 5000K
	CRI (Ra)	>90
	Beam Angle	100° Degree
	Diffuser Type	PC Lens
Electrical	Input Voltage	120Vac
	Frequency	60Hz
	Dimming	Triac Dimmable
	Power Factor	≥0.9
	Driver Surge Protection	Yes, Surge protection voltage 500V
	Flicker Percent	6.5%
Physical	Operating Temperature	-20°C to 40°C
	Operating Humidity	RH90%
	Storage Temperature	-40°C to 60°C
	Storage Humidity	RH90%
	LED Brand	HongLi
	LED Type	SMD2835
	LED QTY	28 Pcs
	Housing	Aluminum
	Housing Color	White with Baffle
Qualification	IP Rating	Wet Location
	Warranty	5 Years Warranty

## Product Appearance

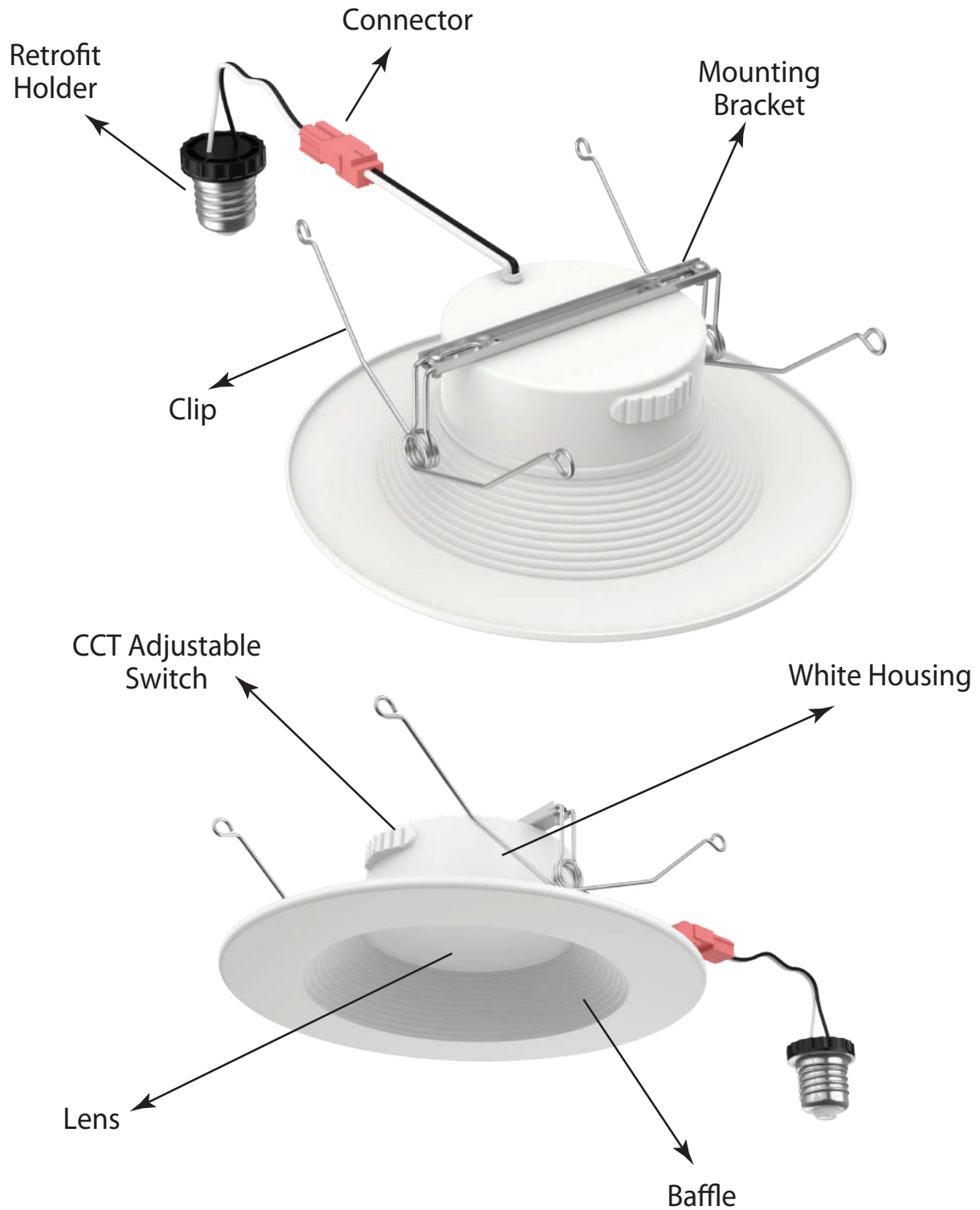

## Correlated Color Temperature (CCT)

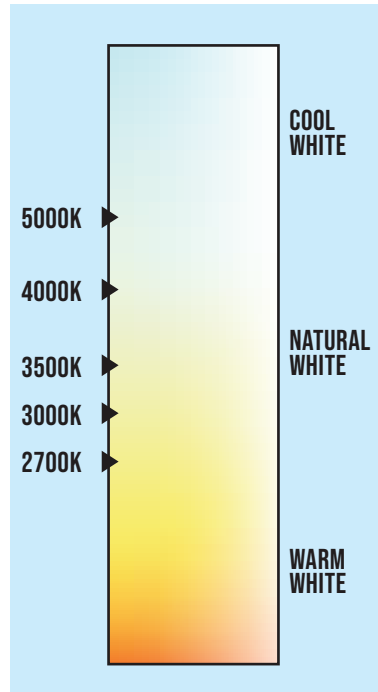

## Product Dimension

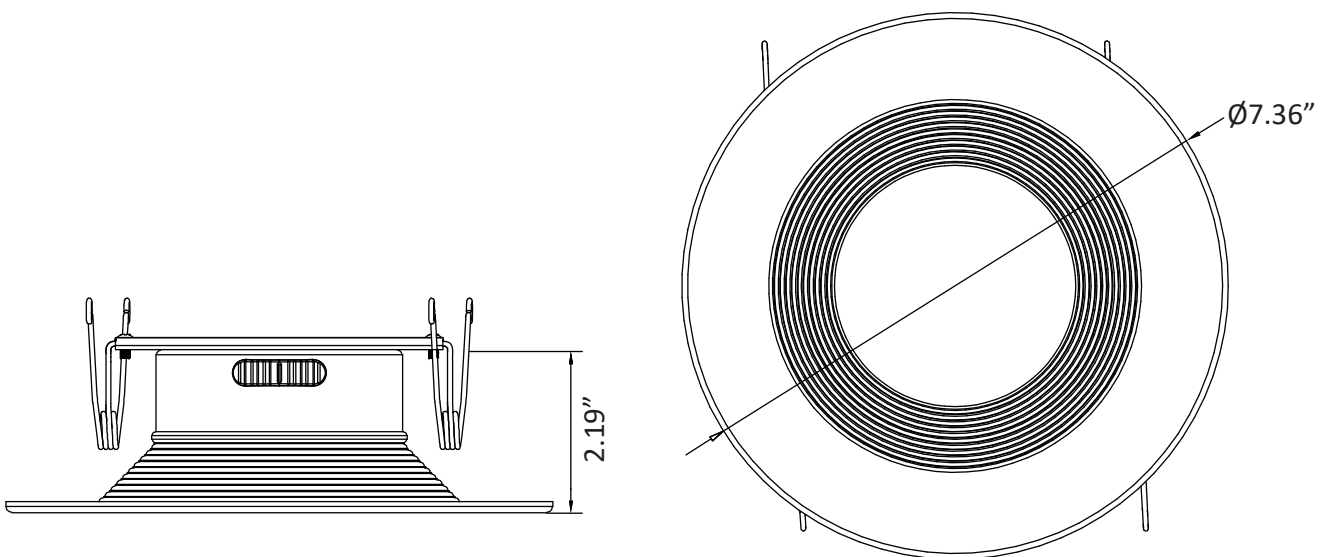

6 Inch Baffle

## Test Report

Flux out:585.5 lm

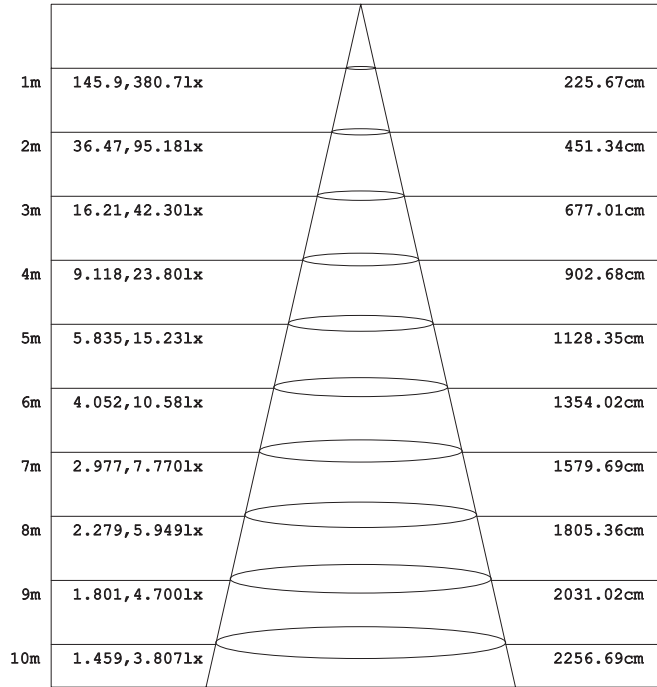

Angle:96.90deg  
 Note: The Curves indicate the illuminated area and the average illumination when the luminaire is at different distance.

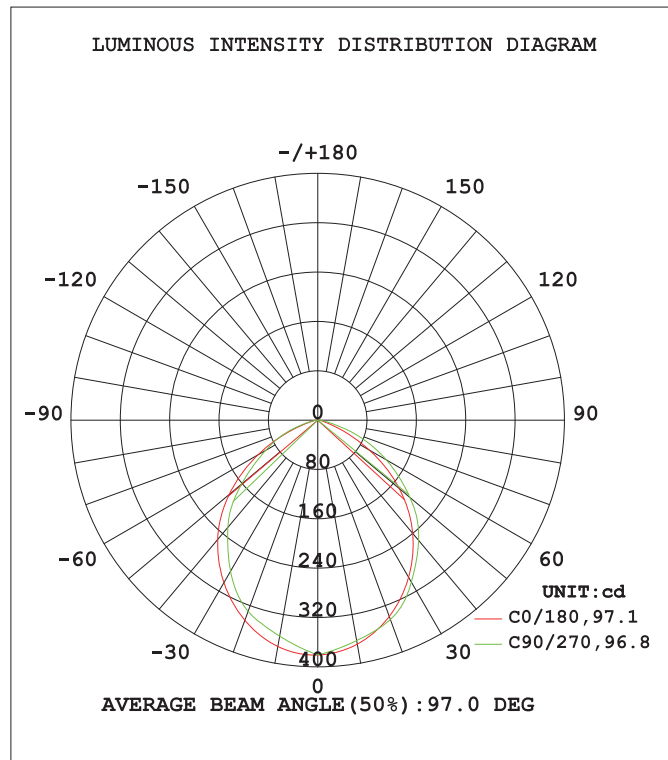

## Installation

### SAFETY INFORMATION:

Read all instructions before beginning. Save these instructions for future use.

To reduce the risk of fire, electric shock, or injury to persons, pay close attention to this manual and stay within its guidelines when using this product.

Installation of this fixture requires knowledge of recessed lighting luminaires and their electric systems. If not qualified or uncertain, do not attempt installation. Contact a qualified electrician.

Supply conductors (power wiring) connecting the fixture must be rated for a minimum of 90°C(194°F).

Do not make or alter any open holes in wiring enclosures, nor in any electrical components during installation.

Do not alter, relocate, or remove wiring, lamp holders, power supply, or any other electrical component.

To prevent wiring damage or abrasion, do not expose wiring to edges of sheet metal or other sharp objects.

To avoid electrical shock, do not turn on fixture with missing or damaged lens.

This downlight is suitable for use in wet locations and is rated Type IC.

There are no serviceable parts inside of the LED module.

### CAUTION:

These retrofit luminaires are designed to install in standard 4" and 5"-6" recessed downlight housing only. Do not attempt to alter for other size or purpose. Before beginning installation, confirm housing compatibility by checking the interior of the housing for a manufacturer's part number and specifications; or measure the diameter of the housing. The recessed housing must have a minimum measured inside diameter of 5-1/4" and a maximum measured inside diameter of 6-3/4". Turn power off before starting installation.

## 5-6 Inch LED Retrofit Downlight

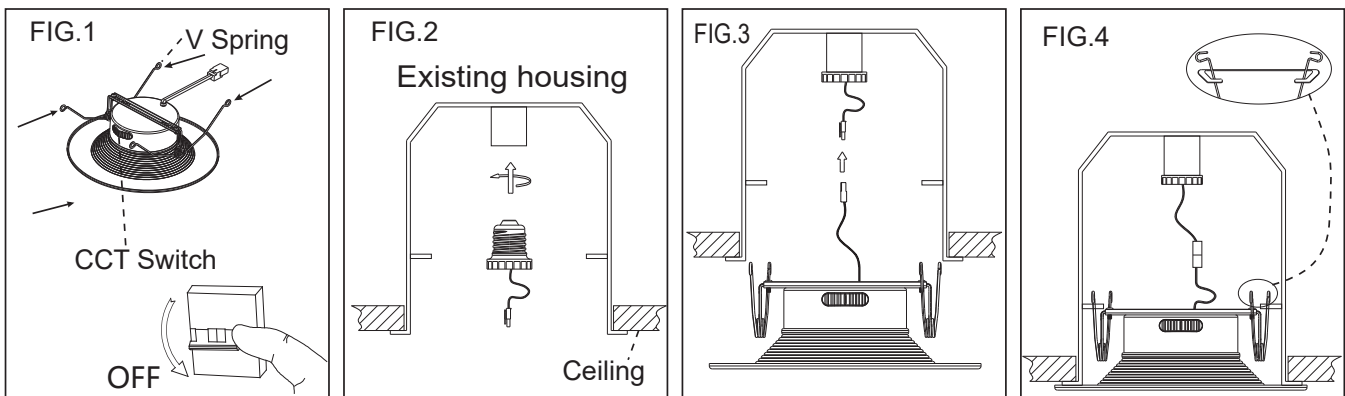

## Installation

### Installation For 5-6 Inch (See FIG.1-4):

Turn off the power supply, and take the CCT switch to your position.

If install into 6" can housings, no adjusting the V spring are need. Go to step 3.

If install into 5" can housing: Adjusting the V spring is suited to the housing. Then, Go to step3. (FIG.1)

Thread the socket adapter into the socket. (FIG.2).

Plug the female connector of the retrofit trim onto the male connector of the socket adapter assembly. (FIG.3)

Squeeze both V spring arms together and insert into the V spring slots of the can. Tuck all wires into the can and carefully push the retrofit downlight into can housing (FIG.4)

### Installation For 4" (See FIG.5-8):

1. Turn off the power supply and take the CCT switch to your position (FIG.5).

Thread the socket adapter into the socket. (FIG.6)

Plug the female connector of the retrofit trim onto the male connector of the socket adapter assembly. (FIG.7)

Squeeze both the spring arms together and insert into the spring slots of the can. Tuck all wires into the can and carefully push the retrofit downlight into can housing (FIG.8)

### Dimming Information:

This product is suitable for use in dimming circuit. For 5-100% light control, use with a compatible dimmer.

Compatible dimmers include most standard dimmers, such as Lutron:

SCL-153P, DVCL-153P, MACL-153MR-WH,

TG-600PH-LA, MACL-153ME, DV-600P

Leviton: CL-6674, CL-6672, CL-6683, IPL06, 153M-ES

## 4 Inch LED Retrofit Downlight:

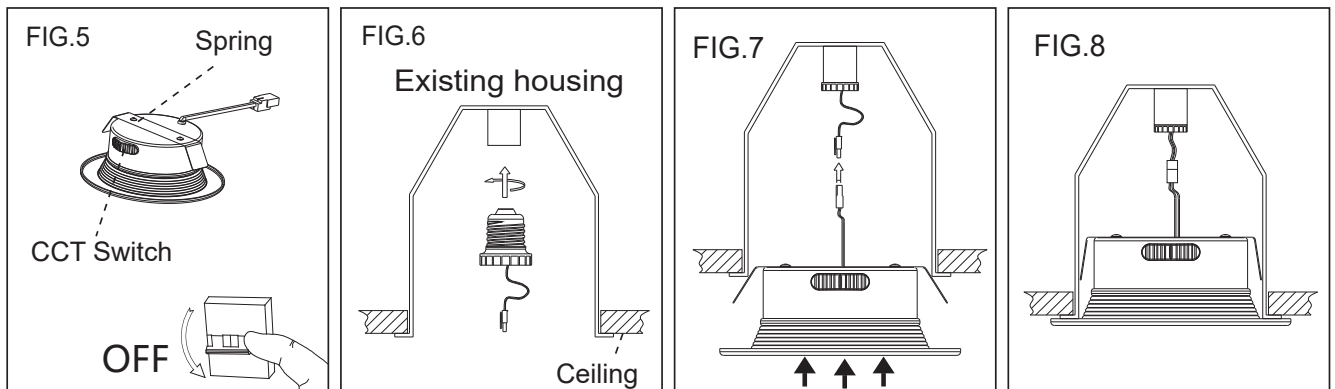

# LED DOWN LIGHTS



## Box Dimensions

SKU	Box Type	Dimenstions	Qty	Net Weight	Gross Weight
1560731	Outer Box	21.26 x 18.11 x 8.85	12 Pcs/Box	5.02 LBS	7.52 LBS

## Application Images





## Application Images



## Warranty

5 Years Warranty