



Nothing But LEDs Flood light is the newest design for 2023 and comes with adjustable CCT and built-in photocell which makes this product very unique. Our Flood light is ideal to replace Halogen lamps and comes with U-Bracket, optional Knuckle and Yoke mount. This flood light is an extremely cost-effective solution, great for illuminating yards, driveways, signage and security applications.

## Product Features

- Up to 136 Lumens per watt
- CCT adjustable 3000K / 4000K / 5000K
- Beam Angle 150° Degree
- Standard U Bracket Mount
- Input Voltage 120-277Vac
- Heat resistant polycarbonate optical lens
- IP65 Rated
- UL & DLC listed
- 5 Year warranty

# LED FLOOD LIGHT



SKU #	Model #	Watt	Lumens	CCT	Housing	Input Voltage	Type	Certifications
1560254	BLT-FL06E-80WBH8DA1-BRFM30/40/50	80W	10880lm	3K/4K/5K	Bronze	120-277V	U-Bracket	UL & DLC

## SKU #. 1560254

## Specifications

Parameter	Description	Value
General Performance	Model #.	BLT-FL06E-80WBH8DA1-BRFM30/40/50
	Wattage	80W
	Lumen	Up to 10880LM
	Lumen Efficacy	Up to 136LM/W
	Color Temperature	3000K / 4000K / 5000K
	CRI (Ra)	>80
	Viewing Angle	7H6V
	Input Voltage	120-277Vac
	Frequency	50/60Hz
Electrical	Optional Accessory	Surge protector
	PF (Tolerance: -3%)	≥0.9
	THD (Tolerance : +5%)	≤20%
	Driver Model	Beyond Driver
	Operating Temperature	-30°C to 45°C
	Storage Temperature	-40°C to 80°C
Physical	Operating Humidity	20% - 90% RH
	Storage Humidity	20% - 95% RH
	LED Brand	Lumileds
	LED Type	SMD2835
Qualification	LED QTY	128 PCS*2
	Housing	Die-cast aluminum
	Housing Color	Bronze
	IP Rating	IP65
	Warranty	5 Year

# LED FLOOD LIGHT

## Correlated Color Temperature (CCT)

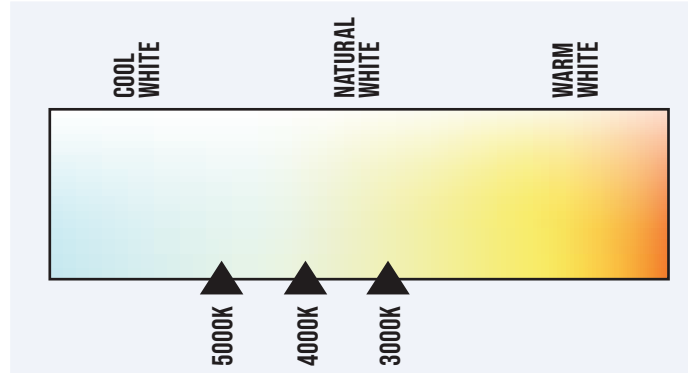

Adjustable CCT Button: 3000K/4000K/5000K

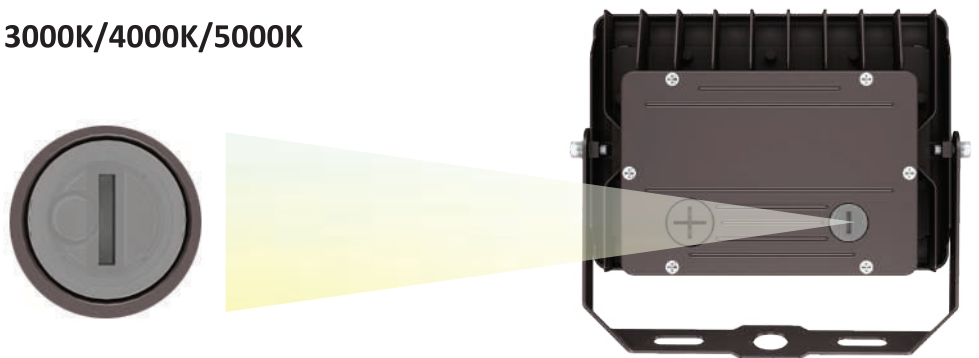

## Dimensions

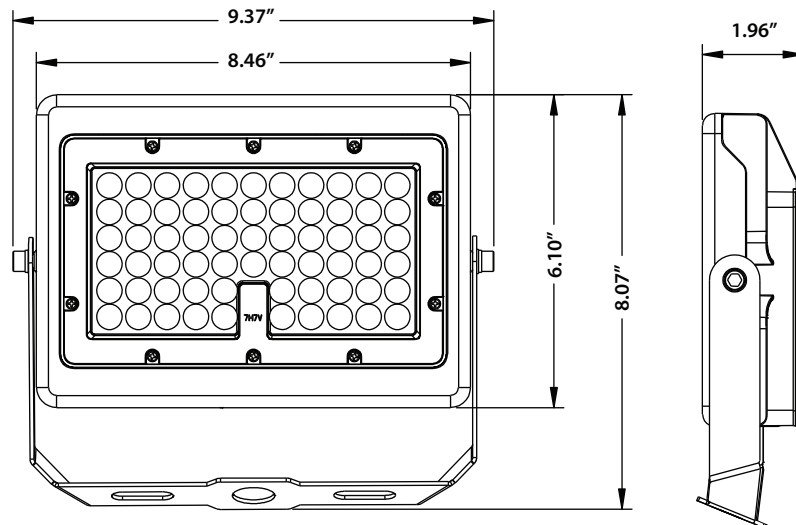

# LED FLOOD LIGHT



## Photometric Data

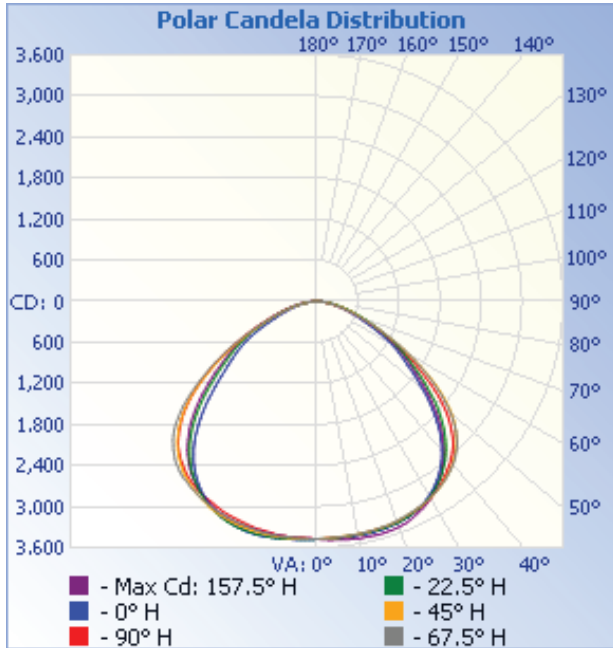

**Illuminance at a Distance**

	Center Beam fc	Beam Width	
17.0ft	12.01 fc	45.3 ft	51.7 ft
34.0ft	3.00 fc	90.7 ft	103.5 ft
51.0ft	1.33 fc	136.0 ft	155.2 ft
68.0ft	0.75 fc	181.3 ft	206.9 ft
85.0ft	0.48 fc	226.7 ft	258.6 ft
102.0ft	0.33 fc	272.0 ft	310.4 ft

■ Vert. Spread: 106.3°  
■ Horiz. Spread: 113.4°

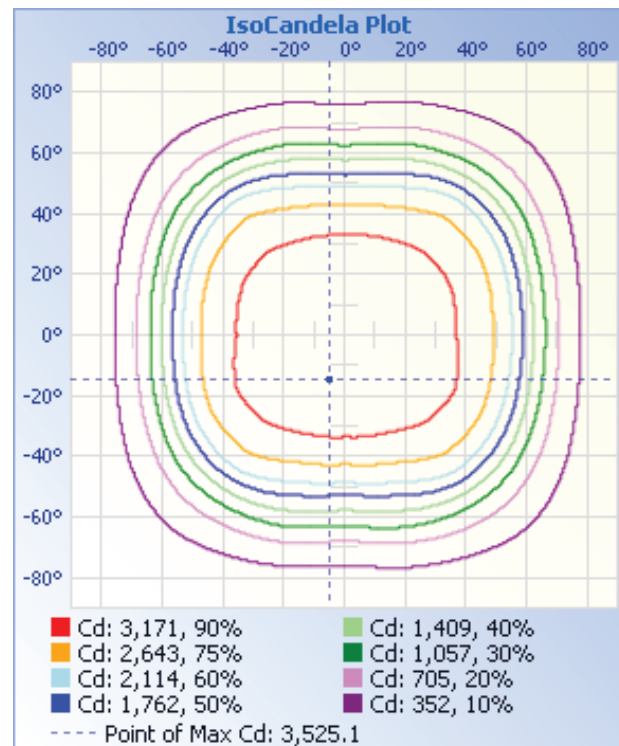
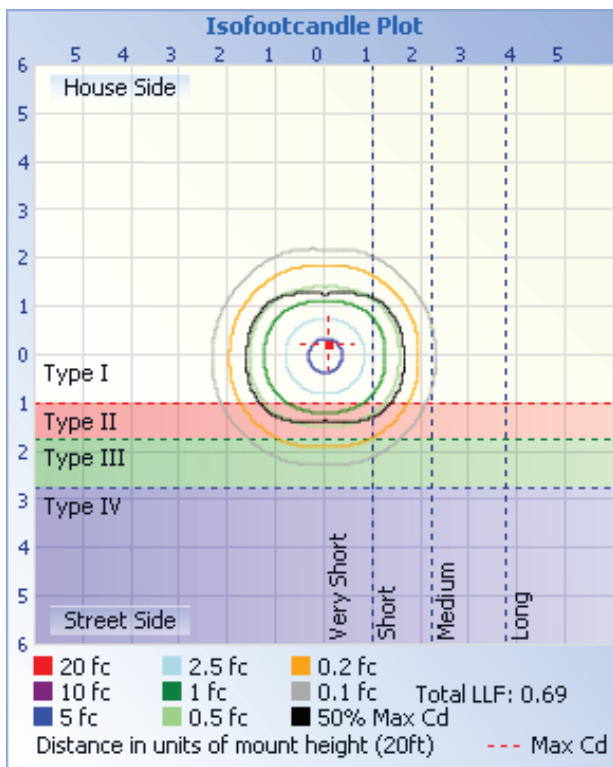

## Installation

### Cautions:

1. Do not use the electric generator to test the LED lamp.
2. Please abide by related country, regional and local law and regulations when install this fixture.
3. Please turn off the power before installation or maintenance.
4. Proper grounding is required to ensure safety.

### Notice:

1. To avoid possibility of electrical shock or fire, the installation personnel must have professional electric knowledge.
2. Please wear gloves to avoid injury before installation.
3. If any smoke or spark of the wire happened, please turn off the power immediately and notify relevant personnel.

### Attention:

1. Please check if there is any damage during shipping. If so, please contact manufacturer timely.
2. Please read the installation instruction carefully to check whether all the accessories are available. After confirmation, install the fixture according to installation steps.

### Instruction:

The installation of this led light with different wattage is different. Please refer to the installation instruction correspondingly.

### Wiring Diagram:

Here is a step color adjusting and power adjusting controller

This is the photoreceptor

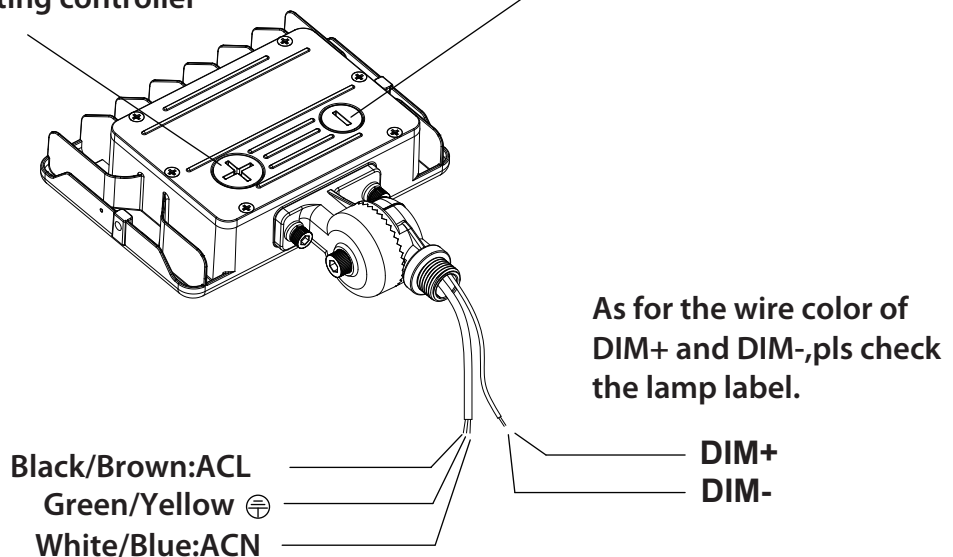

## Installation

### 1.1 Adjustable fitter mounting (b=AM suitable for all power of this series)

Step 1: Take the lamp out of package.

Step 2: pass the wires through hardware and fix it with screws. (figure 1.1)

Step 3: Pass the wires through from the other bracket and rubber, fix it with screws.

(Watch out not to scratch the wire). (figure 1.2)

Step 4: finished. (figure 1.3)

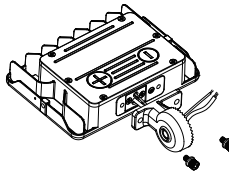

figure 1.1

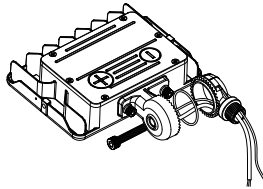

figure 1.2

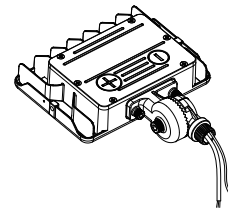

figure 1.3

### 1.3 Installation of led lamp with adjustable fitter (b=AM suitable for all power of this series)

Step 1: Take the lamp out of package.

Step 2: Connect the wires properly according to the right wiring requirements (pay attention to positive wire, negative wire and ground wire) and then put the wires into lamp pole. (figure 1.4)

Step 3: Loosen the screws, adjust the lamp angles as per actual demands and then tighten the screws.

Tips: Angles of the lamp is adjustable (pass the bracket through mounting surface, fix it with screws, then connect the wires as

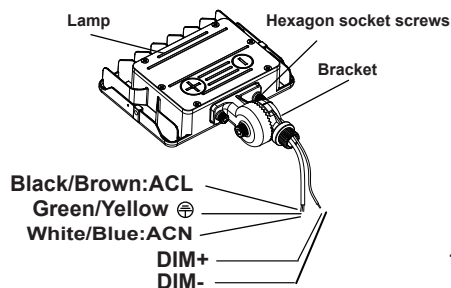

figure 1.4

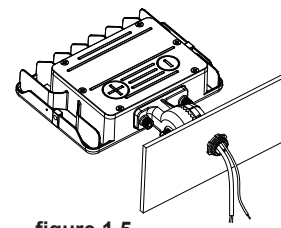
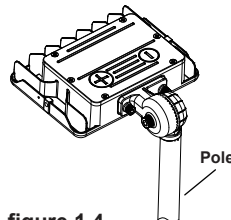

figure 1.5

## Installation

### Installation 2: Installation with Yoke Mount

#### 2.1 Yoke Mount installation (b=YM suitable for all power of this series)

Step 1: Take the lamp out of package.

Step 2: Pass the wires through hole of bracket. (figure 2.1)

Step 3: Fix the lamp and bracket together with screws; (Watch out not to scratch the wire)(figure 2.2)

Step 4: Tighten the other bracket with screws (figure 2.3)

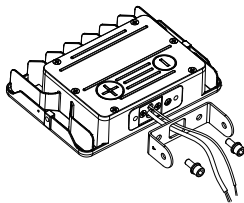

figure 2.1

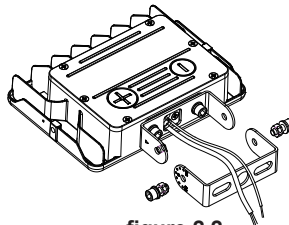

figure 2.2

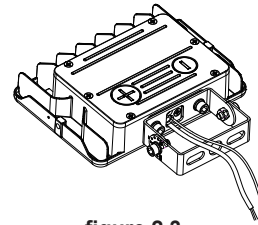

figure 2.3

#### 2.2 Installation of LED lamp with Yoke Mount (b=YM suitable for all power of this series)

Step 1: Take the lamp out of package.

Step 2: Connect the wires properly according to the right wiring requirements (pay attention to positive wire, negative wire, and ground wire) and then put the wires into lamp pole. (figure 2.4)

Step 3: Loosen the screws, adjust the lamp angles as per actual demands and then tighten the screws. (figure 2.5)

Tips: Angles of the lamp is adjustable Led Lamp

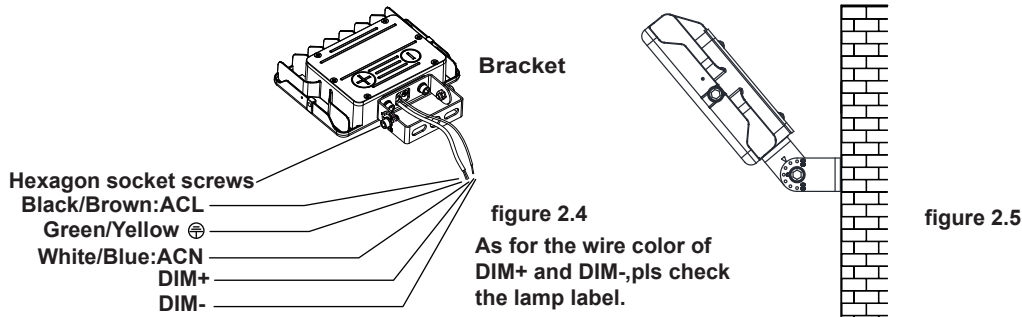

### Installation 3: Installation with Flood Mount

#### 3.1 Flood Mount Installation (b=FM suitable for all power of this series)

Step 1: Take the lamp out of package. (figure 3.1)

Step 2: Tighten the brackets and screws. (figure 3.2)

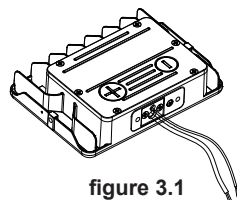

figure 3.1

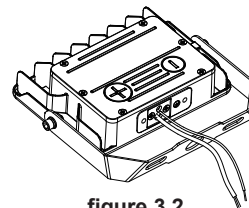

figure 3.2

## Installation

### 3.2 Installation of LED lamp with flood mount (b=FM suitable for all power of this series)

Step 1: Take the lamp out of package.

Step 2: Connect the wires properly according to the right wiring requirements (pay attention to positive wire, negative wire, and ground wire) and then put the wires into lamp pole. (figure 3.3)

Step 3: Loosen the screws, adjust the lamp angles as per actual demands and then tighten the screws. (figure 3.4)

Tips: Angles of the lamp is adjustable Led Lamp

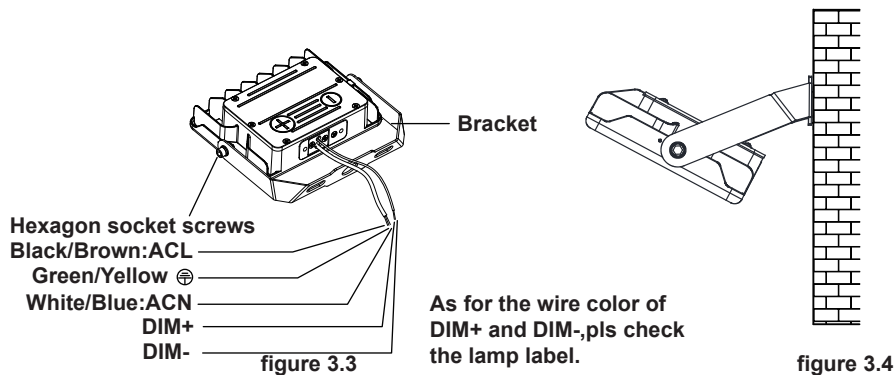

## Warning/Avertissement

MIN 75 °C SUPPLY CONDUCTORS.

THIS PRODUCT MUST BE INSTALLED IN ACCORDANCE WITH THE APPLICABLE INSTALLATION CODE BY A PERSON FAMILIAR WITH THE CONSTRUCTION AND OPERATION OF THE PRODUCT AND THE HAZARDS INVOLVED

LES FILS D'ALIMENTATION 75 °C MIN.

CCE PRODUIT DOIT ÊTRE INSTALLÉ SELON LE CODE D'INSTALLATION PERTINENT, PAR UNE PERSONNE QUI CONNAÎT BIEN LE PRODUIT ET SON FONCTIONNEMENT AINSI QUE LES RISQUES INHÉRENTS



## Notice For User

- Please turn off power before install or change assembly parts.
- The input voltage and lamps should be matched, after connecting the power line, Please make sure the wiring section is insulated.
- No-professionals, must not install and disassemble the lamps.

## TROUBLE SHOOTINGS

TROUBLES	CHECK POINTS
Flickering of the light	Turn off the power and turn on again in 3 minutes. If same phenomena occur, then call agencies.
Out of working	Please check the connection.

## Packaging

Box Type	Dimensions (Inches)	Pcs/Box	Net Weight	Gross Weight
Inner Box	10.82 X 2.95 X 12.20	1	3.30LBS	3.96LBS
Outer Box	18.54 X 12.79 X 11.61	6	19.84LBS	25.35LBS

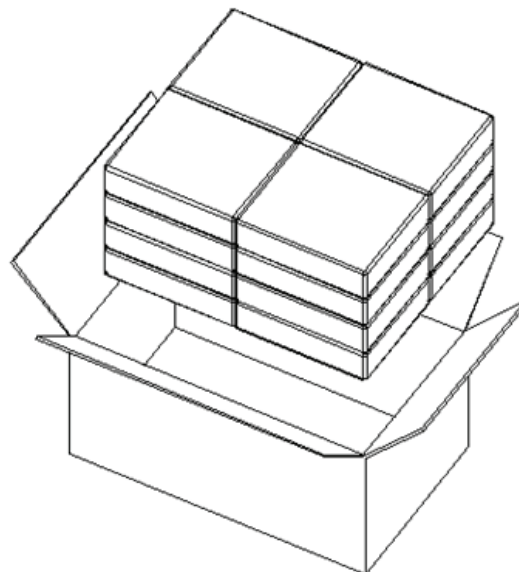

# LED FLOOD LIGHT



## Application



LED FLOOD LIGHT