



Nothing But LED’s LED UFO High-Bay is the newest and most feature rich product of 2023. Our LED UFO High-Bay fixture offers 150 Lumens per Watt for maximum savings and rebates. LED UFO High-Bay is built to last with surge protection, 113°F ambient temperature rating and IP65 rating for elimination of dust, moisture and airborne contaminants. The unique easy connect driver to optical assembly interface allows for quick and easy maintenance. Applications including warehousing, gymnasiums, manufacturing and outdoor canopies. Our High Bay is fully ready to integrate with most smart control systems.

Product Features

- Up to 150 Lumens per watt
- Wattage Adjustable
- Input Voltage 120-277Vac
- Optional Motion Sensor / Remote
- Optional emergency backup
- Beam Angle 120° Degree
- Up to 6KV surge protector
- G Hook Mount Included
- IP65 Rated
- UL & DLC listed
- 5 Year warranty

LED UFO HIGH BAY



SKU #	Model #	Wattage Adjustable	Lumens	CCT	Housing Color	Dimming	IP	Input Voltage	Certifications
1560252	BLT-HBF(150/120/100)W-50K80LV-SWC	100W/120W/150W	22500Lm	5000K	Black	0-10V	IP65	120-277Vac	UL & DLC
1560253	BLT-HBF(240/200/180)W-50K80LV-SWC	180W/200W/240W	36000Lm	5000K	Black	0-10V	IP65	120-277Vac	UL & DLC

SKU Number 1560252 Specifications

Parameter	Description	Value
General Performance	Model #	BLT-HBF(150/120/100)W-50K80LV-SWC
	Wattage Adjustable	100W / 120W / 150W
	Lumens	Up to 22500LM
	Lumen Efficacy	Up to 150LM/W
	Color Temperature	5000K
	CRI (Ra)	>80
Electrical	Beam Angle	120° Degree
	Diffuser Type	PC Diffuser
	Input Voltage	120-277Vac
	Frequency	50/60Hz
	Dimming	0-10V
	Power Factor	0.9
Physical	Driver Surge Protection	L/N-PE: 6kV, L-N: 4kV
	Flicker Percent	Flicker Free
	Operating Temperature	-40°C - 45°C
	LED Brand	E-Lite
	LED Type	SMD 2835
	LED QTY	224 Pcs
Qualification	Housing	Aluminum
	Housing Color	Black
Qualification	IP Rating	IP65
	Warranty	5 Year

SKU Number 1560253

Specifications

Parameter	Description	Value
General Performance	Model #	BLT-HBF(240/200/180)W-50K80LV-SWC
	Wattage Adjustable	180W / 200W / 240W
	Lumens	Up to 36000LM
	Lumen Efficacy	Up to 150LM/W
	Color Temperature	5000K
	CRI (Ra)	>80
	Beam Angle	120° Degree
Electrical	Diffuser Type	PC Diffuser
	Input Voltage	120-277Vac
	Frequency	50/60Hz
	Dimming	0-10V
	Power Factor	0.9
	Driver Surge Protection	L/N-PE: 6kV, L-N: 4kV
Physical	Flicker Percent	Flicker Free
	Operating Temperature	-40°C - 45°C
	LED Brand	E-Lite
	LED Type	SMD 2835
	LED QTY	336 Pcs
	Housing	Aluminum
	Housing Color	Black
Qualification	IP Rating	IP65
	Warranty	5 Year

LED UFO HIGH BAY



Correlated Color Temperature (CCT)

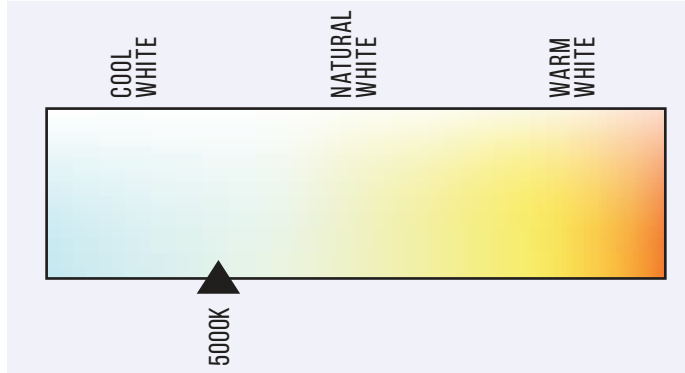

Accessories



Included
G Hook



Optional
Motion Sensor



Optional
Motion Sensor Remote
SKU: 151241

Dimensions

100W/120W/150W

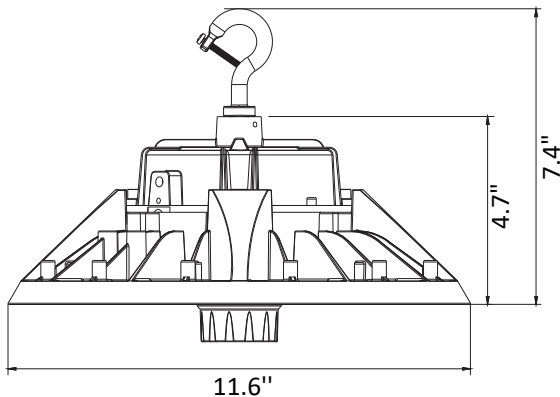

200W/240W

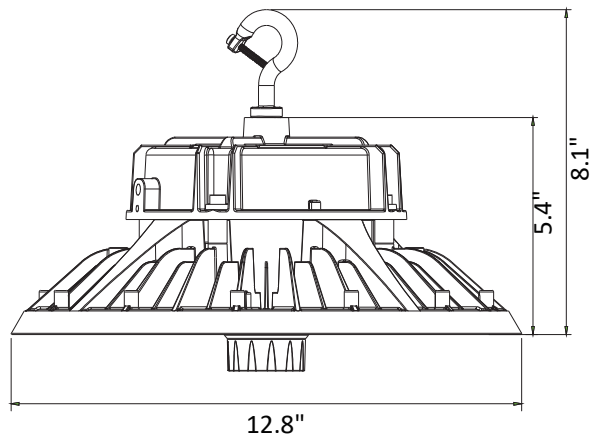

Photometric

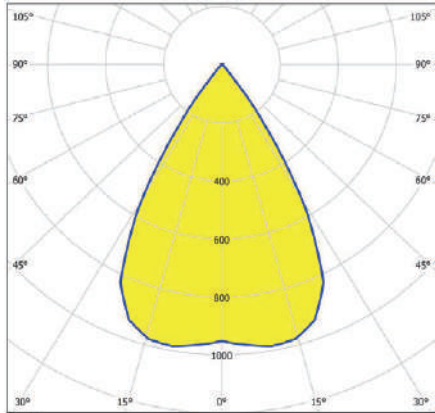

Beam angle: 60°

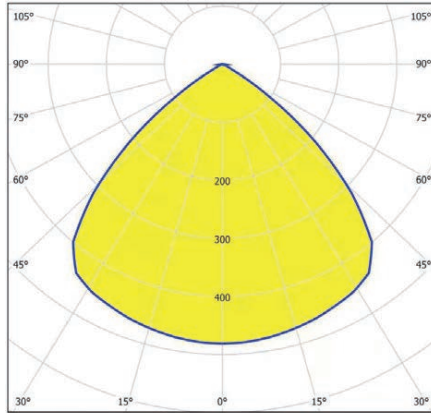

Beam angle: 90°

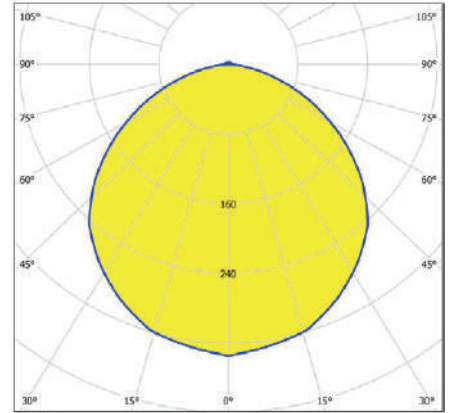

Beam angle: 120°

LED UFO HIGH BAY

Input Voltage
AC120-277V

G Hook Mount (Standard)

Wattage Adjustable
(150/120/100)W
(240/200/180)W
(310/270/240)W

Extra Reflector (optional)
Aluminum PC

Plugable Control
Daylight / Motion / PR sensor for optional

Lens
60°, 90°, 120° optional

Installation

Please read this manual carefully before using the product

CAUTION

RISK OF PRODUCT DAMAGE

Never connect components under load.

Do not mount or support these fixtures in a manner that can cut the outer jacket or damaged wire insulation. Unless individual product specifications deem otherwise: Never connect an LED product directly to dimmer packs, occupancy sensors, timing devices, or other control devices. LED fixtures must be powered directly off a switched circuit.

Unless individual product specifications deem otherwise: Do not restrict fixture ventilation. Allow for some volume of airspace around the fixture. Avoid covering LED fixtures with insulation, foam, or other material that will prevent convection or cooling.

Unless individual product specifications deem otherwise: Do not exceed fixtures' maximum ambient temperature.

Only use the fixture in its intended location.

LED products are polarity sensitive. Ensure proper polarity before installation.

Electrostatic Discharge (ESD): ESD can damage LED fixtures. Personal grounding equipment must be worn during all installation or servicing of the unit.

Do not touch individual electrical components as this can cause ESD, shorten lamp life, or alter performance. Some components inside the fixture may not be serviceable. If your unit requires service, stop using the unit immediately and contact an manufacture representative for assistance.

Changes or modifications not expressly approved by manufacturer will void the product warranty.

Always read the fixtures' complete installation instructions prior to installation for any additional fixture-specific warnings.

PACKAGE

1. LED UFO High Bay Light.
2. Installation Instruction.
3. Installation hardware.

HBF (Built-in Driver) Installation instructions

Suspended Installation

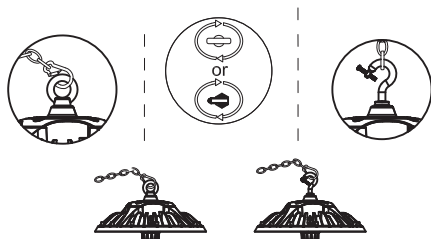

2. First fix the hook on the lamp (rotate clockwise) then connect the hook with the lock ring

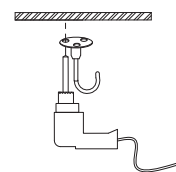

2. Use electric drill to bore a hole on the wall.

Installation

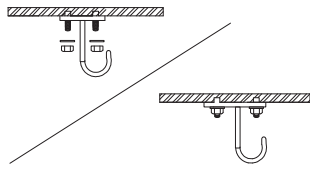

3. Fix the hanger on the wall with screws.

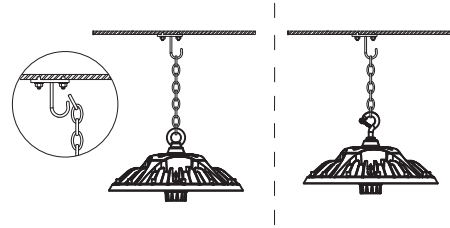

4. Fix one end of the chain to the wall, another end to the O/G hook from light, finish the installation.

Ceiling Installation

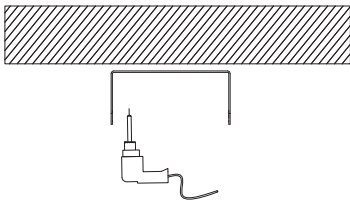

1. Use electric drill to bore a hole on the wall.

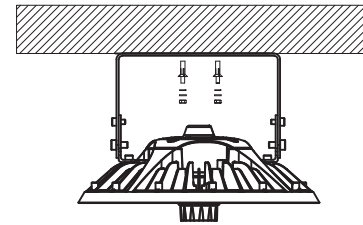

2. Install the expansion screw to the existing hole.

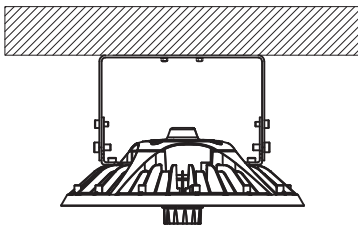

3. Fix the U bracket to the wall by nut, plain cushion, spring shim.

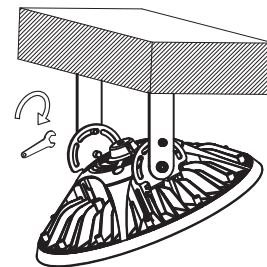

4. Use a wrench to reverse the hex nut and adjust the required angle.

HBF (External Driver) Installation instructions

Suspended Installation

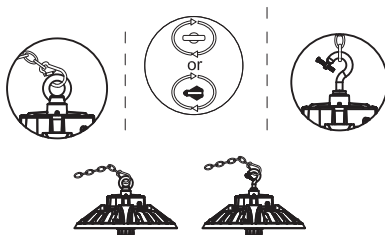

2. First fix the hook on the lamp (rotate clockwise) then connect the hook with the lock ring

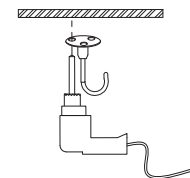

2. Use electric drill to bore a hole on the wall.

Installation

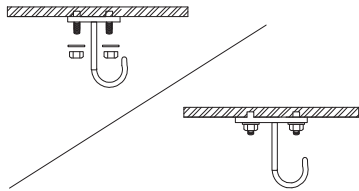

3. Fix the hanger on the wall with screws

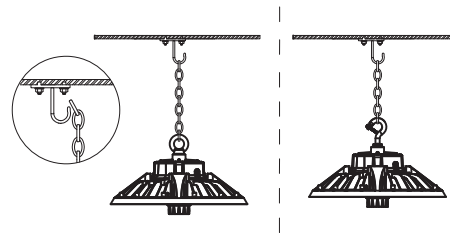

4. Fix one end of the chain to the wall, another end to the O/G hook from light, finish the installation.

Ceiling Installation

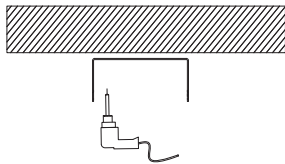

1. Use electric drill to bore a hole on the wall.

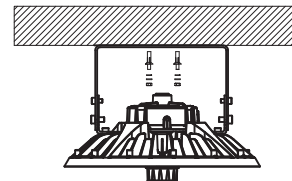

2. Install the expansion screw to the existing hole

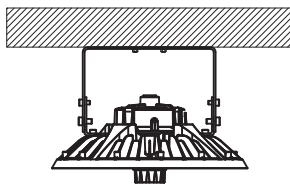

3. Fix the U bracket to the wall by nut, plain cushion, spring shim

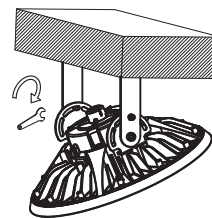

4. Use a wrench to reverse the hex nut and adjust the required angle.

TROUBLESHOOTING

Check that the line voltage at the fixture is correct. Refer to wiring directions.

Is the fixture grounded properly.

Be sure the photocell, if used, is functioning properly.

Installation

Wattage Adjustable

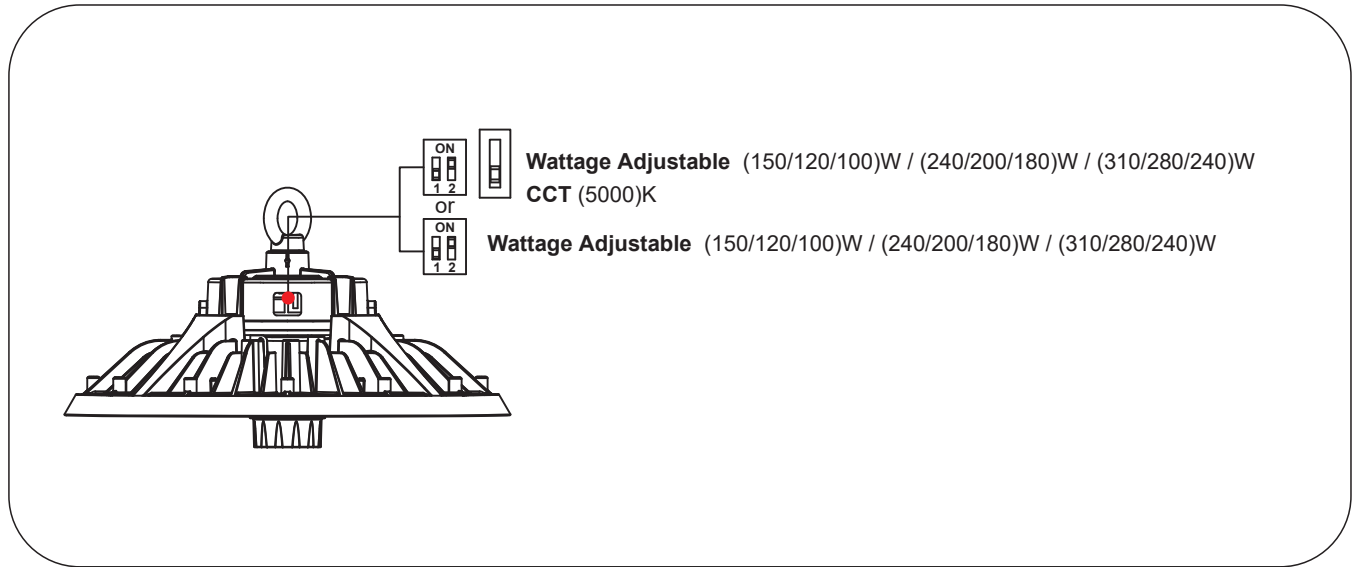

WIRING DIAGRAM

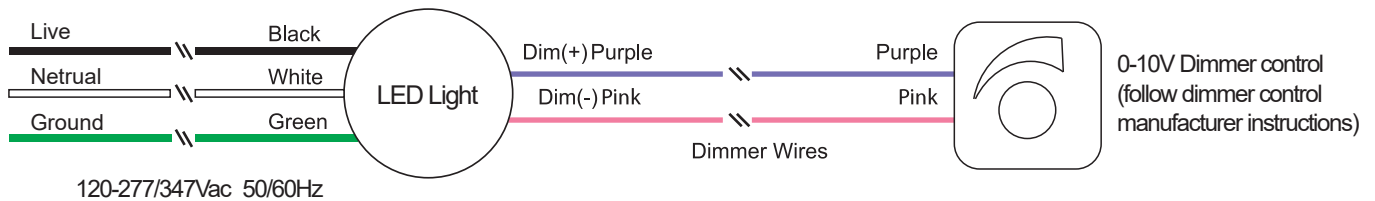

Upon receipt of fixture, thoroughly inspect for any freight damage. All damage should be reported to the delivery carrier. Compare the catalog description listed on the packing slip with the fixture label on the inside of the housing to be sure you have received the correct merchandise.

READ AND FOLLOW THESE SAFETY INSTRUCTIONS!

To reduce the risk of death, personal injury or property damage from fire, electric shock, falling parts, cuts/abrasions, and other hazards please read all warnings and instructions included with and on the fixture box and all fixture labels.

Before installing, servicing, or performing routine maintenance on this equipment, follow these general precautions.

Commercial installation, service and maintenance of luminaires should be performed by a qualified licensed electrician.

For Residential installation: If you are unsure about the installation or maintenance of the luminaires, consult a qualified licensed electrician and check your local electrical code.

Maintenance of the luminaires should be performed by person(s) familiar with the luminaires' construction and operation and any hazards involved. Regular fixture maintenance programs are recommended.

Installation

This fixture is intended to be connected to a properly installed and grounded UL listed junction box. It will occasionally be necessary to clean the outside of the refractor/lens. Refractor/lens should be washed in a solution of warm water and any mild, non-abrasive household detergent, rinsed with clean water and wiped dry. Should optical assembly become dirty on the inside, wipe refractor/lens and clean in above manner, replacing damaged gaskets as necessary.

DO NOT INSTALL DAMAGED PRODUCT! This luminaire has been properly packed so that no parts should have been damaged during transit. Inspect to confirm.

Any part damaged or broken during or after assembly should be replaced.

These instructions do not purport to cover all details or variations in equipment nor to provide every possible contingency to meet in connection with installation, operation, or maintenance. Should further information be desired or should particular problems arise which are not covered sufficiently for the purchaser's or owner's purposes, this matter should be referred to manufacturer

WARNING

RISK OF ELECTRIC SHOCK

Disconnect or turn off power before installation or servicing.

Verify that supply voltage is correct by comparing it with the luminaire label information.

Make all electrical and grounded connections in accordance with the National Electrical Code (NEC) and any applicable local code requirements.

All wiring connections should be capped with UL approved wire connectors.

CAUTION

RISK OF INJURY

Wear gloves and safety glasses at all times when removing luminaire from carton, installing, servicing or performing maintenance.

Avoid direct eye exposure to the light source while it is on.

WARNING

RISK OF BURN

Allow lamp/fixture to cool before handling. Do not touch enclosure, lens or light source.

Do not exceed maximum wattage marked on luminaire label.

Follow all manufacturer's warnings, recommendations and restrictions including but not limited to: driver type, mounting locations/methods, replacement and recycling.

Use only lamps that comply with ANSI standards.

CAUTION

RISK OF FIRE

Keep combustible and other materials that can burn, away from lamp/lens.

Do not operate in close proximity to persons, combustible materials, or substances affected by heat.

Packaging

SKU #.	Dimension	Qty.	Gross Weight	Net Weight
1560252	13.6 x 13.6 x 5.7	1 Pc/Box	6.0 LBS	4.9 LBS
1560253	15 x 15 x 5.7	1 Pc/Box	12.6 LBS	11.5 LBS

Application Image



LED UFO HIGH BAY



Application Image



LED UFO HIGH BAY

Warranty

5 Year Warranty