



Nothing But LED's Flood light is the most economical and newest 2022 model. Our Flood light offers high lumens per watt for maximum power savings and rebates from power companies. This flood light is ideal to replace Halogen lamps and comes with a U-Bracket mount. Our Flood light is an extremely cost effective solution, great for illuminating yards, driveways, signage and security applications.

Product Features

- Up to 160 lumens per watt
- Input Voltage 120-277Vac
- High Efficacy LumiLEDs
- Ultra thin sleek design
- Optional Screw-in Photocell
- Built-in U-Bracket Mount
- Heat resistant polycarbonate optical lens
- Die Cast Aluminum Bronze housing
- UL & DLC Listed
- 5 Year Warranty

LED FLOOD LIGHT



SKU #	Model #	Watt	Lumens	CCT	Photocell	Input Voltage	Certifications
1560237	BLT-S-G14-150WBT3A4-BR10SP50	150W	24000Lm	5000K	Optional Screw-in Photocell	120-277V	UL & DLC
1550903	BLT-S-G14-300WBT3A4-BR10SPFM50	300W	48000Lm	5000K		120-277V	UL & DLC

SKU #. 1560237 Specifications

Parameter	Description	Value
General Performance	Model #	BLT-S-G14-150WBT3A4-BR10SP50
	Wattage	150W
	Lumen	24000LM
	Lumen Efficacy	Up to 160LM/W
	Color Temperature	5000K
	CRI (Ra)	>80
	Beam Angle	155° x 90° (Type III)
Electrical	Input Voltage	120-277Vac
	Frequency	50/60Hz
	Dimming	1-10V Dimmable
	Power Factor	≥0.9
	Driver Surge Protection	L/N-PE: 6kV, L-N: 4kV
	Flicker Percent	<70%
Physical	Operating Temperature	Without Motion Sensor: -35°C TO 50°C; With Motion Sensor: -30°C TO 50°C
	Operating Humidity	5% -95% RH
	Storage Temperature	-40°C To 85°C
	Storage Humidity	5% - 95% RH
	LED Brand	Lumileds
	LED Type	SMD2835
	LED QTY	322 Pcs
	Housing	Die-cast aluminum
Housing Color	Bronze	
Qualification	IP Rating	IP65
	Warranty	5 Year

SKU #. 1550903

Specifications

Parameter	Description	Value
General Performance	Model #	BLT-S-G14-300WBT3A4-BR10SP50
	Wattage	300W
	Lumen	48000LM
	Lumen Efficacy	Up to 160LM/W
	Color Temperature	5000K
	CRI (Ra)	>80
	Beam Angle	155° x 90° (Type III)
Electrical	Input Voltage	120-277Vac
	Frequency	50/60Hz
	Dimming	1-10V Dimmable
	Power Factor	≥0.9
	Driver Surge Protection	L/N-PE: 6kV, L-N: 4kV
	Flicker Percent	<70%
Physical	Operating Temperature	Without Motion Sensor: -35°C TO 50°C; With Motion Sensor: -30°C TO 50°C
	Operating Humidity	5% -95% RH
	Storage Temperature	-40°C To 85°C
	Storage Humidity	5% - 95% RH
	LED Brand	Lumileds
	LED Type	SMD2835
	LED QTY	644 Pcs
	Housing	Die-cast aluminum
	Housing Color	Bronze
Qualification	IP Rating	IP65
	Warranty	5 Year

LED FLOOD LIGHT



Correlated Color Temperature (CCT)

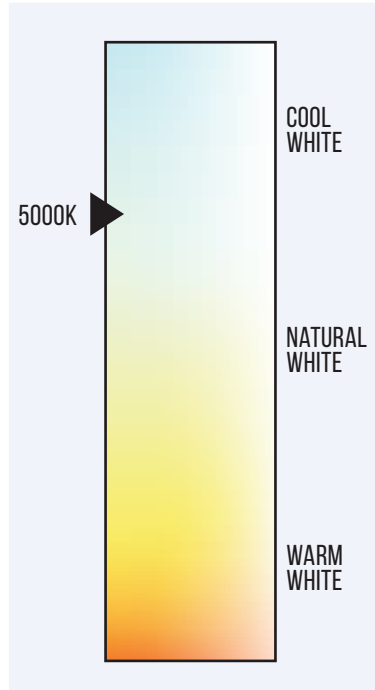

Dimensions

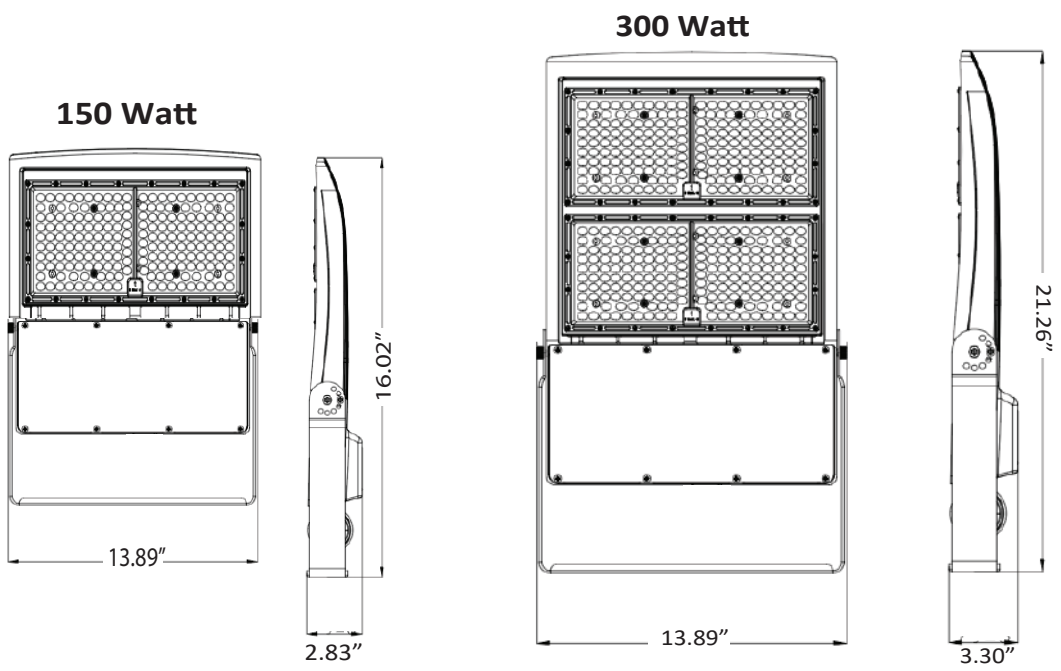

LED FLOOD LIGHT

Installation

Cautions:

1. Can not use the electric generator to test the LED light.
2. Please abide by related country, regional and local law and regulations when install this fixture.
3. To avoid electrical shock and damage, please do not install the lights in raining days.

Notices:

1. To prevent from electric shock or fire risk, the installation must be conducted by operator who have professional electrical knowledge.
2. Please wear gloves to avoid injury before installing lights.
3. During or after installation, if there are situations such as smoke, fire in the wires or lights, please turn off the power immediately and notify relevant personnel of an overhaul.
4. This light can be used for outdoor installation.

Instructions:

1. This product has dimming function.
2. 3 dimming functions are available in this shoebox light. (Optional)
 - (1). Constant current can be achieved by 1-10VDC dimming.
 - (2). PWM signal dimming.
 - (3). Variation of resistance unit dimming (Please choose the appropriate dimming way according to your needs. You can also choose not to use this function).
3. Choose the wire connection ways, dimming ways and installation ways according to your needs and the LED fixture purchased.

Wiring Diagram:

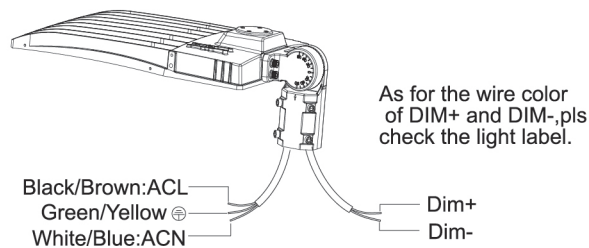

Optional Brackets and Installation Instructions:

There are 6 optional brackets for this fixture. The following is shoebox fixtures with different brackets

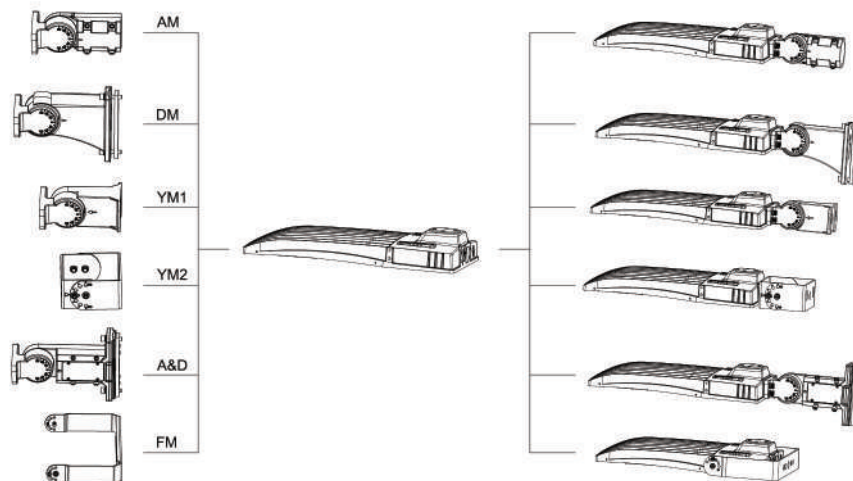

Installation

Installation Instructions with different brackets:

1. ADJUSTABLE FITTER MOUNTING (e=AM)

Step 1: Remove the bracket mounting screws on the fixture and run the wires through the bracket. (Figure 1)

Step 2: Install the bracket on the fixture. (Figure 2)



Figure 1

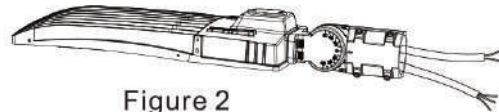

Figure 2

2. DIRECT MOUNTING (e=DM)

Step 1: Remove the bracket mounting screws on the fixture, open the side lid of bracket and run the wires through the bracket. (Figure 3)

Step 2: Install the bracket on the fixture, then cover the side lid and tighten it. (Figure 4)

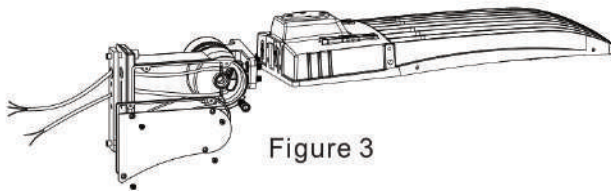

Figure 3

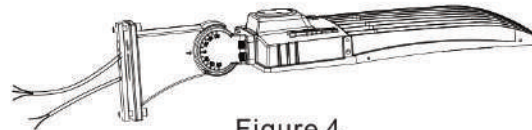

Figure 4

3. YOKE MOUNTING (e=YM1)

Step 1: Remove the bracket mounting screws on the fixture and run the wires through the bracket. (Figure 5)

Step 2: Install the bracket on the fixture. (Figure 6)

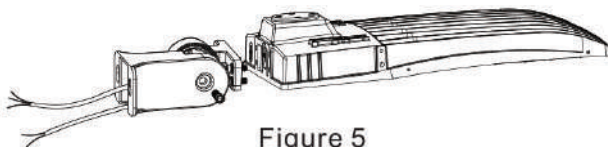

Figure 5

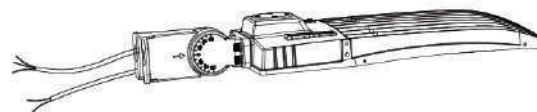

Figure 6

4. YOKE MOUNTING (e=YM2)

Step 1: Remove the bracket mounting screws on the fixture and run the wires through the bracket. (Figure 7)

Step 2: Install the bracket on the fixture. (Figure 8)

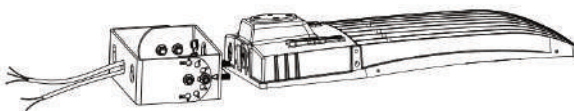

Figure 7

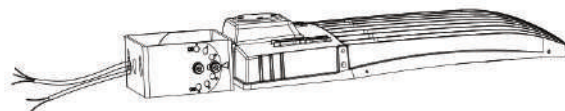

Figure 8

Installation

5. ADJUSTABLE FITTER MOUNTING & DIRECT MOUNTING (e=A&D)

Step 1: Remove the bracket mounting screws on the fixture, open the side lid of bracket and run the wires through the bracket. (Figure 9)

Step 2: Install the bracket on the fixture, then cover the side lid and tighten it. (Figure 10)

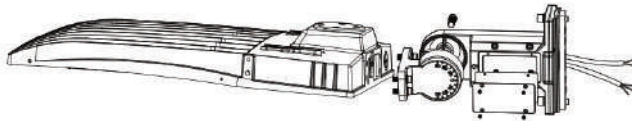

Figure 9

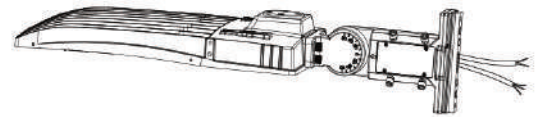

Figure 10

6. FLOOD MOUNTING (e=FM)

Step 1: First install two big screws. (Figure 11) Step 2: Install two small screws. (Figure 12)

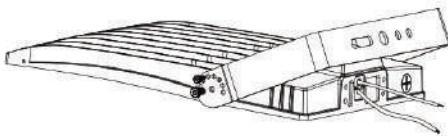

Figure 11

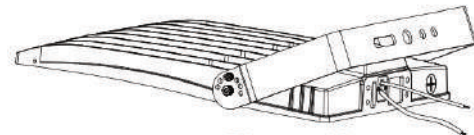

Figure 12

Installation of LED Lights

1. ADJUSTABLE FITTER MOUNTING (e=AM)

Step 1: Loosen the four bolts on AM bracket, connect the wires correctly, and pull the wires into the poles. (Figure 13)

Step 2: Place the bracket into the pole and lock the four bolts. (Figure 14)

Notice: Adjustable angle is 0-90° (Figure 13)

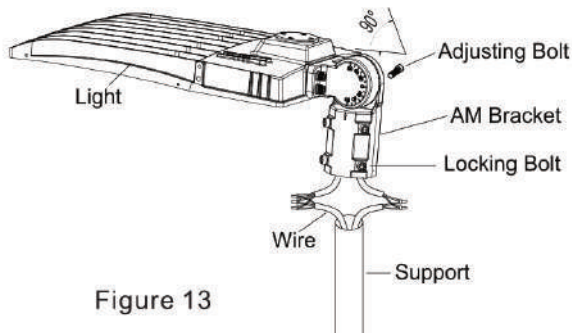

Figure 13

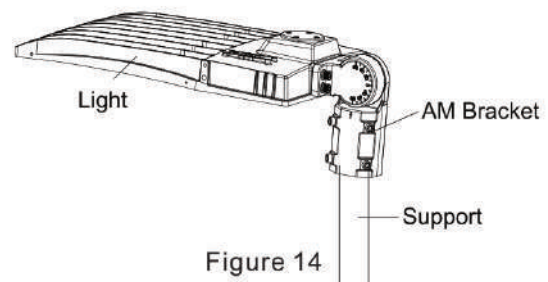

Figure 14

2. DIRECT MOUNTING (e=DM)

Step 1: Fix DM bracket to square pole with bolt, open the side lid of DM bracket, pull the wire into junction box, and connect the wire correctly. (Figure 15)

Step 2: Put the connected wire into the junction box, then cover the junction box. (Figure 16) Notice: Adjustable angle is 0-35° (Figure 15).

Same as round pole installation, please remember to remove the silicon plate when install the fixture in round pole (Figure 17)

Installation

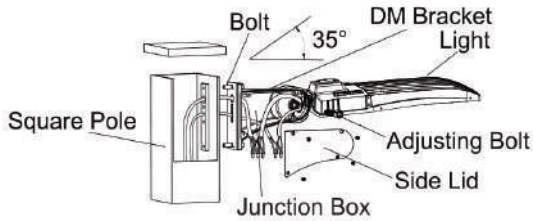

Figure 15

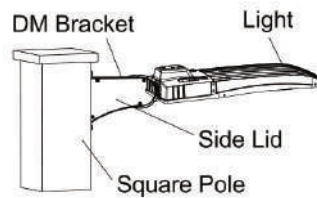

Figure 16

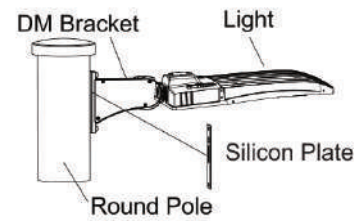

Figure 17

3. YOKE MOUNTING (e=YM1)

Step 1: Drill holes on the wall as shown. (Figure 18)

Step 2: Knock the expansion bolts into the wall.(Figure 19)

Step 3: Connect the fixture to the bracket and tighten the screws; connect the wires properly and put them into junction box. (Figure 20)

Notice: Adjustable angle is 0-90° (Figure 20)

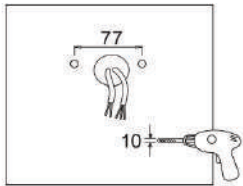

Figure 18

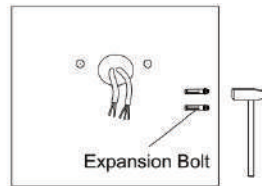

Figure 19

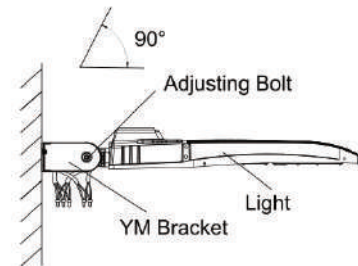

Figure 20

4. YOKE MOUNTING (e=YM2)

Step 1: Drill holes on the wall as shown. (Figure 21)

Step 2: Knock the expansion bolts into the wall.(Figure 22)

Step 3: Connect the fixture to the bracket and tighten the screws; connect the wires properly and put them into junction box.(Figure 23)

Notice: Adjustable angle is 0-90°(Figure 23)

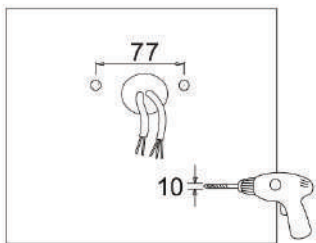

Figure 21

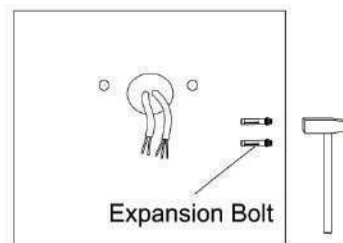

Figure 22

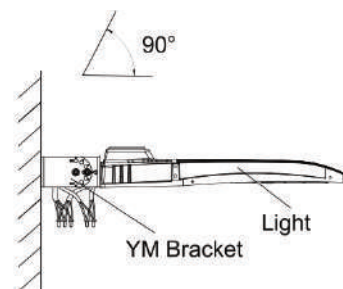

Figure 23

Installation

5. ADJUSTABLE FITTER MOUNTING & DIRECT MOUNTING (e=A&D)

5.1 ADJUSTABLE FITTER MOUNTING

Step 1: Remove the spare parts from A&D bracket. (Figure 24)

Step 2: Loosen the four bolts on A&D bracket, connect the wires correctly, and pull the wires into the poles. (Figure 25)

Step 3: Place the bracket into the pole and lock the four bolts. (Figure 25)

Notice: Adjustable angle is 0-90°(Figure 25)

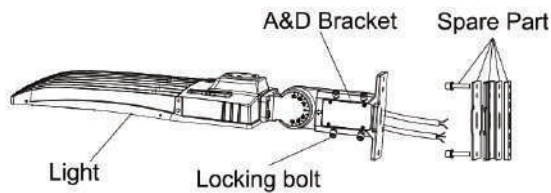

Figure 24

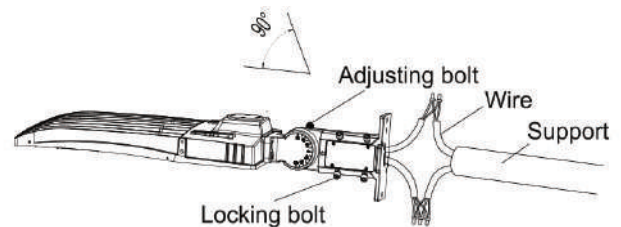

Figure 25

5.2 DIRECT MOUNTING

Step 1: Remove the four bolts from A&D bracket, remove the four rubber plugs from installation bar, put the four rubber plugs on the place where the four bolts were previously placed on the bracket for waterproof purpose(Figure 26)

Step 2: Fix A&D bracket to square pole with bolt, open the cover of A&D bracket junction box, pull the wire into bracket junction box, connect the wire properly and cover the junction box. (Figure 27)

Notice: Adjustable angle is 0-90°.(Figure 27)

Same as round pole installation, please remember to use the adapting plate for round pole installation (Figure 28)

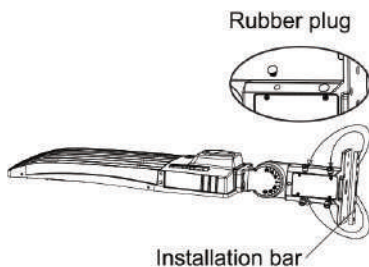

Figure 26

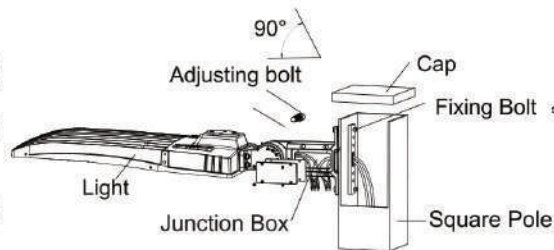

Figure 27

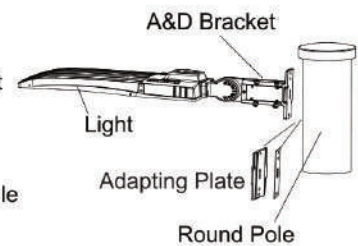

Figure 28

Installation

6. FLOOD MOUNTING (e=FM)

Install the mount to the fixture, tighten the mount and install the screws. Connect the fixture to the bracket and tighten the screws, connect the wires properly and put them into junction box (Figure 29)

Standard wire:
L/live wire: Black\Brown;
N/null wire: White\Blue;
Ground wire: Green\Yellow-green.

SUITABLE FOR WET LOCATIONS
MIN 75 °C SUPPLY CONDUCTORS, CAUTION - RISK OF FIRE
SUITABLE FOR OPERATION IN AMBIENT NOT EXCEEDING 50°C
INSTALL PHOTOCONTROL OR SHORTING PLUG.

CONVIENT AUX EMPLACEMENTS MOUILLÉS
LES FILS D'ALIMENTATION 75 °C MIN, ATTENTION – RISQUE D'INCENDIE.
PEUT ÊTRE UTILISÉ À UNE TEMPÉRATURE AMBIANTE N'EXCÉDANT PAS 50 °C
INSTALLER UNE CELLULE PHOTOÉLECTRIQUE OU UNE PRISE COURT-CIRCUITANTE.

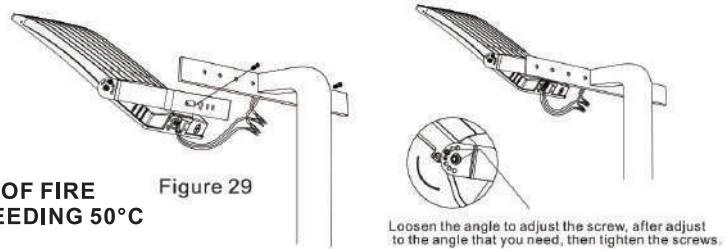

Instructions for Motion sensor(Figure 30)

Technical data	
Operating voltage	12±2V DC
Operating current	30mA
Output	DIM 0-10V
Stand-by power	<0.5W
Brightness	0%-100%/Quick setting:70%/80%/90%/100%
Sensitivity	20%/50%/75%/100%
Hold time	10s/1min/10min/30min
Daylight threshold	10Lux/30Lux/50Lux/100Lux/Disable
Stand-by time	1min/30min/60min/+∞
Stand-by dimming level	10%/20%/30%/50%
Microwave frequency	5.8GHz±75MHz
Microwave power	<0.5mW
Detection angle	150° (wall mounted) 360° (ceiling mounted)
Control line	Pink:+12V; Purple:DIM+; Gray:GND/DIM-
Mounting height	Max.15m(ceiling mounted)
Detection range	Max.∅15m(ceiling mounted) Max.20m(wall mounted)
Operating temperature	-30°C~+60°C
IP rating	IP20

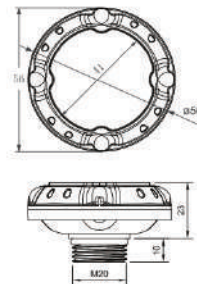
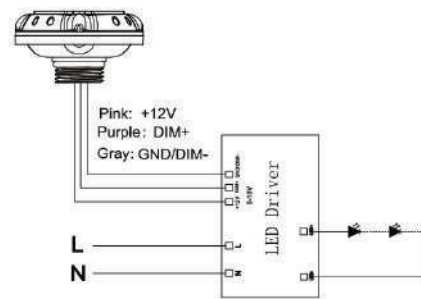
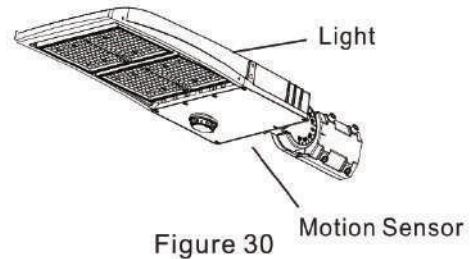

Note:
 Default setting: Brightness:100%, Hold time:1min, Stand-by dimming level:20%, Stand-by time:1min,
 Sensitivity:100%, Daylight:Disable.

Installation

Instructions for PIR sensor(Figure 31)

Technical data	
Operating voltage	12±2V DC
Operating current	30mA
Output	DIM 0-10V
Stand-by power	<0.5W
Brightness	0%-100%/Quick setting:70%/80%/90%/100%
Sensitivity	20%/50%/75%/100%
Hold time	10s/1min/10min/30min
Daylight threshold	10Lux/30Lux/50Lux/100Lux/Disable
Stand-by time	1min/30min/60min/+∞
Stand-by dimming level	10%/20%/30%/50%
Detection angle	30-120°
Control line	Pink:+12V; Purple:DIM+; Gray:GND/DIM-
Mounting height	Max.6m(ceiling mounted)
Detection range	Max.∅ 8m(ceiling mounted) Max.6m(wall mounted)
Operating temperature	-30°C~+60°C
IP rating	IP20

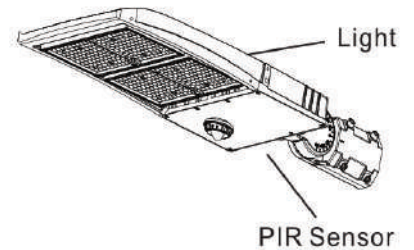
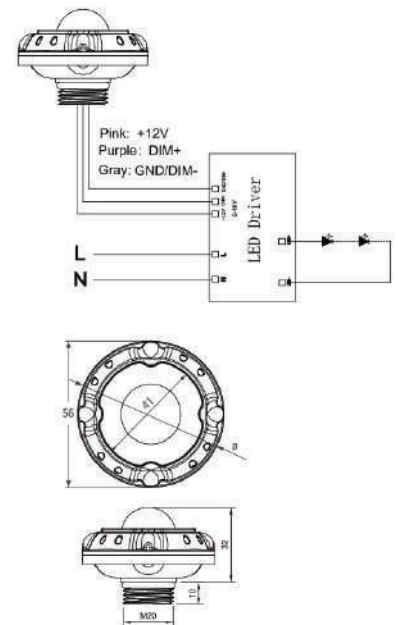

Figure 31



Note:

Default setting: Brightness:100%, Hold time:1min, Stand-by dimming level:20%, Stand-by time:1min, Sensitivity:100%, Daylight:Disable.

Instructions for Photocell

When the photocell function is required, photocell should be installed on the back of light; When it's not required, shorting cap should be installed on the back of light.(Figure 32)

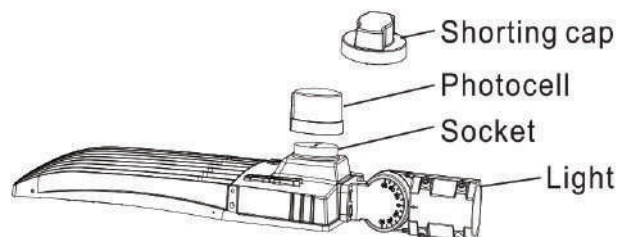

Figure 32

LED FLOOD LIGHT



Packaging

SKU	Dimension (Inches)	Qty	Net Weight	Gross Weight
1550903	27.56x15.15x6.10	1Pc	15.23LBS	17.66LBS
1560237	20.27 x 15.11 x 6.10	1Pc	10.14 LBS	11.90 LBS
1560596	27.55 x 15.15 x 6.10	1Pc	10.58 LBS	15.43 LBS

Application Images



Application Images



Warranty

5 Year Warranty