

# LED PARKING GARAGE LIGHT



Nothing But LED's Parking Garage Light fixture is fully-featured and the most innovative product of its kind. This new 2022 model offers CCT Adjustable options of 3000K, 4000K & 5000K. Because of its unique design, it offers 190 degree beam angle and more efficient light distribution. At Nothing But LED's we know every parking garage application is unique. Our Parking Garage fixtures offer high performance, energy-efficiency and the best technology to deliver parking garage lighting for optimum "sealability", safety and security.

## Product Features

- Up to 130 Lumens per watt
- CCT Adjustable 3000K/4000K/5000K
- Input voltage 120-277VAC
- Beam angle 190° Degree
- No UV or IR in the beam
- Easy to install and operate
- Light is soft and uniform, safe to eyes
- Optional Screw-in Motion Sensor
- 0-10V Dimmable
- Instant start, NO flickering, NO humming
- Green and eco-friendly without mercury
- Rating IP65
- UL & DLC listed
- 5 Years warranty

# LED PARKING GARAGE LIGHT



SKU #	Model #	Watt	Lumens	CCT	Housing	Dimming	Input Voltage	Certifications
1550948	BLT-PG07-60WBSP1DA1-abc30/40/50	60W	8400Lm	3K/4K/5K	White	0-10V	100-277Vac	UL & DLC
1550656	BLT-PG07-90WBSP1DA1-WH30/40/50	90W	12600Lm	3K/4K/5K	White	0-10V	100-277Vac	UL & DLC

## SKU Number 1550948 Specifications

Parameter	Description	Value
General Performance	Model #	BLT-PG07-60WBSP1DA1-abc30/40/50
	Wattage	60W
	Lumens	8400Lm
	Lumen Efficacy	Up to 140Lm/W
	Color Temperature	3000K / 4000K / 5000K
	CRI (Ra)	>80
	Beam Angle	190° Degree
	Diffuser Type	Stripe Lens
Electrical	Input Voltage	100-277Vac
	Frequency	50/60Hz
	Dimming	0-10V
	Power Factor	≥0.9
	Driver Surge Protection	L/N-PE: 2.5kV, L-N: 2.5kV
	Flicker Percent	<5%
Physical	Operating Temperature	Without Motion Sensor: -40°C TO 50°C; With Motion Sensor: -30°C TO 50°C
	Operating Humidity	10%-90% RH
	Storage Temperature	-40°C TO 75°C
	Storage Humidity	10%-90% RH
	LED Brand	Lumileds 2835
	LED Type	SMD2835 (0.5W)
	LED QTY	224 *2PCS
	Housing Material	Die-Cast Aluminum
Housing Color	White	
Qualification	IP Rating	IP65
	Warranty	5 Years

# LED PARKING GARAGE LIGHT

SKU Number 1550656

## Specifications

Parameter	Description	Value
General Performance	Model #	BLT-PG07-90WBSP1DA1-WH30/40/50
	Wattage	90W
	Lumens	12600Lm
	Lumen Efficacy	Up to 140Lm/W
	Color Temperature	3000K / 4000K / 5000K
	CRI (Ra)	>80
	Beam Angle	190° Degree
	Diffuser Type	Stripe Lens
Electrical	Input Voltage	100-277Vac
	Frequency	50/60Hz
	Dimming	0-10V
	Power Factor	≥0.9
	Driver Surge Protection	L/N-PE: 6kV, L-N: 6kV
	Flicker Percent	<5%
Physical	Operating Temperature	Without Motion Sensor: -40°C TO 50°C; With Motion Sensor: -30°C TO 50°C
	Operating Humidity	10%-90% RH
	Storage Temperature	-40°C TO 75°C
	Storage Humidity	10%-90% RH
	LED Brand	Lumileds 2835
	LED Type	SMD2835 (0.5W)
	LED QTY	280 *2PCS
	Housing Material	Die-Cast Aluminum
Housing Color	White	
Qualification	IP Rating	IP65
	Warranty	5 Years

# LED PARKING GARAGE LIGHT



## Correlated Color Temperature (CCT)

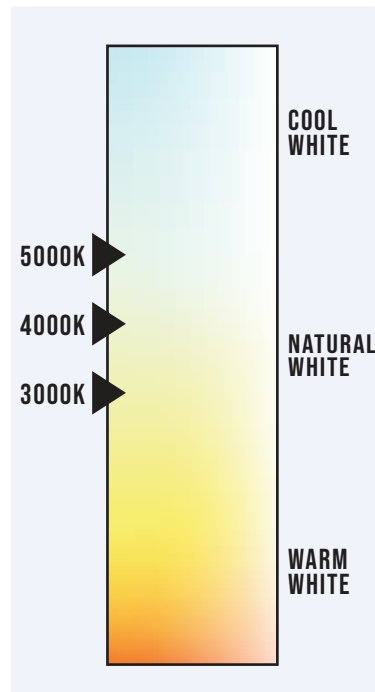

## Dimensions

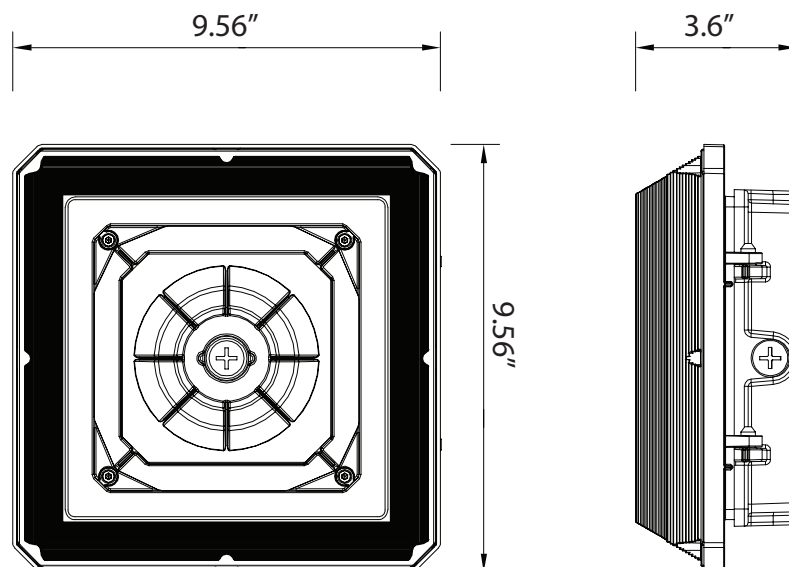



# LED PARKING GARAGE LIGHT

## Installation

### Cautions:

1. Can not use the electric generator to test the LED light .
2. Please abide by related country, regional and local law and regulations when install this fixture.
3. Please turn off the power before installation or maintenance.
4. Proper earth grounding is required to ensure safety.

### Notice:

1. To avoid possibility of electrical shock or fire, the installation personnel must have professional electric knowledge.
2. Please wear gloves to avoid injury before installation.
3. If any smoke or spark of the wire happened, please turn off the power immediately and notify relevant personnel.

### Attention:

1. Please check if there is any damage during shipping. If so, please contact manufacturer timely.
2. Please read the installation instruction carefully to check whether all the accessories are complete. After confirmation, then install the fixture according to installation steps.

### Wiring Diagram:

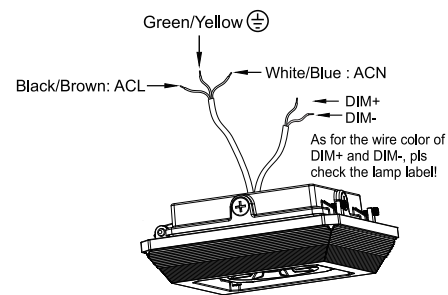

### Special functions instruction:

#### 1. Color temperature adjustable

1. The color temperature of the lamp turns to 3000K when the DIP switch is set to 3K.
2. The color temperature of the lamp turns to 4000K when the DIP switch is set to 4K.
3. The color temperature of the lamp turns to 5000K when the DIP switch is set to 5K.

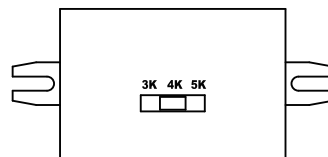

### ☑ Installation Method I :

1. Disassemble the driver box cover by loosen the two screws on the driver box; Figure 1-1
2. Loosen the 3/4 plug on the driver box cover by screwdriver; Figure 1-2
3. Fix the driver box cover on the 3/4 tube; Figure 1-3
4. Insert the mounting hole of radiator horizontally to the shaft of driver cover; Figure 1-4
5. Connect the wires properly. If the fixture is equipped with sensor, adjust the sensor settings as per your demand. Take relevant waterproof measures after finished wiring ; Figure 1-5
6. Turn the radiator up then cover the driver box ; Figure 1-6
7. Lock the two cap screws, then installation is finished; Figure 1-7

# LED PARKING GARAGE LIGHT

## Installation

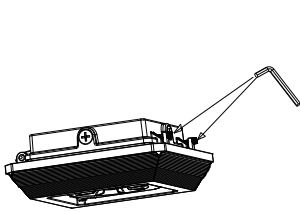

Figure 1-1

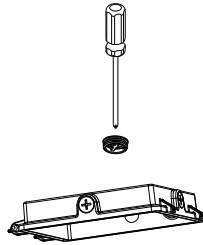

Figure 1-2

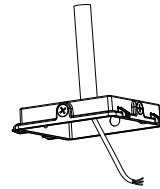

Figure 1-3

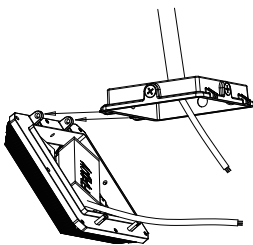

Figure 1-4

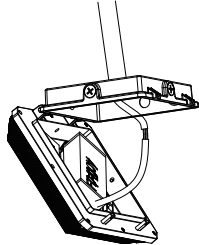

Figure 1-5

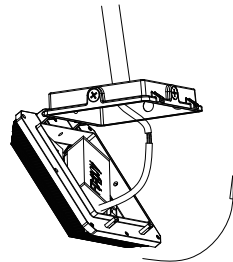

Figure 1-6

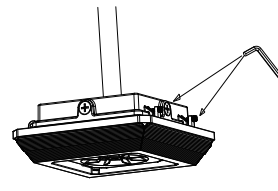

Figure 1-7

### ☑ Installation Method II :

1. Disassemble the driver box cover by loosening the two screws on the driver box; Figure 2-1
2. Loosen the 3/4 plug on the driver box cover by screwdriver; Figure 2-2
3. Drill the holes on the ceiling accordingly to fit the plate; Figure 2-3
4. Fix the driver box cover on the ceiling; Figure 2-4
5. Insert the mounting hole of radiator horizontally on the shaft of driver cover; Figure 2-5
6. Connect the wires properly. If the fixture is equipped with sensor, adjust the sensor settings as per your demand. Take relevant waterproof measures after finished wiring ; Figure 2-6
7. Turn the radiator up then cover the driver box ; Figure 2-7
8. Lock the two cap screws, then installation is finished ; Figure 2-8

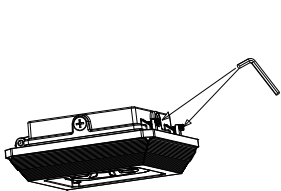

Figure 2-1

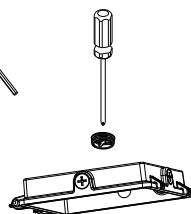

Figure 2-2

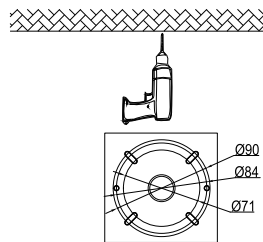

Figure 2-3

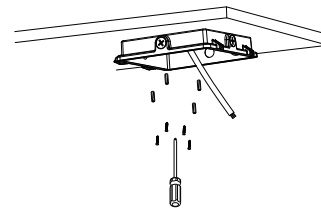

Figure 2-4

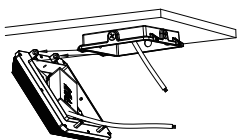

Figure 2-5

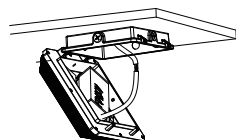

Figure 2-6

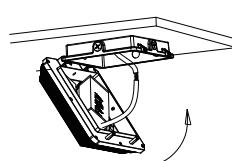

Figure 2-7

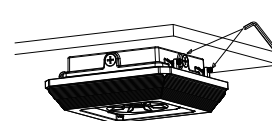

Figure 2-8

# LED PARKING GARAGE LIGHT

## Installation

### Instructions for Motion sensor(Figure 3)

Technical data	
Operating voltage	12±2V DC
Operating current	30mA
Output	DIM 0-10V
Stand-by power	<0.5W
Brightness	0%-100%/Quick setting:70%/80%/90%/100%
Sensitivity	20%/50%/75%/100%
Hold time	10s/1min/10min/30min
Daylight threshold	10Lux/30Lux/50Lux/100Lux/Disable
Stand-by time	1min/30min/60min/+∞
Stand-by dimming level	10%/20%/30%/50%
Microwave frequency	5.8GHz±75MHz
Microwave power	<0.5mW
Detection angle	150° (wall mounted) 360° (ceiling mounted)
Control line	Pink:+12V; Purple:DIM+; Gray:GND/DIM-
Mounting height	Max.15m(ceiling mounted)
Detection range	Max.∅15m(ceiling mounted) Max.20m(wall mounted)
Operating temperature	-30°C~+60°C
IP rating	IP20

**Note:**

Default setting: Brightness:100%, Hold time:1min, Stand-by dimming level:20%, Stand-by time:1min, Sensitivity:100%, Daylight:Disable.

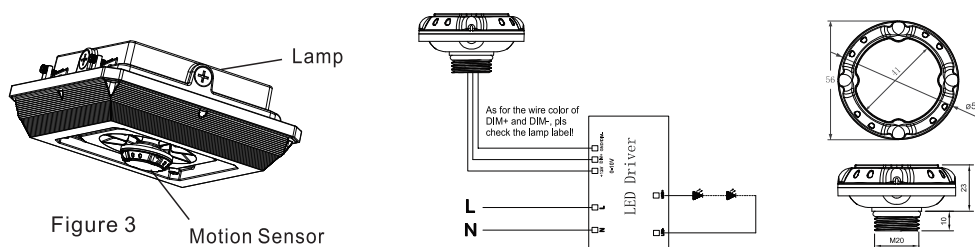

# LED PARKING GARAGE LIGHT

## Installation

### Instructions for PIR sensor(Figure 4)

Technical data	
Operating voltage	12±2V DC
Operating current	30mA
Output	DIM 0-10V
Stand-by power	<0.5W
Brightness	0%-100%/Quick setting:70%/80%/90%/100%
Sensitivity	20%/50%/75%/100%
Hold time	10s/1min/10min/30min
Daylight threshold	10Lux/30Lux/50Lux/100Lux/Disable
Stand-by time	1min/30min/60min/+∞
Stand-by dimming level	10%/20%/30%/50%
Detection angle	30-120°
Control line	Pink:+12V; Purple:DIM+; Gray:GND/DIM-
Mounting height	Max.6m(ceiling mounted)
Detection range	Max.∅ 8m(ceiling mounted) Max.6m(wall mounted)
Operating temperature	-30°C~+60°C
IP rating	IP20

**Note:**

Default setting: Brightness:100%, Hold time:1min, Stand-by dimming level:20%, Stand-by time:1min, Sensitivity:100%, Daylight:Disable.

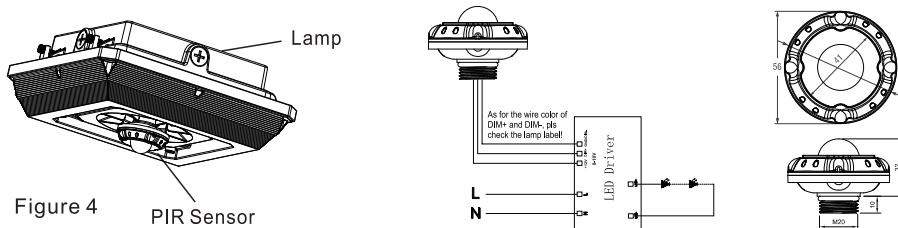

### Warning / Avertissement

MIN 90 °C SUPPLY CONDUCTORS

THIS PRODUCT MUST BE INSTALLED IN ACCORDANCE WITH THE APPLICABLE INSTALLATION CODE BY A PERSON FAMILIAR WITH THE CONSTRUCTION AND OPERATION OF THE PRODUCT AND THE HAZARDS INVOLVED.

LES FILS D'ALIMENTATION 90 °C MIN

CE PRODUIT DOIT ÊTRE INSTALLÉ SELON LE CODE D'INSTALLATION PERTINENT, PAR UNE PERSONNE QUI CONNAÎT BIEN LE PRODUIT ET SON FONCTIONNEMENT AINSI QUE LES RISQUES INHÉRENTS

# LED PARKING GARAGE LIGHT

## Notice For User

- Please turn off power before install or change assembly parts.
- The input voltage and lamps should be matched, after connecting the power line, Please make sure the wiring section is insulated.
- Non-professionals, must not install and disassemble the lamps.

Troubles	Check Points
Flickering of the light	Turn off the power and turn on again in 3 minutes. If same phenomena occur, then call agencies.
Out of working	Please check the connection.

## Packaging

	Size	Qty/Carton	Net Weight	Gross Weight
Inner Box	11.02 x 5.11 x 11.02	1Pcs	5.07 LBS	5.51 LBS
Outer Box	21.06 x 11.61 x 22.83	8Pcs	40.56 LBS	46.73 LBS

Tolerance of Carton Size:  $\pm 15$  MM, Tolerance of Weight:  $\pm 10\%$ .

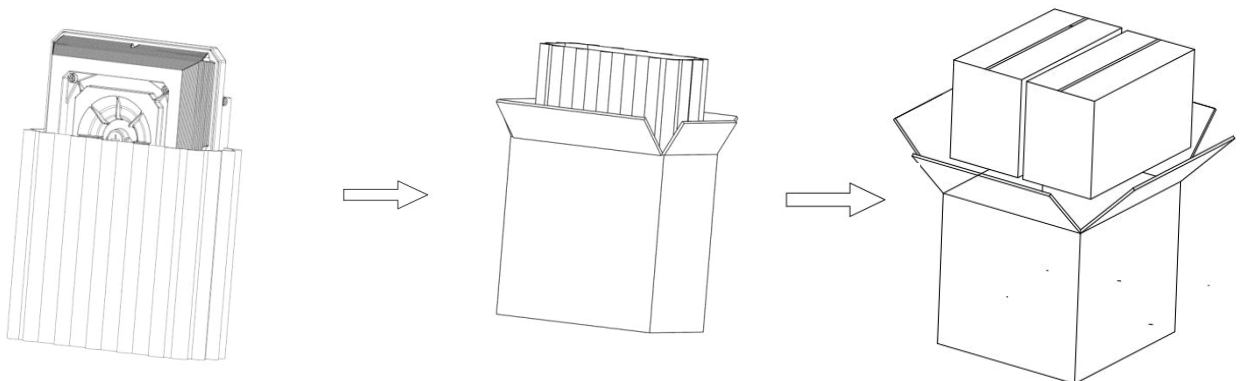

# LED PARKING GARAGE LIGHT



## Application Picture

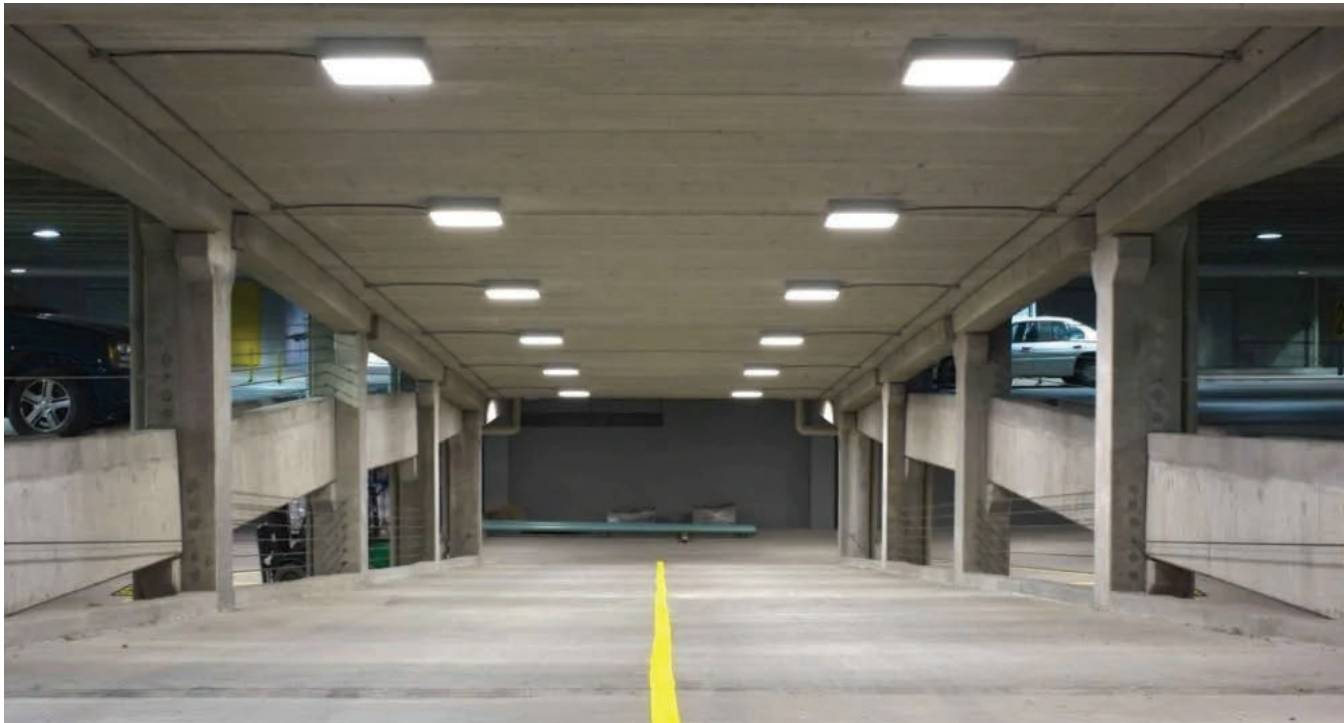

## Warranty

5 Years Warranty