



Nothing But LED's Retrofit Flat Head Corn Bulb high wattage LED retrofits are designed to reduce the power consumed, in fixtures traditionally used with metal halide or high-pressure sodium lamps, while still producing a high Lumen output. This 2022 version has a noiseless fan and it's the smallest, and shortest of its kind to fit such a wide range of fixtures. Suitable for use in enclosed fixtures, these high output LEDs are an excellent choice for post top lights, shoebox fixtures and other HID fixtures. The rotatable base allows you to aim the light where you need it. With 115° degree beam angle it saves 20-30% energy compared to a 360 bulb.

Product Features

- Up to 111 lumens per watt
- Wattage Adjustable
- Input voltage 120-277Vac
- 4KV built-in surge protector
- Can safely be used in enclosed fixtures
- IP64 dust proof rating
- Built-in Noise less High quality fan for best heat dissipation
- Big heat sink, With fan
- Fits many different fixtures to replace traditional lamps
- Direct replacement for Metal Halide, easy installation
- UL & DUL certificate
- 5 Year warranty

FLAT HEAD CORNCOB BULB



SKU #	Model #	Wattage Adjustable	Lumens	CCT	Input Voltage	Housing	Dimming	Certifications
1550916	BLT-CLH01B-115WJ3A1-E57K	75W/95W/115W	12824Lm	5700K	120-277V	Black	0-10V	UL & DLC

SKU Number 1550916 Specifications

Parameter	Description	Value
General Performance	Model #	BLT-CLH01B-115WJ3A1-E57K
	Wattage	75W / 95W / 115W
	Lumen	Up to 12824LM
	Lumen Efficacy	Up to 111LM/W
	Color Temperature	5700K
	CRI (Ra)	>79
	Beam Angle	115° Degree
	Diffuser Type	Type III
Electrical	Input Voltage	120-277Vac
	Frequency	50/60Hz
	Dimming	0-10V
	Power Factor	≥0.9
	Driver Surge Protection	L-N: 4kV
	Flicker Percent	<100%
Physical	Operating Temperature	-40°C to 50°C
	Operating Humidity	20%-70% RH
	Storage Temperature	-40°C TO 80°C
	Storage Humidity	10%-75% RH
	LED Brand	Bridgelux
	LED Type	SMD3030
	LED QTY	196 PCS
	Housing	PC + Aluminum
	Housing Color	Black
	IP Rating	DAMP (IP64)
Qualification	Warranty	5 Years

FLAT HEAD CORNCOB BULB

Correlated Color Temperature (CCT)

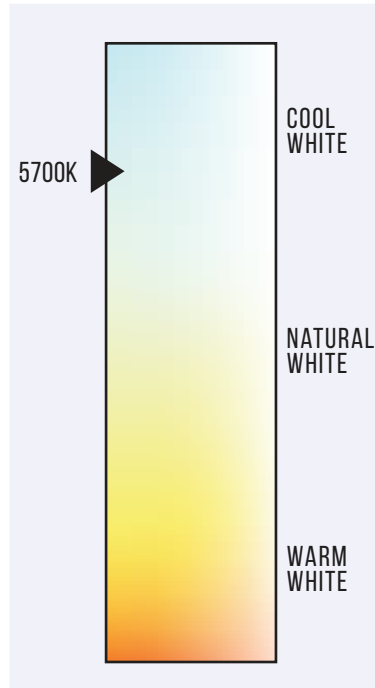

Dimensions

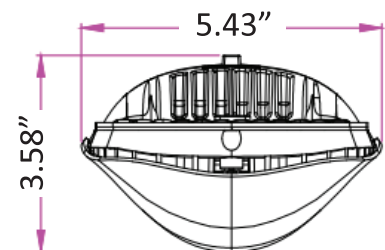
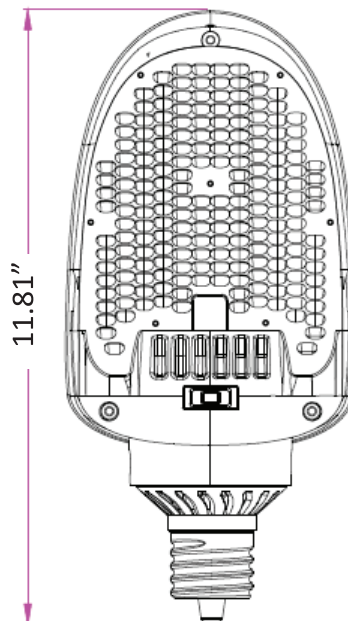
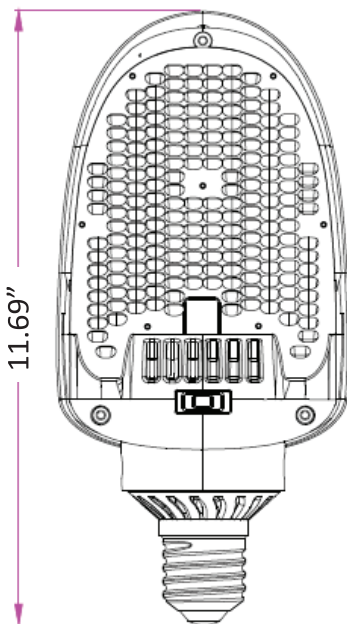

FLAT HEAD CORNCOB BULB



Photometric Result

Luminous Intensity Distribution Curve

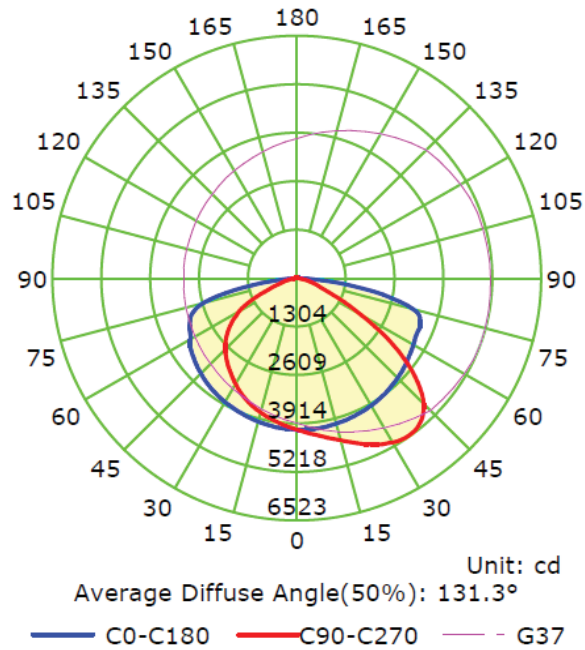

The Average Illuminance Effective Figure

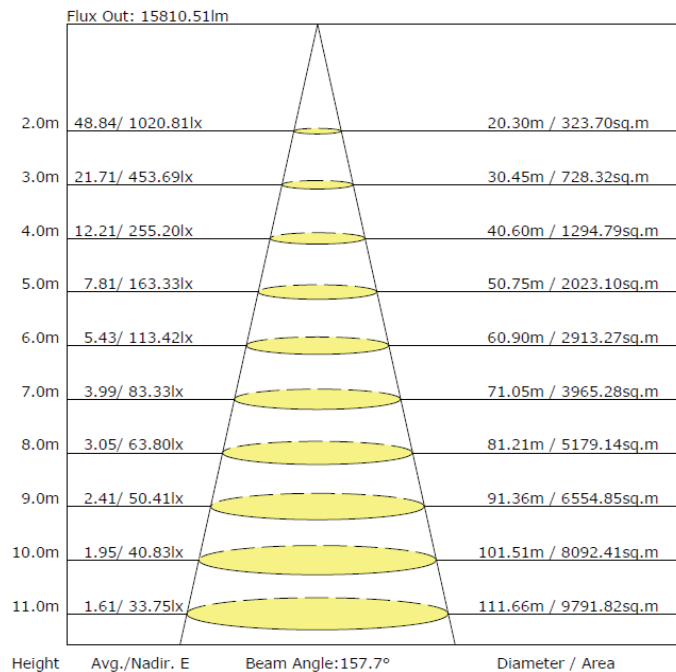

FLAT HEAD CORNCOB BULB

Installation

Do not use any electric generator to test the LED lamp. Please avoid using the led lamp in environment where there is smoke, sulfur, and corrosive substances. But if it's used in such environment, make sure the led lamp is well protected by an enclosed lampshade with dimension no less than below size, and materials made up of glass, semi-glass, or semi-metallic. There should be no covering on the surface of the lampshade to block heat dissipation.



Power(W)	27	36	54A1	54A2	75	95	115
Volume (CM)	34*20*20	38*20*20	40*20*20	42*21*21	42*23*23	44*24*24	44*26*26

Installation

PRODUCT FEATURES:

- Segmented wattage adjustable available
- Bridgelux chip
- Two types of lens optional, Type III: 90*150 Degree, or Type V: 90*150 Degree.
- Big heat sink, NO fan for 27W and 54WA2,36W-115W with fan.
- Internal driver, input voltage AC120-277V, 0-10V dimming.
- New Style driver with high efficient and wide-range input
- Long lifespan and good heat dissipation.
- Direct replacement for Metal Halide, easy Installation.
- Fits many different fixtures to replace traditional lamps.
- Operating ambient temperature can up to 50 degree.
- Lamp base can be rotatable to make sure the luminous direction of led area lamp is consistent with the outside fixture.

APPLICATION:

LED area lamp make it simple to replace: parking lot lighting, shoebox lighting, street lighting, flood lighting, wall pack lighting, and canopy lighting etc.

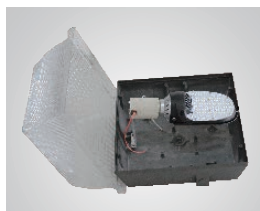
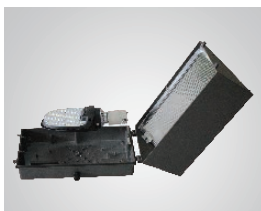

Installation

Installation Instructions:

Warning: Please make sure the power is off before installation.

1. Turn off the power.
2. Remove the original lamps like CFL, MHL, or HPS, etc., see Figure (1)(2)
3. Take out the LED area lamp and screw it on. After the LED area lamp is well tightened, adjust the lamp base slightly to make sure its luminous direction is consistent with the outside fixture, see Figure(3). Figure (4) :AC internal driver, (Note: Pls make sure to take off the ballast before installing LED area lamp, otherwise the ballast will produce the resonance of high voltage and makes LED area lamp breakdown.)
4. A safety rope is provided, hook it onto the safety hook on the light. see Figure (5).
5. A wattage switch is installed on the front surface of the led area lamp to help adjusting the brightness of the lamp, see Figure(6).
6. Lamp wattage can be adjusted by switch, see Figure(6)
7. Turn on the power. (Finished !)

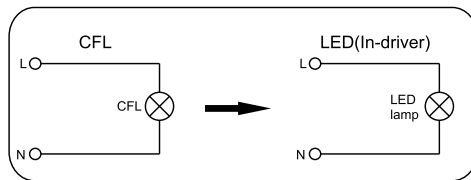

Figure(1)

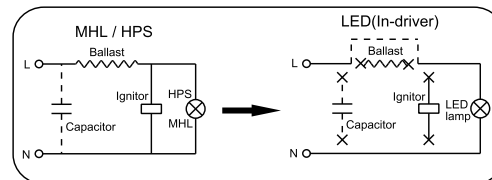

Figure(2)

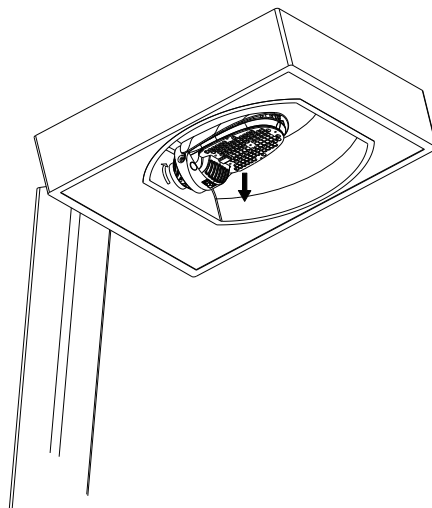

Figure(3)

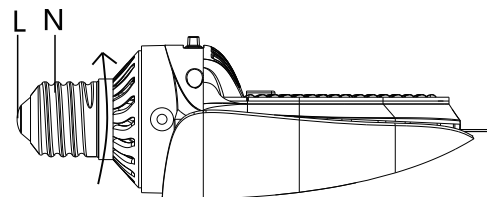

Figure(4)

Installation

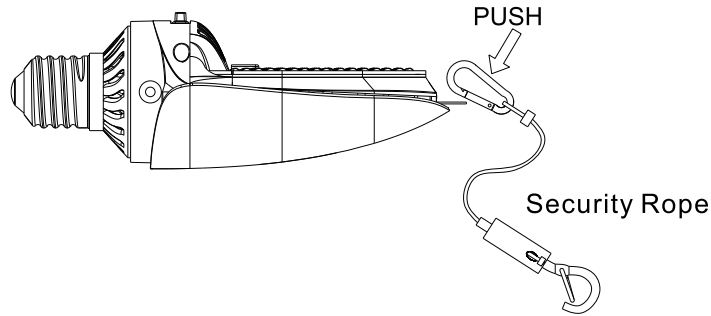

Figure(5)

S = Segmented wattage adjustable

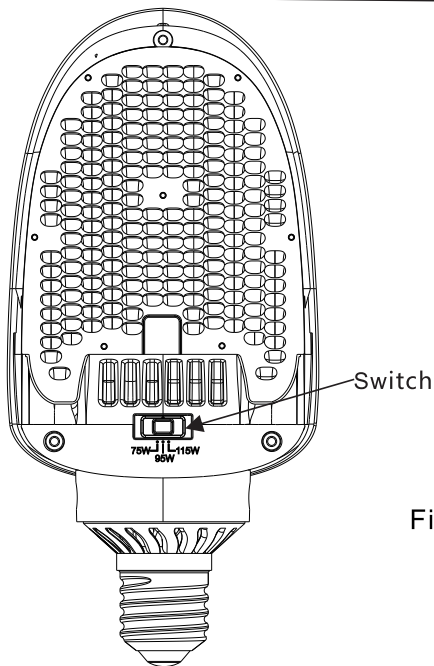

Rated wattage	Adjustable Wattage
27W	12W 18W 27W
36W	18W 27W 36W
54W	36W 45W 54W
75W	54W 63W 75W
95W	63W 75W 95W
115W	75W 95W 115W

Figure(6)

WARNING:

THIS DEVICE IS NOT INTENDED FOR USE WITH EMERGENCY EXITS ADDED WEIGHT OF THE DEVICE MAY CAUSE INSTABILITY OF A FREE-STANDING PORTABLE LUMINAIRE USE ONLY WITH A PORTABLE TABLE LUMINAIRE THAT IS PROVIDED WITH A SHADE.

AVERTISSEMENT:

NE CONVIENT PAS AUX SORTIES DE SECOURS LE DISPOSITIF CONSTITUE UN POIDS SUPPLEMENTAIRE CE QUI PEUT CAUSER L'INSTABILITE D'UN LUMINAIRE PORTATIF AUTONOME UTILISER UNIQUEMENT AVEC UNE LAMPE DE TABLE DOTEE D'UN ABAT-JOUR.

FLAT HEAD CORNCOB BULB

Packaging

Box Type	Size	Qty/Carton	Neight Weight	Gross Weight
Inner Box	13.38 x 6.29 x 4.33	1	2.77 LBS	3.19 LBS
Outer Box	26 x 14.17 x 9.65	8	22.26 LBS	27.77 LBS

Tolerance of Outer Carton Size: ± 15 MM, Tolerance of Weight: $\pm 10\%$.

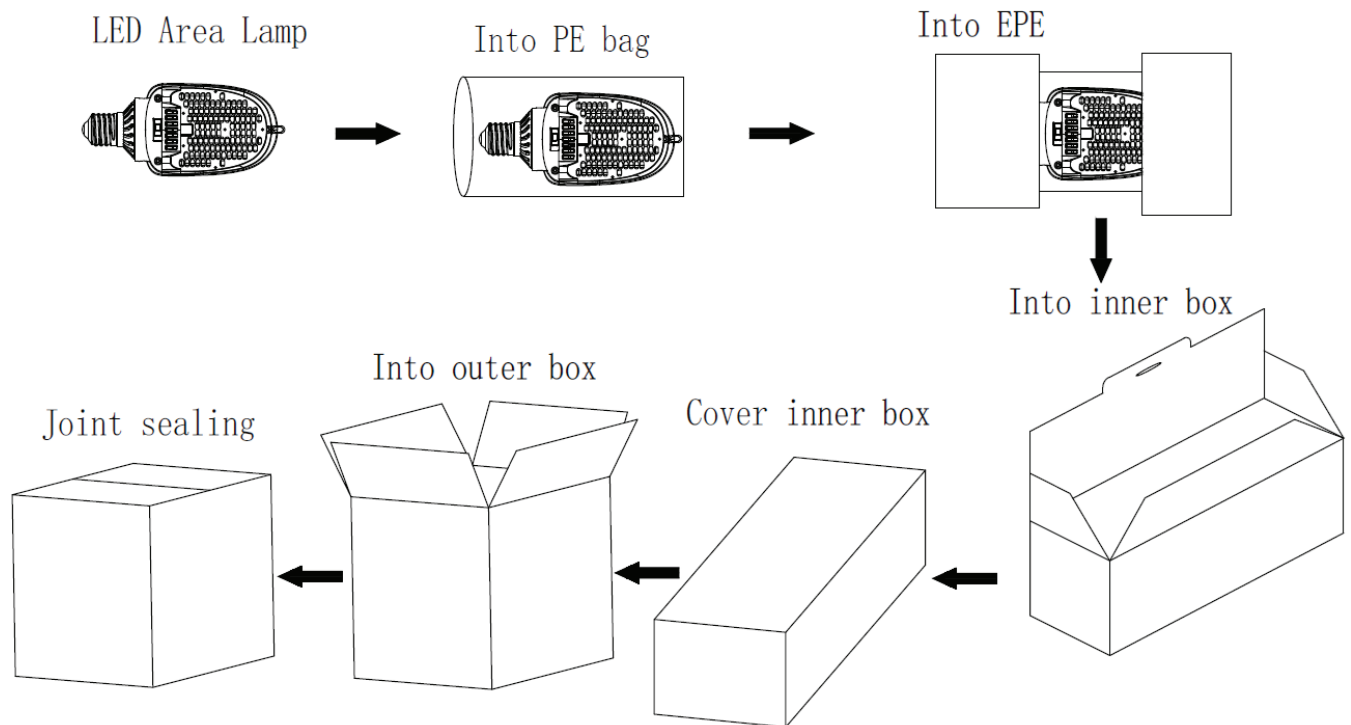

Warranty

5 Year warranty

FLAT HEAD CORNCOB BULB



Application Images



LED CORNCOB BULB