

LED WALL PACK



Our wall pack is the newest, most innovative and feature rich product of 2021. It offers three wattages selection with energy-efficient LED technology. LED wall pack comes with Built-in photocell. LED wall pack luminaires comes with die cast aluminum housings and a polycarbonate lens to stand up for many years of punishing environmental conditions.

Product Features

- Durable die-cast aluminum housing
- Built-in photocell
- Enclosure provides a water-tight seal making it suitable for outdoor application
- Integral LED driver (60W isolated driver and 120W non-isolated driver), eliminates the need for an external driver or ballast
- Up to 145 lumens per watt
- Three selectable wattage
- Complies with UL safety regulations and is DLC5.1 listed
- High Quality and Efficacy Lumiled 2835 chips
- This product is IP65 rated, therefore, it is waterproof, sealed and gasketed wire
- Universal operation at 120-277Vac 50-60Hz
- Environment friendly with no mercury
- Easy to install and operate, with instant & no humming
- Energy saving, long lifespan

LED WALL PACK



SKU #	Model #	Wattage Adjustable	Lumens Adj.	CCT	IP	Dimming	Input Voltage	Housing	Certifications
1530459	BLT-SWP05M-60HBSGSA1-BRW50A	40W/50W/60W	5260Lm/8866Lm	5000K	IP65	0-10V	100V-277V	Bronze	UL & DLC
1530462	BLT-SWP05M-120DBSGSA1-BRW50A	80W/100W/120W	11274Lm/17844Lm	5000K	IP65	0-10V	120V-277V	Bronze	UL & DLC
1550457	BLT-SWP01C-200W BPSA1-BRSW50	150W/180W/200W	19500Lm/26000Lm	5000K	IP65	0-10V	100V-277V	Bronze	UL & DLC

SKU #. 1530459 Specifications

Parameter	Description	Value
General Performance	Model #	BLT-SWP05M-60HBSGSA1-BRW50A
	Wattage Adjustable	40W / 50W / 60W
	Lumens Adjustable	5260Lm / 8866Lm
	Lumen Efficacy	Up to 145LM/W
	Color Temperature	5000K
	CRI (Ra)	>80
	Beam Angle (50%)	100° Degree
	Diffuser	PC Lens
Electrical	Tolerance	±15%
	Input Voltage	120-277Vac
	Frequency	50/60Hz
	PF	≥0.9
	THD	≤20%
	Driver Model	HB-LPG060-52
Physical	Driver Surge protection	L-N: 2kV
	Dimming	0-10V Dimming Standard
	Operating Temperature	-40°C TO 50°C
	Storage Temperature	-40°C TO 80°C
	Operating Humidity	20% - 90% RH
	Storage Humidity	10% - 95% RH
	LED Brand	LUMILEDS
	LED Type	SMD 2835
LED Qty	225 Pcs	
Qualification	Housing	Die-Cast Aluminum
	Housing Color	Bronze
	Waterproof Rating	WET (IP65)

LED WALL PACK

SKU #. 1530462

Specifications

Parameter	Description	Value
General Performance	Model #	BLT-SWP05M-120DBSGSA1-BRW50A
	Wattage Adjustable	80W / 100W / 120W
	Lumens Adjustable	11274Lm / 17844Lm
	Lumen Efficacy	Up to 145LM/W
	Color Temperature	5000K
	CRI (Ra)	>80
	Beam Angle (50%)	100° Degree
	Diffuser	PC Lens
Electrical	Tolerance	±15%
	Input Voltage	120-277Vac
	Frequency	50/60Hz
	PF	≥0.9
	THD	≤20%
	Driver Model	MP-120TG130A
Physical	Driver Surge protection	L-N: 2kV
	Dimming	0-10V Dimming Standard
	Operating Temperature	-40°C TO 50°C
	Storage Temperature	-40°C TO 80°C
	Operating Humidity	20% - 90% RH
	Storage Humidity	10% - 95% RH
	LED Brand	LUMILEDS
	LED Type	SMD 2835
	LED Qty	420 Pcs
Qualification	Housing	Die-Cast Aluminum
	Housing Color	Bronze
	Waterproof Rating	WET (IP65)
	Warranty	5 Years

LED WALL PACK



SKU #. 1550457

Specifications

Parameter	Description	Value
General Performance	Model #	BLT-SWP01C-200WBSPSA1-BRSW50
	Wattage Adjustable	150W / 180W / 200W
	Lumens Adjustable	19500Lm / 26000Lm
	Lumen Efficacy	Up to 145LM/W
	Color Temperature	5000K
	CRI (Ra)	B4-U4-G5
	BUG	>80
	Beam Angle (50%)	H95*V101 Degree
	Diffuser	PC Lens
Electrical	Tolerance	±15%
	Input Voltage	120-277Vac
	Frequency	50/60Hz
	PF	≥0.9
	THD	≤20%
	Flicker Percent	<50%
	Driver Model	WP-CNB-200U-2A0SCPO7-Z-PRO
Physical	Driver Surge protection	L/N-PE: 6kV, L-N: 4kV
	Dimming	0-10V Dimming Standard
	Operating Temperature	Without Motion Sensor: -40°C TO 50°C; With Motion Sensor: -25°C TO 50°C
	Storage Temperature	-40°C TO 80°C
	Operating Humidity	20% - 90% RH
	Storage Humidity	10% - 95% RH
	LED Brand	LUMILEDS
	LED Type	SMD 2835
	LED Qty	390 Pcs
Qualification	Housing	Die-Cast Aluminum
	Housing Color	Bronze
	Waterproof Rating	WET (IP65)
	Warranty	5 Years

LED WALL PACK

Correlated Color Temperature (CCT)

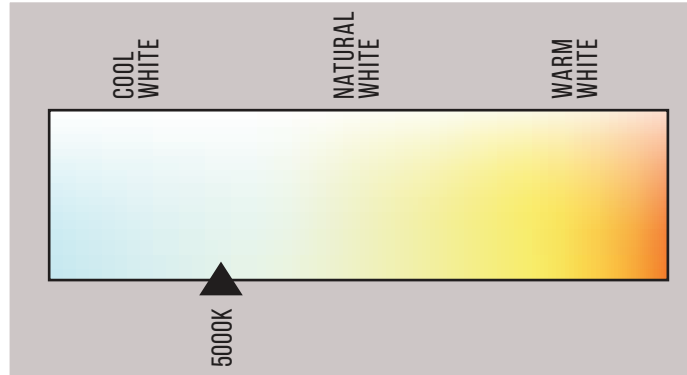

Dimensions (SKU: 153459 - 153462)

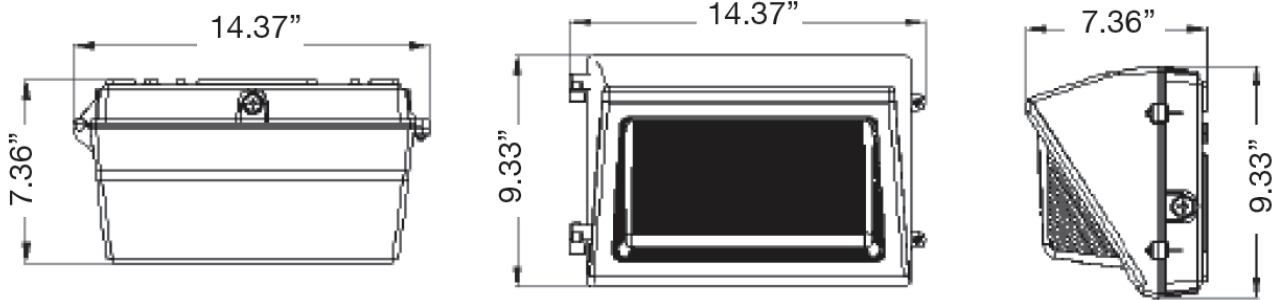

Dimensions (SKU: 155457)

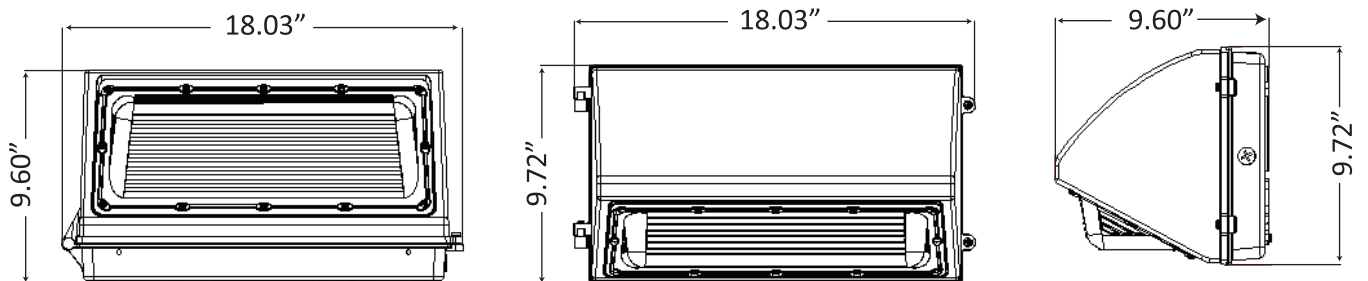

LED WALL PACK



Light Distribution Testing Parameters (SKU #.1530459)

Luminaire Data

Voltage: 119.9 V
 Current: 0.486 A
 Power: 58.12 W
 Power Factor: 0.996

Photometric Results

IES Classification: Type IV
 Total Rated Lamp Lumens: 8458.2 lm
 Efficiency: 100%
 Upward Ratio: 12%
 C0r0 Intensity: 1918.19 cd
 Pos of Max. Intensity: H90 V55

Longitudinal Classification: Very Short
 Measurement Flux: 8458.2 lm
 Downward Ratio: 88%
 Luminaire Efficacy Rating (LER): 145.58
 Max. Intensity: 3506.85 cd

Luminous Intensity Distribution Curve

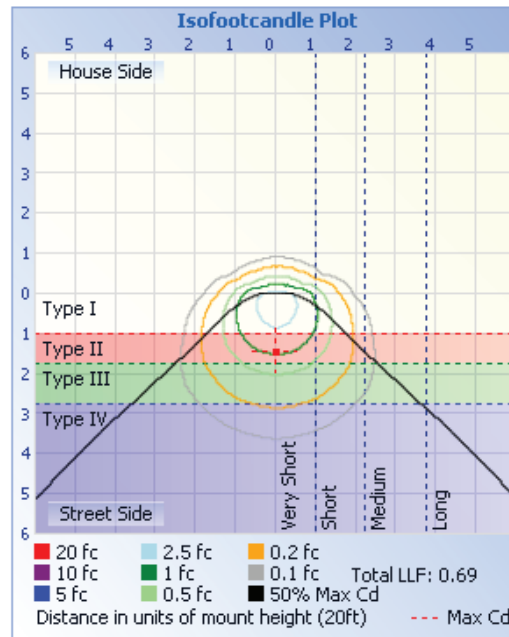
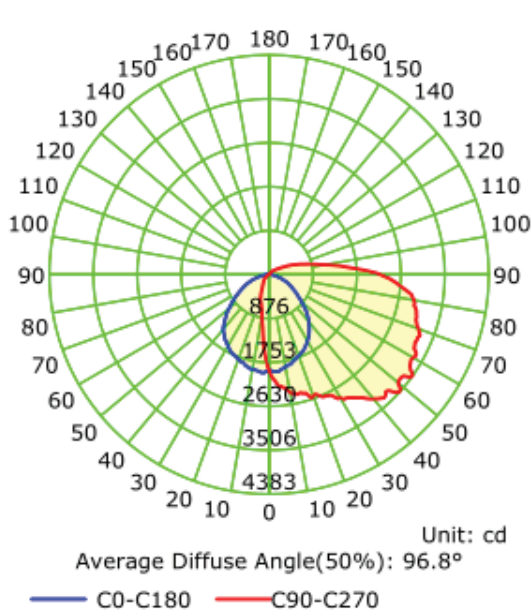

Light Distribution Testing Parameters (SKU #.1530462)

Luminaire Data

Voltage: 120.0 V
 Current: 1.03 A
 Power: 123.54 W
 Power Factor: 0.995

Photometric Results

IES Classification: Type IV
 Total Rated Lamp Lumens: 17446.0 lm
 Efficiency: 100%
 Upward Ratio: 13%
 C0r0 Intensity: 2845.51 cd
 Pos of Max. Intensity: H90 V57

Longitudinal Classification: Very Short
 Measurement Flux: 17446 lm
 Downward Ratio: 87%
 Luminaire Efficacy Rating (LER): 141.27
 Max. Intensity: 7466.82 cd

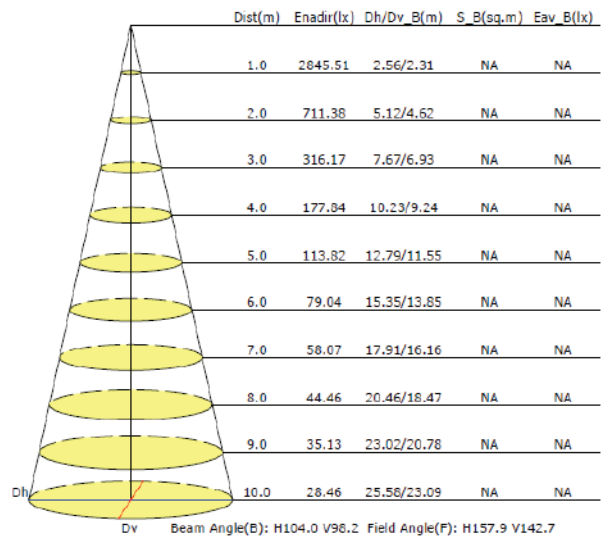
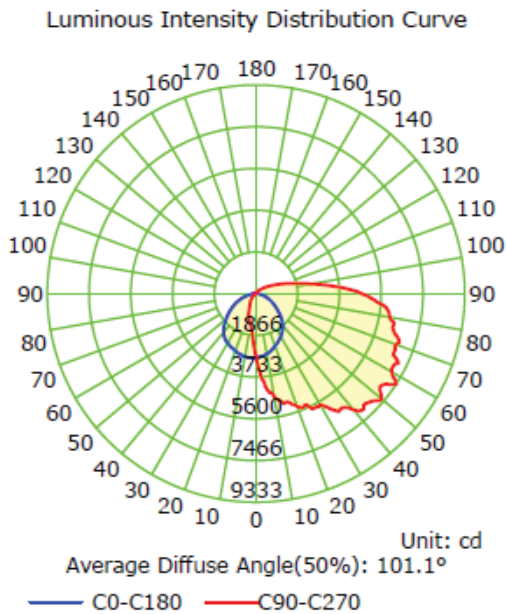

LED WALL PACK



Photometric Data (SKU:1550457)

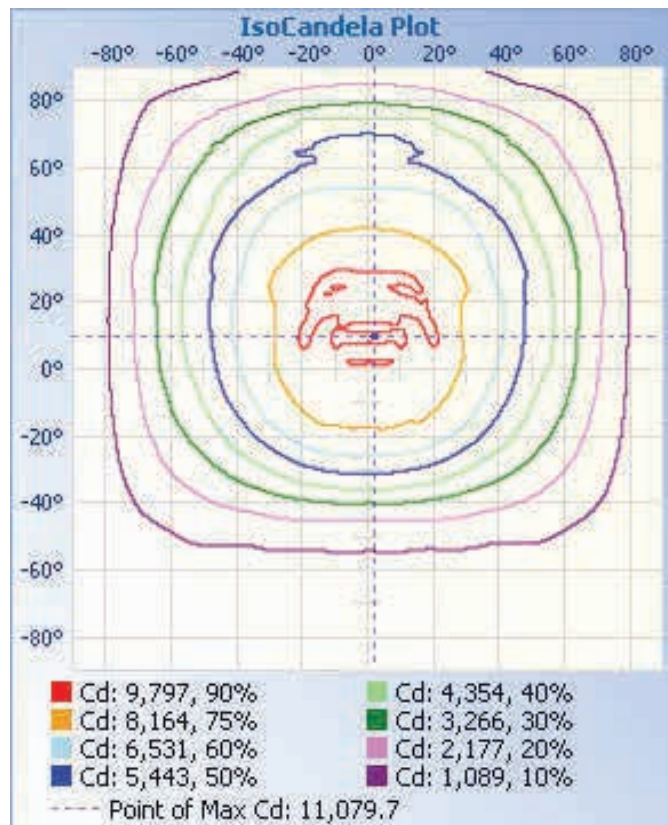
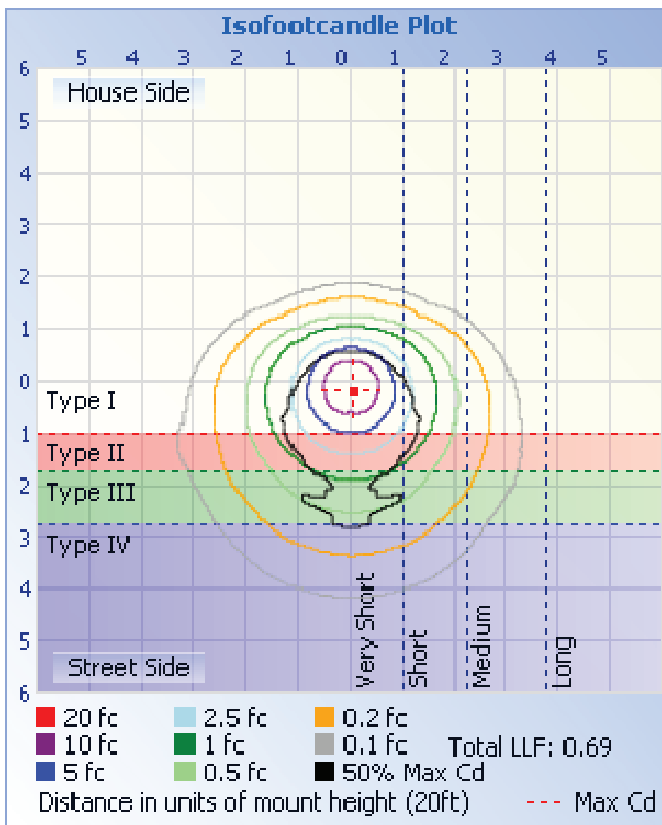
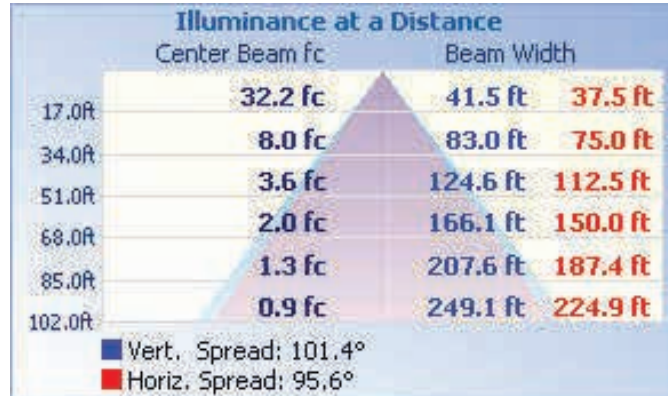
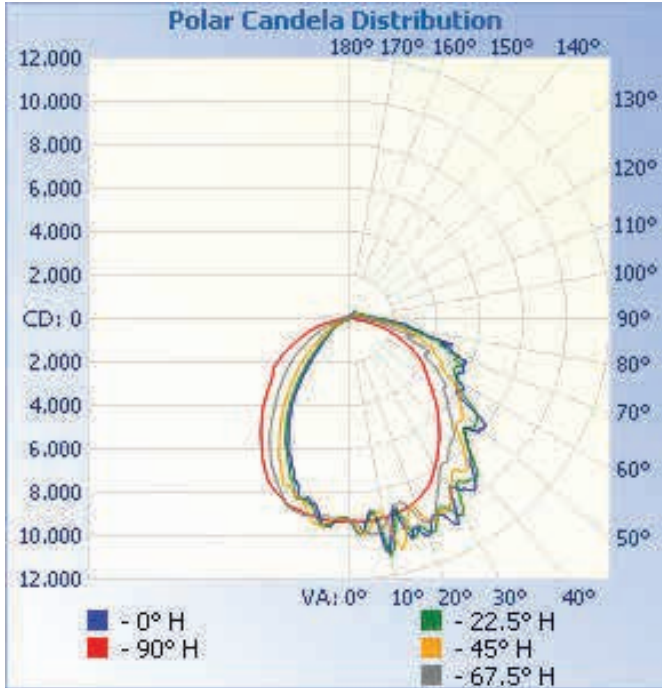

LED WALL PACK

Notes Before Installation

1. Be careful to open the carton, contact us if any damage.
2. This product must be installed in accordance with the applicable installation, code by a person familiar with the construction and operation of the product and the hazards involved.
3. “caution - risk of shock” and “disconnect power before servicing” when photoelectric switch provided.
4. Please check whether the voltage marked on the luminaire is consistent with the input voltage to be connected, so as not to damage the LED luminaire.
5. To ensure the lifetime of the product, please do not use it in a place with strong acid mist.
6. Make sure the installation position can withstand 10 times the weight of the luminaire before installation and install it at a flat place without vibration, no swing, no fire hazard.

Notes for Users

1. To avoid possibility of electrical shock or fire, the installation personnel must have professional electric knowledge;
 2. Please wear gloves to avoid injury before installation;
 3. If smoke or fire is found in wires or led fixture during or after installation, please turn off the power immediately and notify relevant personnel;
 4. This fixture is available in outdoor usage, but the distance from fixture to ground should be more than 2m.
- Please turn off power before install or change assembly parts.
 - The input voltage and lamps should be matched, after connecting the power line, Please make sure the wiring section is insulated.
 - No-professionals, must not install and disassemble the lamps.

Caution

1. This luminaire must be installed by qualified electrician to avoid electric shock and fire accident;
2. Wear gloves before installation in order to avoid injury;
3. Turn off the power immediately when there is smoke and fire during installation, inform professionals to overhaul;
4. This luminaire is suitable for outdoor use.

LED WALL PACK



Installation (SKU #.1530459 & 1530462)

Applications:

Tunnel (except for motor vehicle tunnel), workshop, warehouse, factory, house, building exterior, etc.

Cautions:

1. Do not use an electric generator to test the LED fixture. 2. Please abide by related country, regional and local law and regulations when install this fixture; 3. Do not install the fixture in raining days to avoid electrical shock or damage.

Notes:

1. To avoid possibility of electrical shock or fire, the installation personnel must have professional electric knowledge;
2. Please wear gloves to avoid injury before installation;
3. If smoke or fire is found in wires or led fixture during or after installation, please turn off the power immediately and notify relevant personnel;
4. This fixture is available in outdoor usage, but the distance from fixture to ground should be more than 2m.

This installation instruction applies to the following products. Although the products vary in appearance, their installation steps are the same:

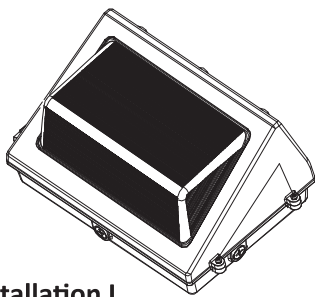

Installation I

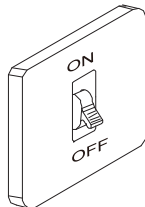

1. Turn of the power

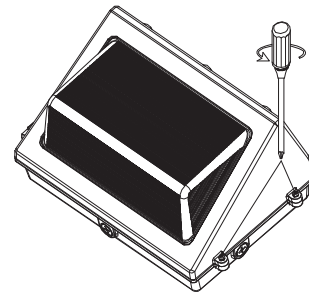

2. Use a screwdriver to remove the screws on both sides

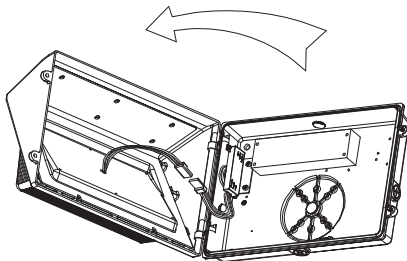

3. Open the fixture, disconnect the connection terminals. and remove the upper cover of the fixture.

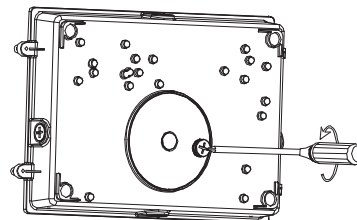

4. Use a screwdriver to remove the plug.

Installation

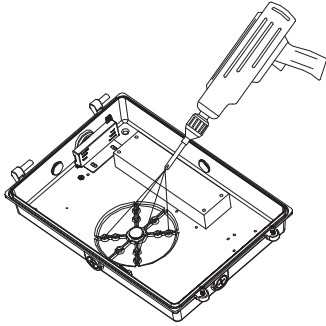

5. Drill through the mounting hole with an electric drill.

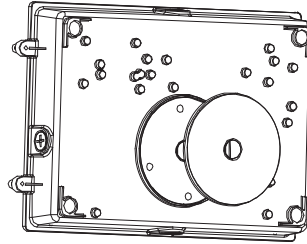

6. Attach EVS cotton pad to bottom shell

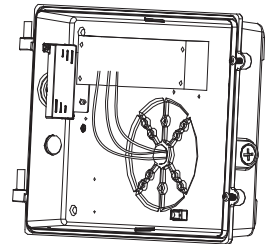

7. Thread the wire through the bottom hole.

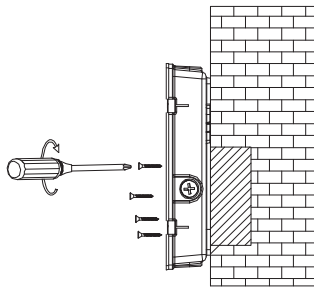

8. Lock the bottom shell on the mounting seat with screws.

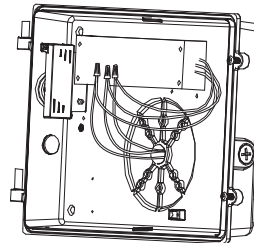

9. L, M & G wires connected to the power supply

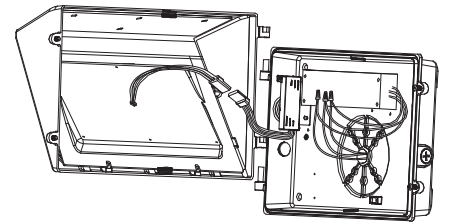

10. Install the cover of the fixture and connect the terminal block

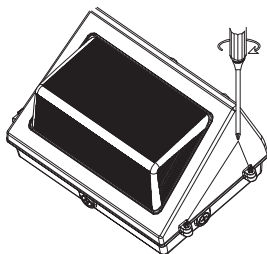

11. Fix the fixture with screws

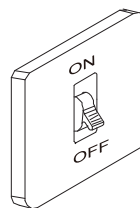

12. Make sure the installation is complete before turning on the power switch

Installation

Installation II

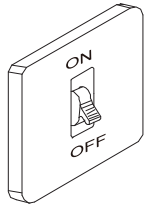

1. Turn off the power

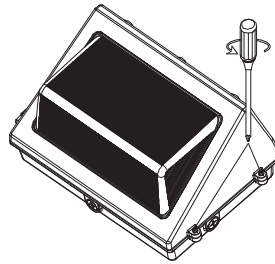

2. Use a screwdriver to remove the screws on both sides

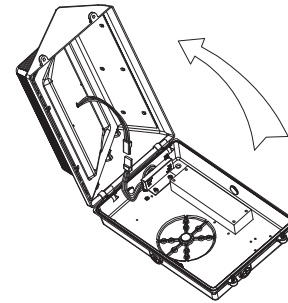

3. Open the fixture, disconnect the connection terminals and remove the upper cover of the fixture.

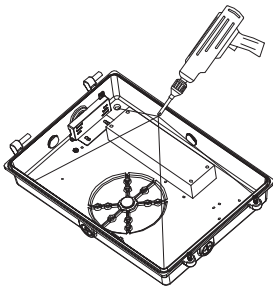

4. Drill through the mounting hole with an electric drill

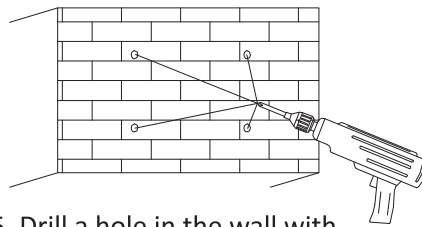

5. Drill a hole in the wall with an electric drill

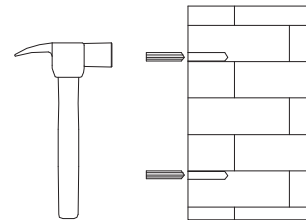

6. Push the expansion rubber plug into the mounting hole on the wall

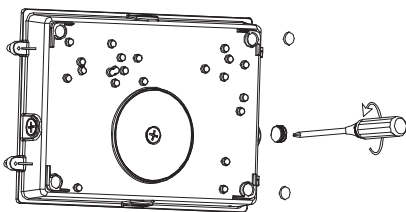

7. Use a screwdriver to remove the side plug and attach the EVA cotton pad to the mounting hole.

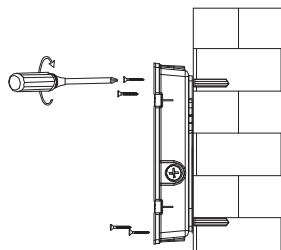

8. Push the expansion rubber plug into the mounting hole on the wall

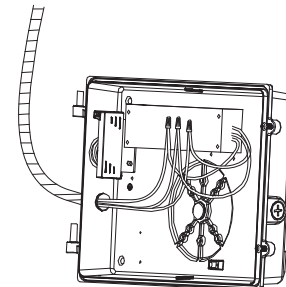

9. The top terminal connect the wire tube through the side hole to the L, N & G wires on the power supply.

Installation

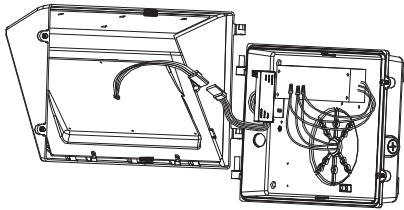

10. Install the upper cover of the fixture and connect the terminal line.

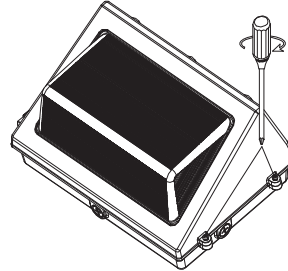

11. Fix the fixture with screws.

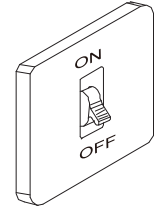

12. Make sure the installation is complete before turning on the power switch.

Standard wire:

L/live wire: Black\Brown; N/null wire: White\Blue; Ground wire: Green\Yellow-green. Warning: During grounding, make sure the earth wire of the driver and fixture housing are connect-ed together with the earth wire of the local power supply.

MIN 90°C SUPPLY CONDUCTORS THIS PRODUCT MUST BE INSTALLED IN ACCORDANCE WITH THE APPLICABLE INSTALLA-TION CODE BY A PERSON FAMILIAR WITH THE CONSTRUCTION AND OPERATION OF THE PRODUCT AND THE HAZARDS INVOLVED

Wiring and Features

Ulive wire: Black\Brown; N/null wire: White\Blue; Ground wire: Green\Yellow-green. Warning: During grounding, make sure the earth wire of the driver and fixture housing are connect-ed together with the earth wire of the local power supply.

MIN 90°C SUPPLY CONDUCTORS THIS PRODUCT MUST BE INSTALLED IN ACCORDANCE WITH THE APPLICABLE INSTALLA-TION CODE BY A PERSON FAMILIAR WITH THE CONSTRUCTION AND OPERATION OF THE PRODUCT AND THE HAZARDS INVOLVED

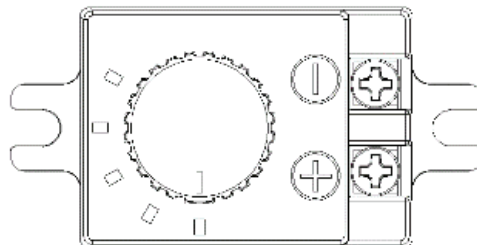

LED WALL PACK



Wattage adjustable instruction

Turn the wattage adjustable knob to a certain wattage gear, the power of the lamp will change to the corresponding wattage.

Note: Please turn off the power before adjusting the wattage.

Troubleshooting

Troubles	Check points
Flickering of the light	Turn off the power and turn on again in 3 minutes. If same phenomena occur, then call agencies.
Out of working	Please check the connection.

Installation (SKU #.1550457)

Application:

Available in tunnel (except for motor vehicle tunnel), workshop, warehouse, factory, house, building exterior, etc.

Caution:

1. Can not use the electric generator to test the LED lamp;
2. Please abide by related country, regional and local law and regulations when install this fixture;
3. Please don't install the fixture when raining to lower the risk of electric shock and avoid the failure.

Note:

1. To avoid possibility of electrical shock or fire, the installation personnel must have professional electric knowledge;
2. Please wear gloves to avoid injury before installation;
3. If any smoke or spark of the wire happened, please turn off the power immediately and notify relevant personnel;
4. This fixture is available in outdoor usage, but the distance from fixture to ground should be more than 2m.

This installation instruction applies to the following products. Although the products vary in appearance, their installation steps are the same:

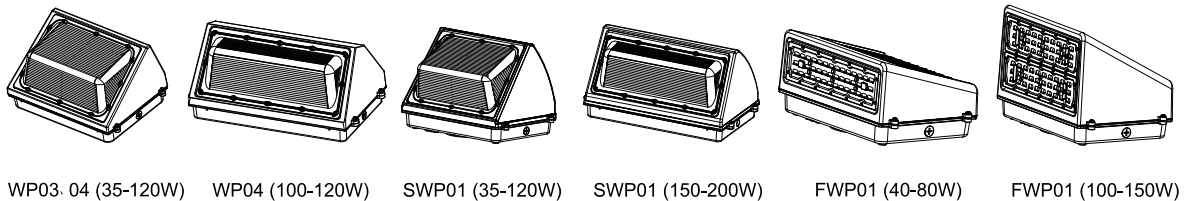

The installation of the product can be used when it is marked with "√".

Installation I:

1. Take out the light, and loosen the screws on the cover and take apart the fixture by the screwdriver. Pull off the quick connect terminal vigorously. (Figure1,A&B)

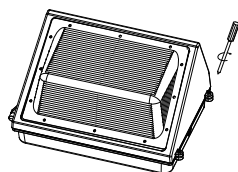

Figure 1, A

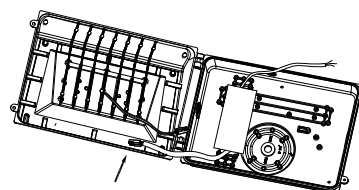

Figure 1, B

LED WALL PACK

Installation (SKU #.1550457)

2. Drill an installation holes at the bottle of light, paste the EVA mat. (Figure 2, A&B)

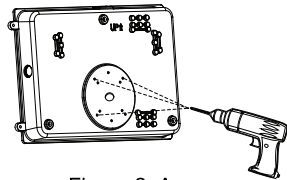

Figure 2, A

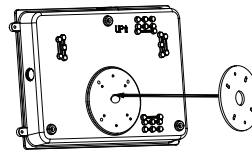

Figure 2, B

3. Loosen the plug on the bottom plate, then put the wiring through the hole, screw the bottom cover with junction box on the wall.(Figure 3, A&B) 4. Make wiring connections per "Electrical Connections" section and make sure the good wire protection.(Figure 4)

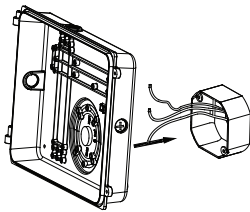

Figure 3, A

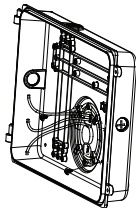

Figure 3, B

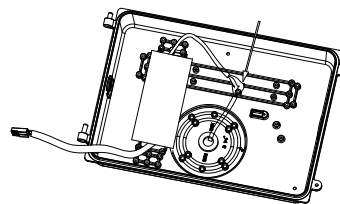

Figure 4

5. Connect the quick connect terminal, then screw the fixture with bottom plate. (Figure 5, A&B)

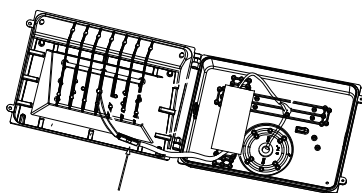

Figure 5, A

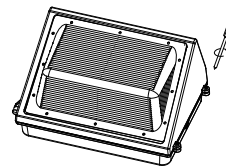

Figure 5, B

6. Please subject to the installation steps according to the actual products purchased. Follow the below additional installation steps if the product is equipped with areflector (Take the SWP01 series for example). When metal reflector is equipped, pls lock it on the luminaire with screws.(Figure 6)

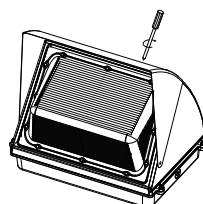

Figure 6

Installation (SKU #.1550457)

Installation II:

1. Take out the light, and loosen the screws on the cover and take apart the fixture by the screwdriver. Pull off the quick connect terminal vigorously. (Figure 1, A&B) 2. Choose an appropriate connection hole according to your requirements. Loosen the plug, and then tie the waterproof connector from the accessories; rotate the three mounting kits to the proper angle. (Figure 2)

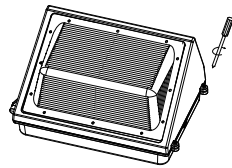

Figure 1, A

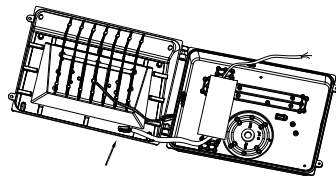

Figure 1, B

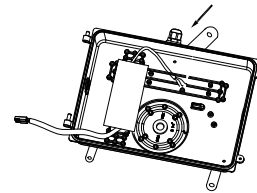

Figure 2

3. Put the fixture on the wall, make three marks according to the three mounting kits, then drill three holes for them. (Figure 3, A) Get rubber plugs into the holes, match the three mounting kits to the rubber plugs, then fix the fixture on the wall by screws with the spring washer and plain cushion. (Figure 3, B&C)

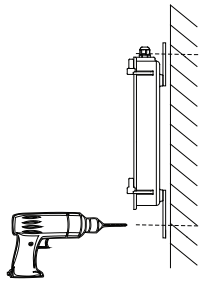

Figure 3, A

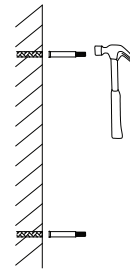

Figure 3, B

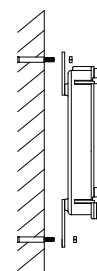

Figure 3, C

4. After installing the bottom plate, pull the outside wiring into the fixture by the waterproof connector, and tighten the screws on the connector. Make wiring connections per "Electrical Connections" section and make sure the good wire protection. (Figure 4)

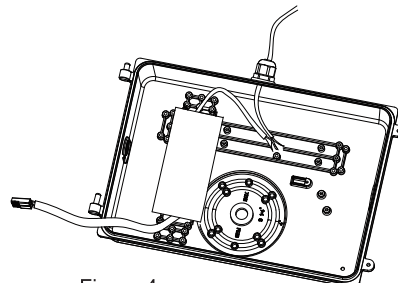

Figure 4

Installation (SKU #.1550457)

5. Connect the quick connect terminal, then screw the fixture bottom plate (Figure 5, A&B)

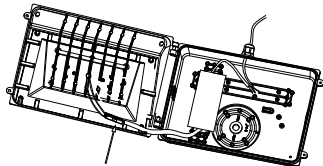

Figure 5, A

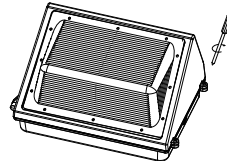

Figure 5, B

6. Please subject to the installation steps according to the actual products purchased. Follow the below additional installation steps if the product is equipped with areflector (Take the SWP01 series for example). When metal reflector is equipped, pls lock it on the luminaire with screws.(Figure 6)

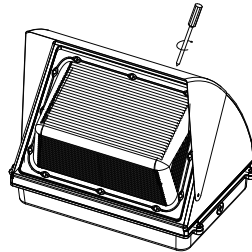

Figure 6

Standard wire:

L/live wire: Black\Brown;

N/null wire: White\Blue;

Ground wire: Green\Yellow-green.

Warning: During grounding, make sure the earth wire of the drive and lam housing are connected together with the earth wire of the local power supply.

Warn i ng/Advertisement:

MIN 75 °C SUPPLY CONDUCTOR THIS PRODUCT MUST BE INSTALLED IN ACCORDANCE WITH THE APPLICABLE INSTALLATION CODE BY A PERSON FAMILIAR WITH THE CONSTRUCTION AND OPERATION OF THE PRODUCT AND THE HAZARDS INVOLVED. LES FILS D'ALIMENTATION 75 °C MIN CE PRODUIT DOIT ETRE INSTALLE SELON LE CODE D'INSTALLATION PERTINENT, PAR UNE PERSONNE QUI CONNAIT BIEN LE PRODUIT ET SON FONCTIONNEMENT AINSI QUE LES RISQUES INHERENTS.

LED WALL PACK

Packaging

SKU #	Box	Size (Inches)	Qty/Carton	Net Weight/ Carton	Gross Weight/ Carton
1530459	Outer Box	16 x 12 x 10	1Pc	7.93 Lbs.	10.14 Lbs.
1530462	Outer Box	16 x 12 x 10	1Pc	7.93 Lbs.	10.14 Lbs.
1550457	Outer Box	19.68 x 12 x 12.40	1Pc	13.05 Lbs.	16.09 Lbs.

**Tolerance of Carton Size: ±15 MM, Tolerance of Weight: ±10%.

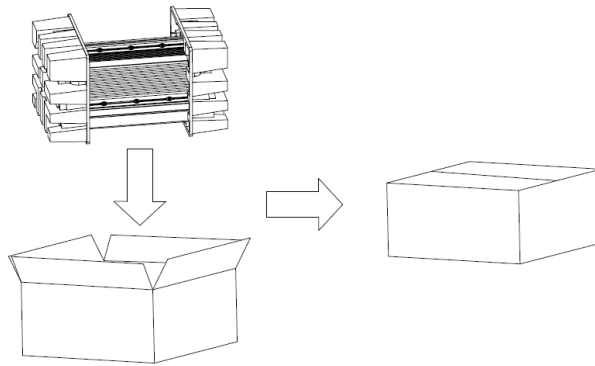

1. Please do not shake it too much during transportation, handle carefully when unloading.
2. Recommended to be stored in a warehouse of -10~ +60 °C and keep the warehouse dry

LED WALL PACK



Application Picture



LED WALL PACK

Application Picture

To reduce the risk of death, personal injury or property damage from fire, electric shock, falling parts, cuts/abrasions, and other hazards read all warnings and instructions included with and on the fixture box and all fixture labels.

Before installing, servicing, or performing routine maintenance upon this equipment, follow these general precautions.

Commercial installation, service and maintenance of luminaires should be performed by a qualified licensed electrician.

For the installation: If you are unsure about the installation or maintenance of the luminaires, consult a qualified licensed electrician and check your local electrical code.

To prevent wiring damage or abrasion, do not expose wiring to edges of sheet metal or other sharp objects.

Do not make or alter any open holes in an enclosure of wiring or electrical components during kit installation.

WARNING: RISK OF FIRE OR ELECTRICAL SHOCK

Turn off electrical power at fuse or circuit breaker box before wiring fixture to the power supply. Turn off the power when you perform any maintenance.

Verify that supply voltage is correct by comparing it with the luminaire label information. Make all electrical and grounded connections in accordance with the National Electrical Code and any applicable local code requirements. All wiring connections should be capped with UL approved wire connectors.

CAUTION: RISK OF INJURY

Avoid direct eye exposure to the light source while it is on.

Account for small parts and destroy packing material, as these may be hazardous to children.

Warranty

5 Years Warranty