

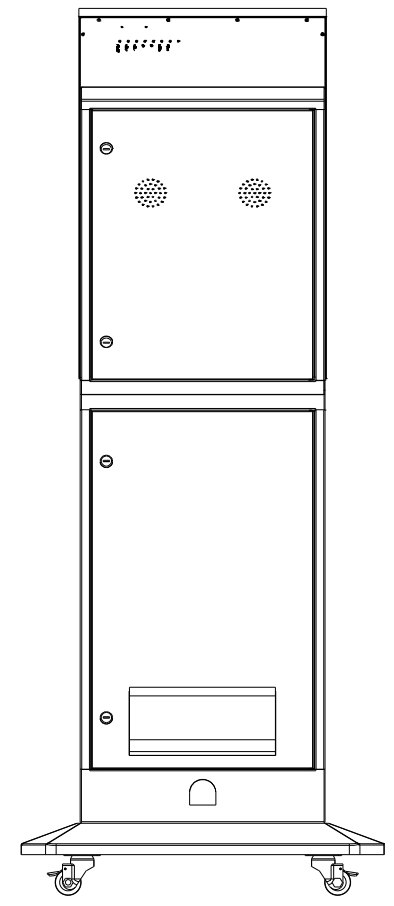

1 2 3 4 5 6 7 8

No.	Rev.	Revision Record	Date
△			

A  
B  
C  
D  
E  
F

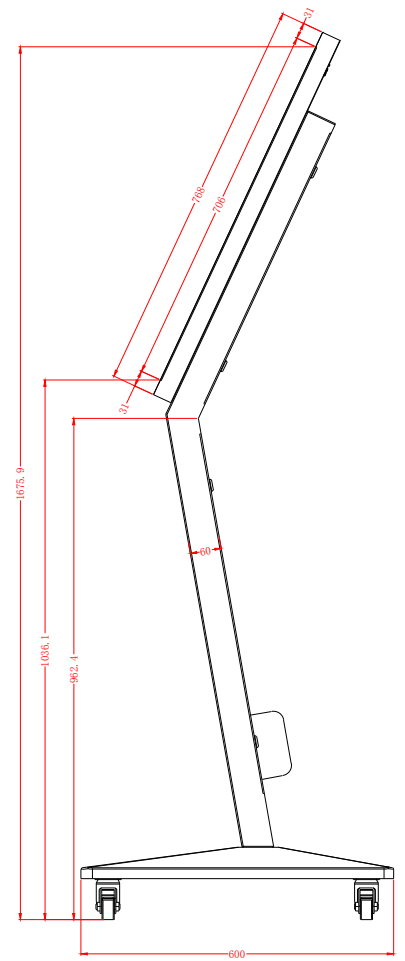
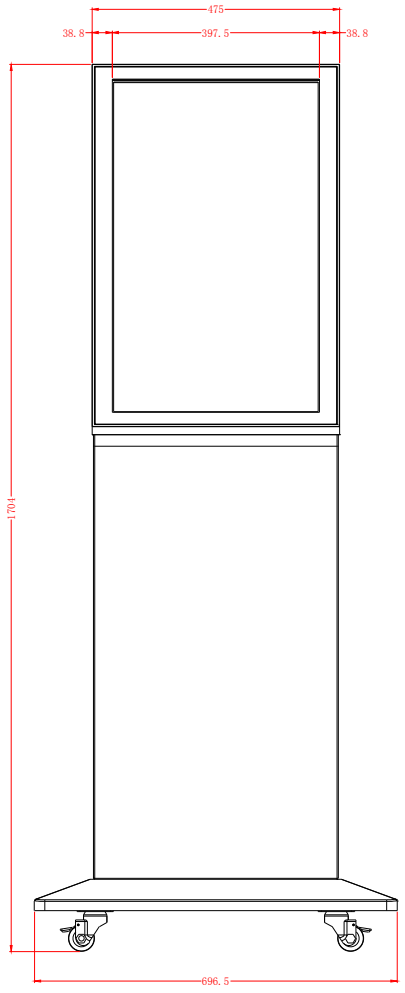

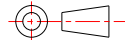

General Tolerance ISO 2768-lc	ISO 2768-lc	 深圳市飞帆泰科技有限公司 SHENZHEN FEIFANTAI TECHNOLOGY CO., LTD			
UNIT	mm	Description		32寸竖放	
Scale	1:1	Designed	jiangfan	Date	2018-11-05
REV.	A0	Checked		Date	
		Approved		Date	

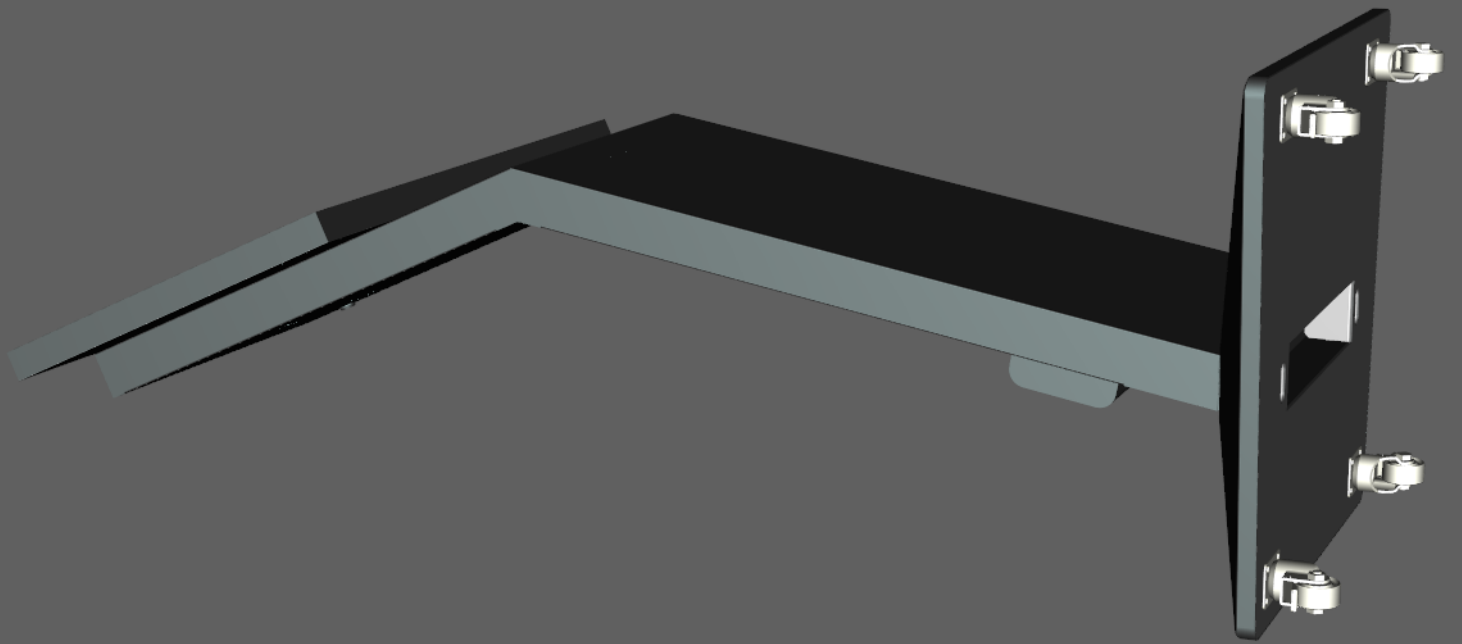
1 2 3 4 5 6 7 8

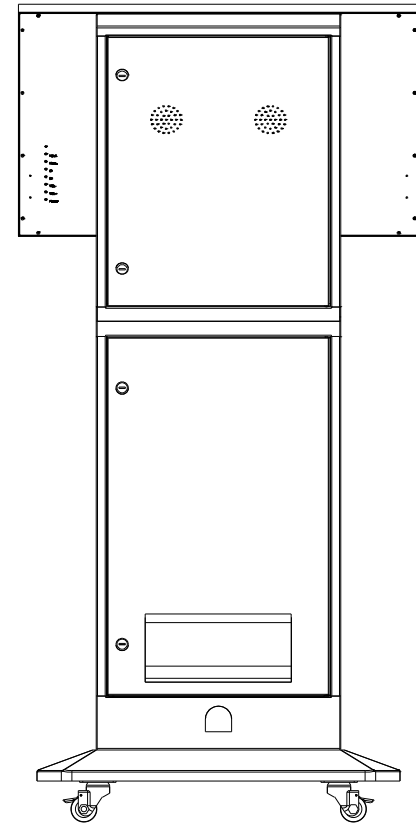
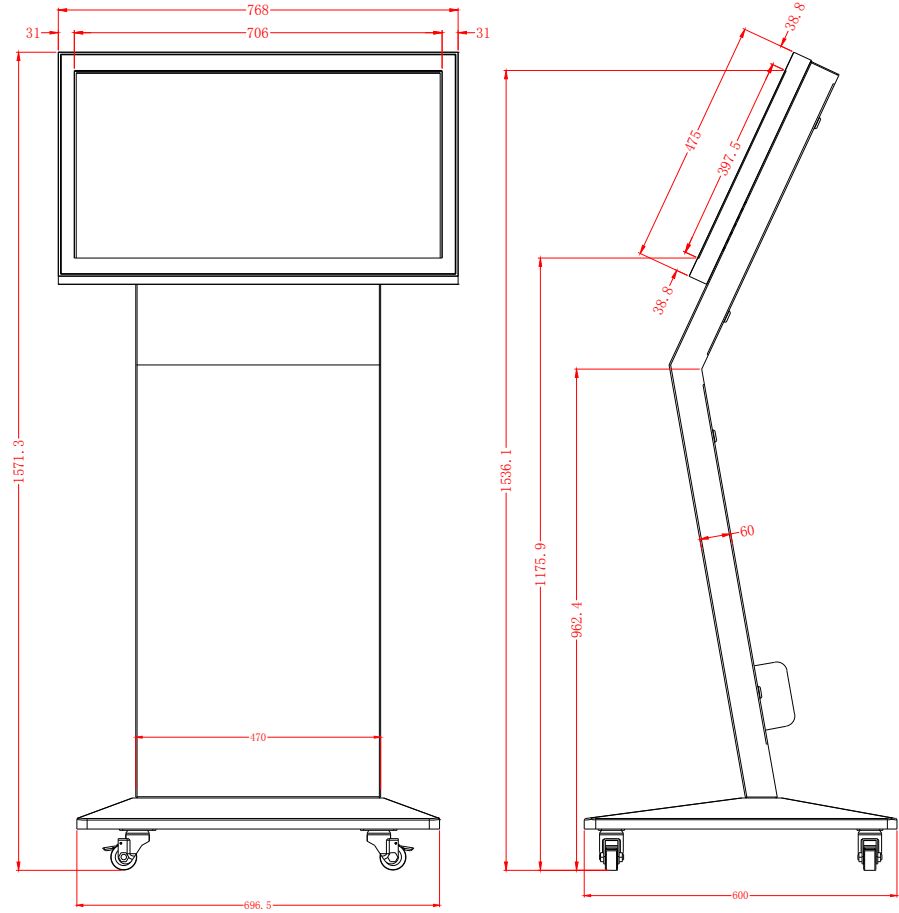

6		7			8
No.	Rev.	Revision Record		Date	
△					

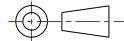

General Tolerance ISO 2768-1c	ISO 2768-1c	 深圳市飞帆泰科技有限公司 SHENZHEN FEIFANTAI TECHNOLOGY CO., LTD			
UNIT	mm	Description		32寸横放	
Scale	1:1	Designed	jiangfan	Date	2018-11-05
REV.	A0	Checked		Date	
		Approved		Date	

1 2 3 4 5 6 7 8

No.	Rev.	Revision Record	Date
△			

A

A

B

B

C

C

D

D

E

E

F

F

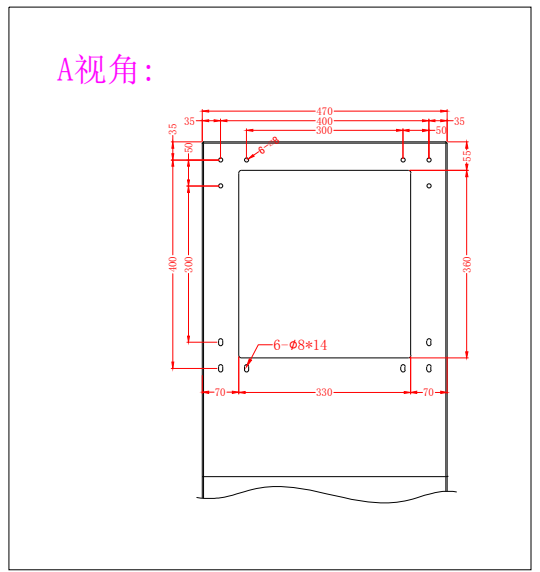
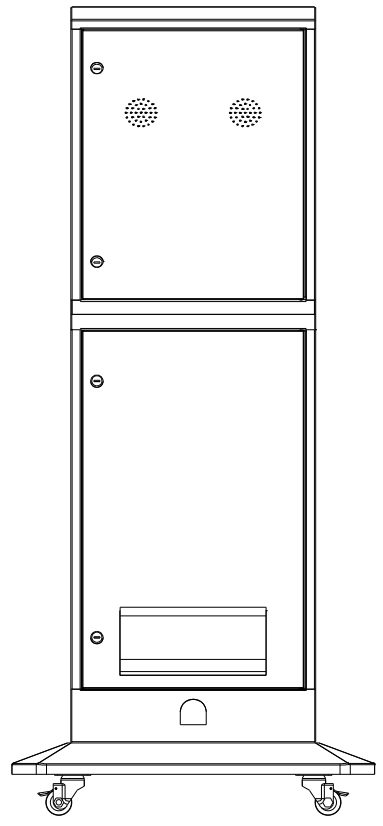
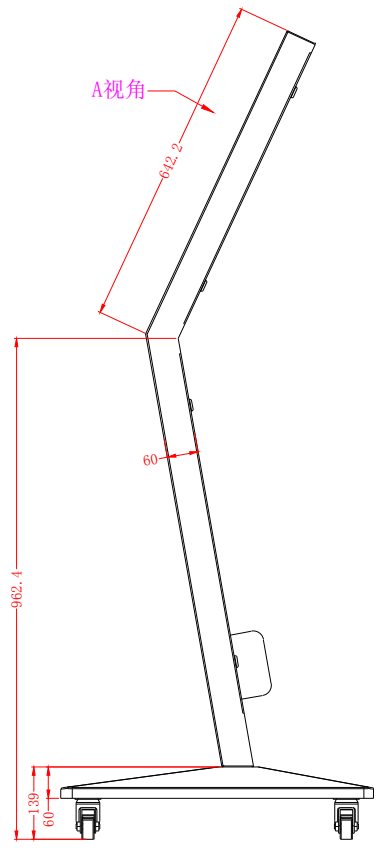
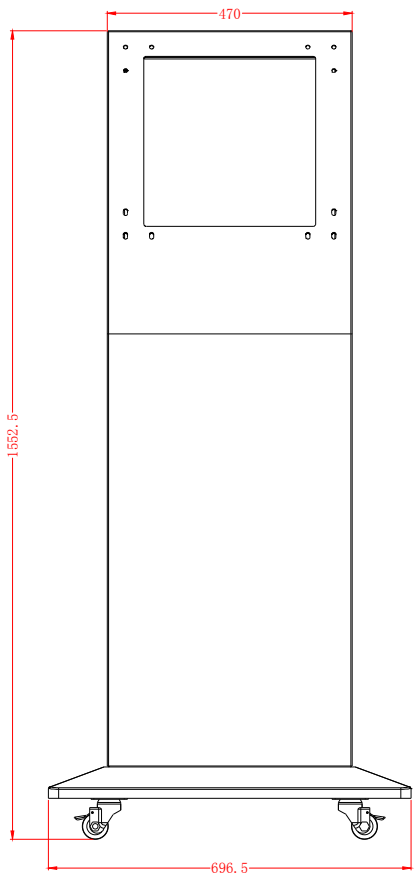

General Tolerance ISO 2768-1c	ISO 2768-1c	深圳市飞帆泰科技有限公司 SHENZHEN FEIFANTAI TECHNOLOGY CO., LTD			
UNIT	mm	Description		标准支架	
Scale	1:1	Designed	jiangfan	Date	2018-11-05
REV.	A0	Checked		Date	
		Approved		Date	

1 2 3 4 5 6 7 8