

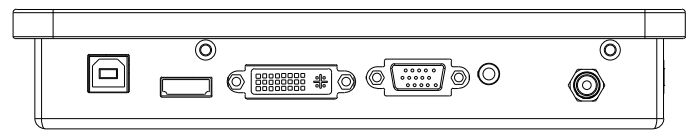

6		7			8
No.	Rev.	Revision Record		Date	
△					

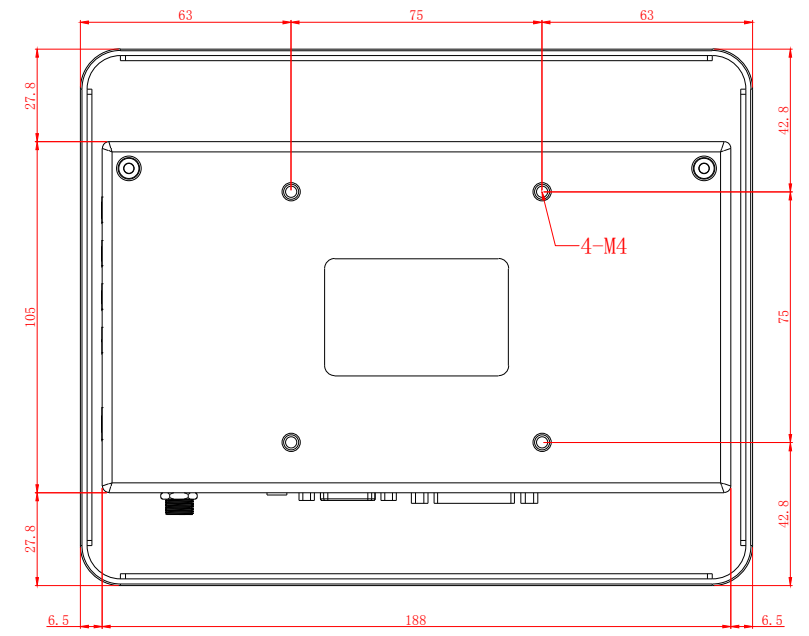
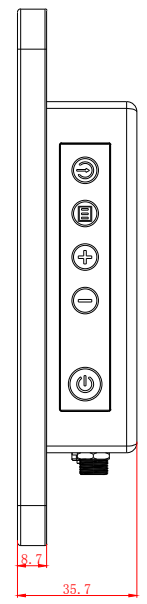
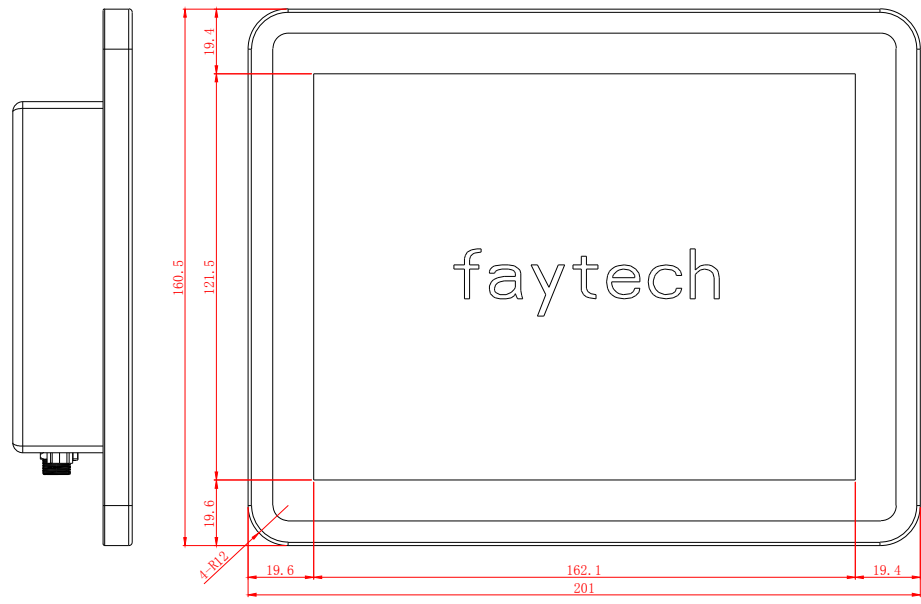
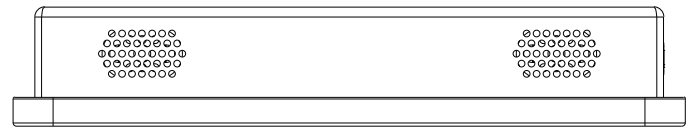
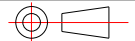

Tolerance: ±0.5MM

General Tolerance	ISO 2768-lc	 深圳市飞帆泰科技有限公司 SHENZHEN FEIFANTAI TECHNOLOGY CO., LTD			
UNIT	mm	Description		20205005889-8寸电容触摸显示器	
Scale	1:1	Designed	Noah	Date	2020-08-12
REV.	A0	Checked		Date	
		Approved		Date	