



VPC-5620S

Industrial & Mobile NVR

User's Manual 4th Ed

Copyright Notice

This document is copyrighted, 2022. All rights are reserved. The original manufacturer reserves the right to make improvements to the products described in this manual at any time without notice.

No part of this manual may be reproduced, copied, translated, or transmitted in any form or by any means without the prior written permission of the original manufacturer. Information provided in this manual is intended to be accurate and reliable. However, the original manufacturer assumes no responsibility for its use, or for any infringements upon the rights of third parties that may result from its use.

The material in this document is for product information only and is subject to change without notice. While reasonable efforts have been made in the preparation of this document to assure its accuracy, AAEMON assumes no liabilities resulting from errors or omissions in this document, or from the use of the information contained herein.

AAEMON reserves the right to make changes in the product design without notice to its users.

Acknowledgements

All other products' name or trademarks are properties of their respective owners.

- Microsoft Windows is a registered trademark of Microsoft Corp.
- Intel® and Celeron® are registered trademarks of Intel Corporation
- Intel Core™ is a trademark of Intel Corporation
- ITE is a trademark of Integrated Technology Express, Inc.
- IBM, PC/AT, PS/2, and VGA are trademarks of International Business Machines Corporation.

All other product names or trademarks are properties of their respective owners.

Packing List

Before setting up your product, please make sure the following items have been shipped:

Item	Quantity
● VPC-5620S	1
● SATA Cable	2
● Power Cable for SATA	2
● DIMM Thermal Pad	1
● Mating Connector for Power Input	1

If any of these items are missing or damaged, please contact your distributor or sales representative immediately.

About this Document

This User's Manual contains all the essential information, such as detailed descriptions and explanations on the product's hardware and software features (if any), its specifications, dimensions, jumper/connector settings/definitions, and driver installation instructions (if any), to facilitate users in setting up their product.

Users may refer to the product page at AAEON.com for the latest version of this document.

Safety Precautions

Please read the following safety instructions carefully. It is advised that you keep this manual for future reference.

1. All cautions and warnings on the device should be noted.
2. All cables and adapters supplied by AAEON are certified and in accordance with the material safety laws and regulations of the country of sale. Do not use any cables or adapters not supplied by AAEON to prevent system malfunction or fires.
3. Make sure the power source matches the power rating of the device.
4. Position the power cord so that people cannot step on it. Do not place anything over the power cord.
5. Always completely disconnect the power before working on the system's hardware.
6. No connections should be made when the system is powered as a sudden rush of power may damage sensitive electronic components.
7. If the device is not to be used for a long time, disconnect it from the power supply to avoid damage by transient over-voltage.
8. Always disconnect this device from any AC supply before cleaning.
9. While cleaning, use a damp cloth instead of liquid or spray detergents.
10. Make sure the device is installed near a power outlet and is easily accessible.
11. Keep this device away from humidity.
12. Place the device on a solid surface during installation to prevent falls.
13. Do not cover the openings on the device to ensure optimal heat dissipation.
14. Watch out for high temperatures when the system is running.
15. Do not touch the heat sink or heat spreader when the system is running.
16. Never pour any liquid into the openings. This could cause fire or electric shock.

17. As most electronic components are sensitive to static electrical charge, be sure to ground yourself to prevent static charge when installing the internal components. Use a grounding wrist strap and contain all electronic components in any static-shielded containers.
18. If any of the following situations arises, please the contact our service personnel:
 - i. Damaged power cord or plug
 - ii. Liquid intrusion to the device
 - iii. Exposure to moisture
 - iv. Device is not working as expected or in a manner as described in this manual
 - v. The device is dropped or damaged
 - vi. Any obvious signs of damage displayed on the device
19. **DO NOT LEAVE THIS DEVICE IN AN UNCONTROLLED ENVIRONMENT WITH TEMPERATURES BEYOND THE DEVICE'S PERMITTED STORAGE TEMPERATURES (SEE CHAPTER 1) TO PREVENT DAMAGE.**

Warning!



This device complies with Part 15 FCC Rules. Operation is subject to the following two conditions: (1) this device may not cause harmful interference, and (2) this device must accept any interference received including interference that may cause undesired operation.

Caution:

There is a danger of explosion if the battery is incorrectly replaced. Replace only with the same or equivalent type recommended by the manufacturer. Dispose of used batteries according to the manufacturer's instructions and your local government's recycling or disposal directives.

Attention:

Il y a un risque d'explosion si la batterie est remplacée de façon incorrecte. Ne la remplacer qu'avec le même modèle ou équivalent recommandé par le constructeur. Recycler les batteries usées en accord avec les instructions du fabricant et les directives gouvernementales de recyclage.

产品中有毒有害物质或元素名称及含量

AAEON System

QO4-381 Rev.A0

部件名称	有毒有害物质或元素					
	铅 (Pb)	汞 (Hg)	镉 (Cd)	六价铬 (Cr(VI))	多溴联苯 (PBB)	多溴二苯醚 (PBDE)
印刷电路板 及其电子组件	×	○	○	○	○	○
外部信号 连接器及线材	×	○	○	○	○	○
外壳	○	○	○	○	○	○
中央处理器 与内存	×	○	○	○	○	○
硬盘	×	○	○	○	○	○
液晶模块	×	×	○	○	○	○
光驱	×	○	○	○	○	○
触控模块	×	○	○	○	○	○
电源	×	○	○	○	○	○
电池	×	○	○	○	○	○

本表格依据 SJ/T 11364 的规定编制。

○：表示该有毒有害物质在该部件所有均质材料中的含量均在 GB/T 26572 标准规定的限量要求以下。

×：表示该有害物质的某一均质材料超出了 GB/T 26572 的限量要求，然而该部件仍符合欧盟指令 2011/65/EU 的规范。

备注：

一、此产品所标示之环保使用期限，系指在一般正常使用状况下。

二、上述部件物质中央处理器、内存、硬盘、光驱、电源为选购品。

三、上述部件物质液晶模块、触控模块仅一体机产品适用。

China RoHS Requirement (EN)

Hazardous and Toxic Materials List

AAEON System

QO4-381 Rev.A0

Component Name	Hazardous or Toxic Materials or Elements					
	Lead (Pb)	Mercury (Hg)	Cadmium (Cd)	Hexavalent Chromium (Cr(VI))	Polybrominated biphenyls (PBBS)	Polybrominated ethers (PBDES)
PCB and Components	X	O	O	O	O	O
Wires & Connectors for Ext.Connections	X	O	O	O	O	O
Chassis	O	O	O	O	O	O
CPU & RAM	X	O	O	O	O	O
HDD Drive	X	O	O	O	O	O
LCD Module	X	X	O	O	O	O
Optical Drive	X	O	O	O	O	O
Touch Control Module	X	O	O	O	O	O
PSU	X	O	O	O	O	O
Battery	X	O	O	O	O	O

This form is prepared in compliance with the provisions of SJ/T 11364.

O: The level of toxic or hazardous materials present in this component and its parts is below the limit specified by GB/T 26572.

X: The level of toxic of hazardous materials present in the component exceed the limits specified by GB/T 26572, but is still in compliance with EU Directive 2011/65/EU (RoHS 2).

Notes:

1. The Environment Friendly Use Period indicated by labelling on this product is applicable only to use under normal conditions.
2. Individual components including the CPU, RAM/memory, HDD, optical drive, and PSU are optional.
3. LCD Module and Touch Control Module only applies to certain products which feature these components.

Table of Contents

Chapter 1 - Product Specifications	1
1.1 Specifications	2
Chapter 2 – Hardware Information	5
2.1 Dimensions	6
2.1.1 Industrial Chassis (VPC-5600S-IS)	6
2.1.2 Main Board.....	8
2.1.3 VPC-5620S with PER-T529 (COM Ports x 3) by Project	10
2.1.4 VPC-5620S with PER-T623 (USB Ports x 4) by Project	12
2.2 Jumpers and Connectors.....	14
2.3 List of Jumpers	16
2.3.1 Clear CMOS (CN10).....	16
2.3.2 Front Panel (CN12).....	16
2.3.3 DCIN Select Header (CN27)	17
2.4 List of Connectors.....	18
2.4.1 SATA Power Connector (CN8/CN11)	20
2.4.2 Front Panel Connector (CN12)	20
2.4.3 Expansion Board Connector (CN15)	21
2.4.4 Vehicle Power Board Expansion Connector (CN17).....	21
2.4.5 Vehicle Power Board Expansion Connector (CN18).....	22
2.4.6 RS-232 Serial Port 3/ 4 Connector (CN19/CN20)	22
2.4.7 Digital I/O Connector (CN21).....	23
2.4.8 DC Input (12~24V) (CN22).....	23
2.4.9 RS-232 Serial Port 1/ 2 Connector (CN24/CN25)	24
2.4.10 Software Reset Switch (SW2).....	24
2.5 Block Diagram.....	25
2.6 PER-T528 Power Expansion Board	26

2.6.1	PER-T528 Jumpers and Connectors.....	26
2.6.2	PER-T528 List of Connectors.....	26
2.6.2.1	Power Connector (CN1).....	27
2.6.2.2	MCU Programming Pin (CN5).....	27
2.6.2.3	Communication Pin Connector (CN9)	28
2.6.2.4	Communication Pin Header (CN10).....	28
2.7	PER-T529 In-Vehicle Expansion Board.....	29
2.7.1	PER-T529 Jumpers and Connectors.....	29
2.7.2	PER-T529 List of Jumpers.....	30
2.7.2.1	Reserved for Debug (CN6).....	30
2.7.2.2	Reserved for Debug (CN7).....	30
2.7.3	PER-T529 List of Connectors.....	31
2.7.3.1	CAN Bus Connector (CN4).....	31
2.7.3.2	Board to Board Connector (CN8).....	32
2.7.3.3	Power Connection (CN12).....	32
2.8	System Assembly (Industrial Chassis).....	33
2.8.1	2.5" SATA Drive and Bottom Panel Assembly	33
2.8.2	Wall Mount Assembly	34
2.9	System Assembly (Expanded Chassis).....	35
2.9.1	2.5" SATA Drive and Bottom Panel Assembly	35
2.9.2	RAM Installation	37
2.9.3	Wall Mount Assembly	39
Chapter 3 - AMI BIOS Setup.....		40
3.1	System Test and Initialization	41
3.2	AMI BIOS Setup	42
3.3	Setup Submenu: Main	43
3.4	Setup Submenu: Advanced.....	44
3.4.1	CPU Configuration	45

3.4.2	PCH-FW Configuration.....	46
3.4.2.1	Firmware Update Configuration.....	47
3.4.3	SATA and RST Configuration.....	48
3.4.4	NVMe Configuration.....	49
3.4.5	Hardware Monitor.....	50
3.4.6	SIO Configuration.....	51
3.4.6.1	Serial Port 1 Configuration.....	52
3.4.6.2	Serial Port 2 Configuration.....	53
3.4.6.3	Serial Port 3 Configuration.....	54
3.4.6.4	Serial Port 4 Configuration.....	55
3.4.6.5	Serial Port 5 Configuration.....	56
3.4.6.6	Serial Port 6 Configuration.....	57
3.4.6.7	Serial Port 7 Configuration.....	58
3.4.6.8	Serial Port 8 Configuration.....	59
3.4.6.9	Serial Port 9 Configuration.....	60
3.4.7	Power Management.....	61
3.4.8	Digital IO Port Configuration.....	63
3.4.9	Status LED Configuration.....	64
3.4.10	Network Stack Configuration.....	65
3.4.10.1	Network Stack Configuration (Enabled).....	66
3.5	Setup Submenu: Chipset.....	68
3.5.1	System Agent (SA) Configuration.....	69
3.5.2	PCH-IO Configuration.....	70
3.6	Setup Submenu: Security.....	71
3.6.1	Secure Boot.....	72
3.6.2	Key Management.....	74
3.7	Setup Submenu: Boot.....	78
3.8	Setup Submenu: Save & Exit.....	79

Chapter 4 – Drivers Installation	80
4.1 Driver Download and Installation.....	81
Chapter 5 – SDK Guide	83
5.1 Introduction	84
5.2 CAN Bus	85
5.2.1 CAN Bus Utility	85
5.2.2 CAN Bus SDK.....	89
5.3 Accelerometer & Gyroscope Utility	98
5.4 Power MCU Utility	100
5.5 Smart PoE Utility	101
5.5.1 About Smart PoE	101
5.5.2 Smart PoE Utility Description.....	102
5.6 DIO Utility.....	104
5.7 Watchdog SDK.....	105
Appendix A - I/O Information	106
A.1 I/O Address Map.....	107
A.2 IRQ Mapping Chart.....	109
A.3 Memory Address Map	121
Appendix B - Watchdog Timer Programming	123
B.1 Watchdog Timer Initial Program	124
Appendix C – Electrical Specifications for I/O Ports	129
C.1 Digital I/O Register.....	130
C.2 Digital I/O Sample Program.....	132

Chapter 1

Product Specifications

1.1 Specifications

System

Form Factor	Multi-PoE & Fanless Appliance
Processor	8 th Generation Intel® Core™ i7-8665UE Processor
Chipset	—
Main Memory	Up to 64GB, DDR4 260-pin SODIMM
Display	HDMI x 1 DP x 1
Ethernet	Gbps Ethernet x 1, Intel® i211 chipset; Wake-on-LAN and PXE supported
Smart PoE	4 ports IEEE 802.3 at/af, total 60W total power for every four ports. Supports independent power management of individual PoE ports via SDK package.
RAID support	0/1
Expansion Slot	VPC-5620S IS: mPCIe Full-Size x 1 (USB + PCIe) mPCIe Full-Size x 1 (USB + SATA) co-lay SATA M.2 2280 x 1 (USB + PCIe), supports NVMe PCIe [x4] SSD
Expansion Slot (Continued)	VPC-5620 VS: mPCIe Full-Size x 3 (USB + PCIe) mPCIe Full-Size x 1 (USB + SATA) co-lay SATA M.2 2280 x 1 (USB + PCIe), supports NVMe

System

	PCIe [x4] SSD
GPS, G-Sensor	VPC-5620 VS only: Built-in GPS, Gyro & G-Sensor
Front I/O Panel	RJ45 Smart PoE Port x 4 (60W total) USB3.2 Gen 1 x 4 Gbps LAN port x 1 DP x 1 Power Button x 1 Status LED x 1 HDD LED x 1 Wireless LED x 1 Micro SIM slots x 2 (VPC-5620 IS) Micro SIM slots x 4 (VPC-5620S VS) Antenna holes x 2 CANbus x 1 (VPC-5620S VS) RS-232 x 3 (VPC-5620S VS)
Rear I/O Panel	Audio Jack x 1 (Line Out & Mic In) HDMI port x 1 RS-232/422/485 x 2 (isolated by BOM option) Hardware Reset x 1 3-pin Power Input x 1
Rear I/O Panel (Continued)	8-bit DIO (Isolated 4DI & 4DO, 8DI, or 8DO per BOM option) Antenna holes x 2

Storage

HDD Tray	VPC-5620S IS: 2.5" HDD/SSD Bay x 2 VPC-5620S VS: 2.5" HDD/SSD Bay x 1
CF/CFast/mSATA Slot	—

Environmental

Operating Temperature	-4°F ~ 158°F (-20°C ~ 70°C)
Storage Temperature	-40°F ~ 185°F (-40°C ~ 85°C)
Storage Humidity	10%~80% at 40°C, non-condensing
Vibration/Shock	MIL-STD-810G
Certification	CE & FCC Class A

Power Requirements

Power Supply	VPC-5620S IS: DC 12~24V VPC-5620S VS: DC 9~36V with power ignition
--------------	---

Mechanical

Removable HDD Tray	—
Internal System HDD Bay	VPC-5620S IS: 2.5" HDD/SSD Bay x 2 VPC-5620S VS: 2.5" HDD/SSD Bay x 1
Dimensions	VPC-5620S IS: 6.3" x 5.87" x 2.16" (180mm x 149mm x 55mm)
Dimensions (Continued)	VPC-5620S VS: 6.3" x 5.87" x 2.95" (180mm x 149mm x 75mm)
Gross Weight	TBD
Note	—

Chapter 2

Hardware Information

2.1 Dimensions

2.1.1 Industrial Chassis (VPC-5600S-IS)

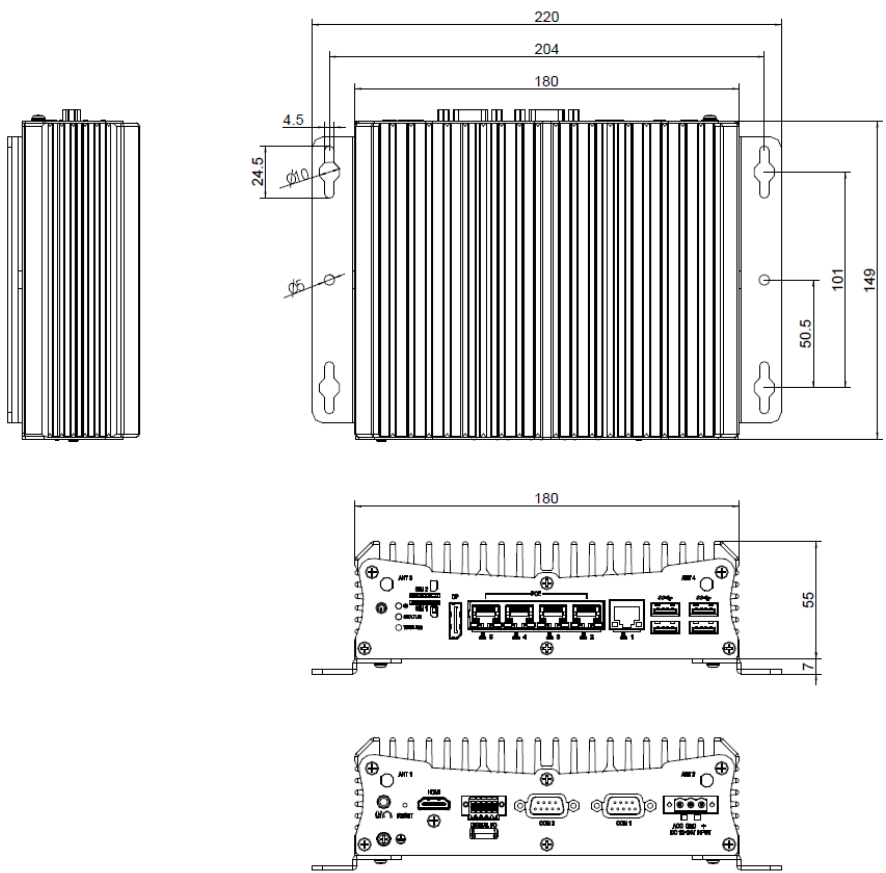

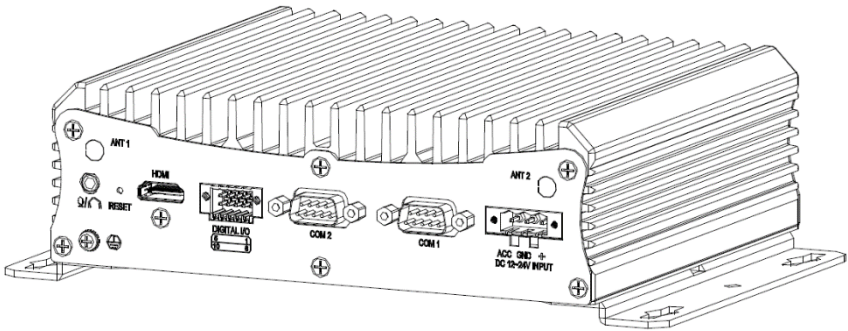
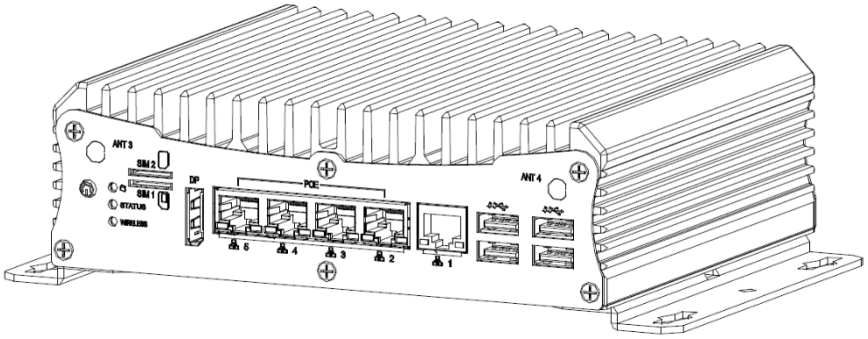

2.1.2 Main Board

Component side

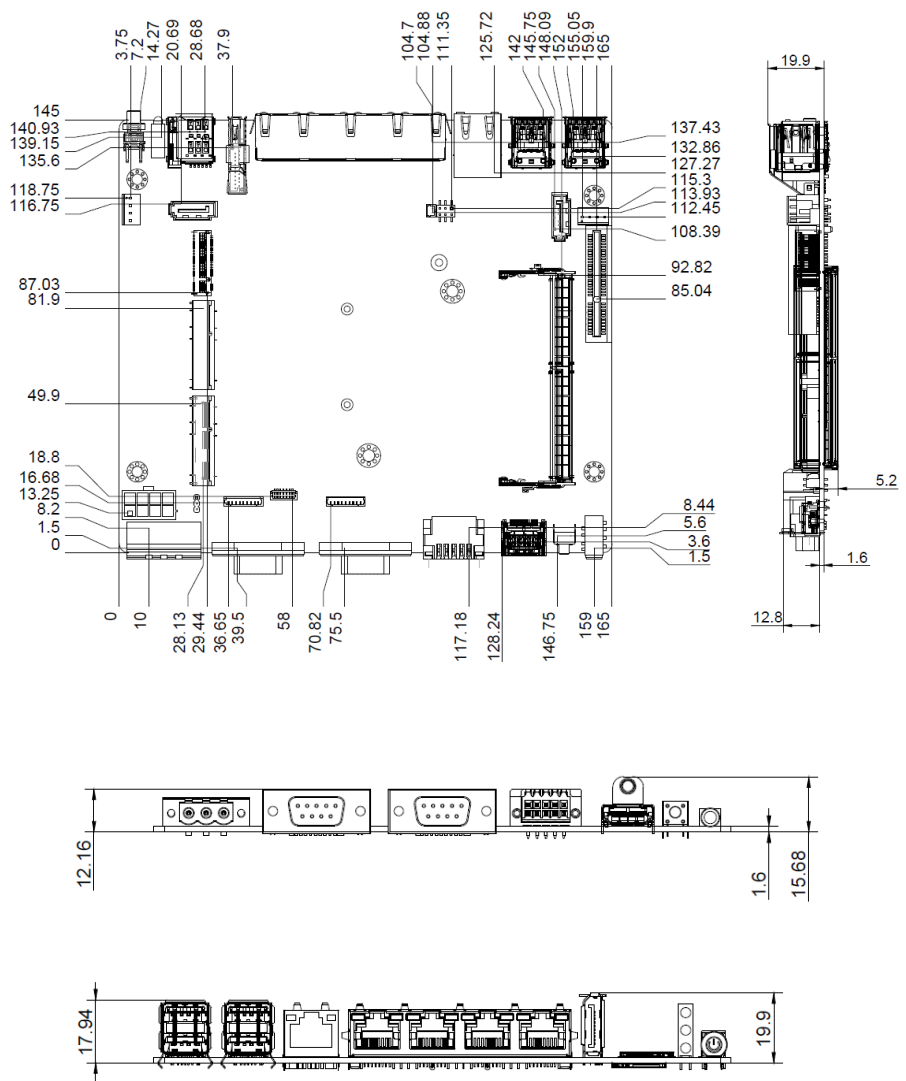

Solder side

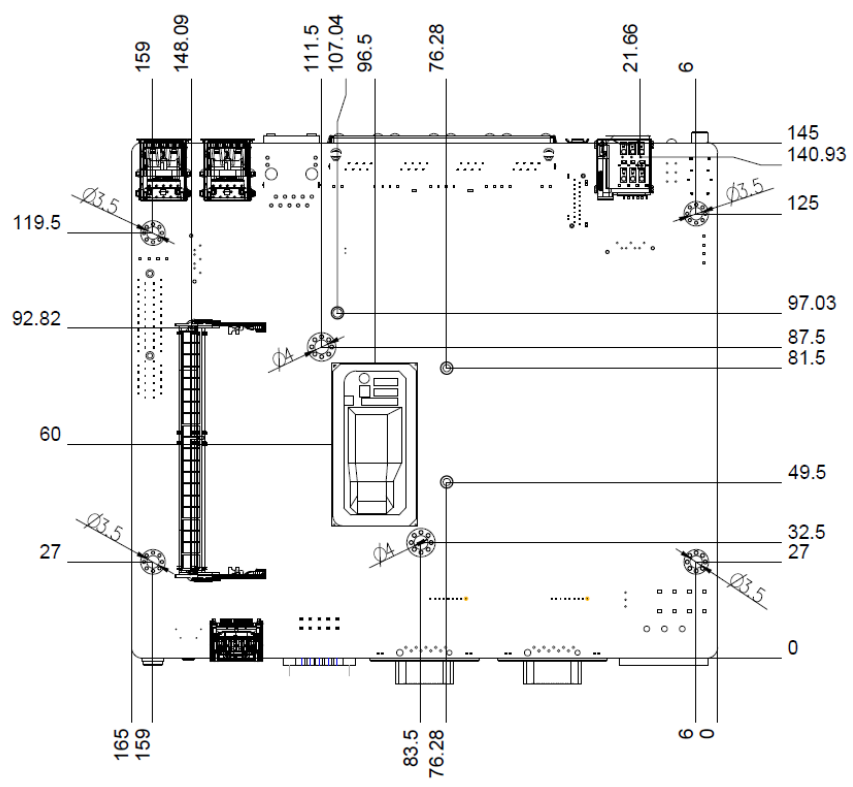

2.1.3 VPC-5620S with PER-T529 (COM Ports x 3) by Project

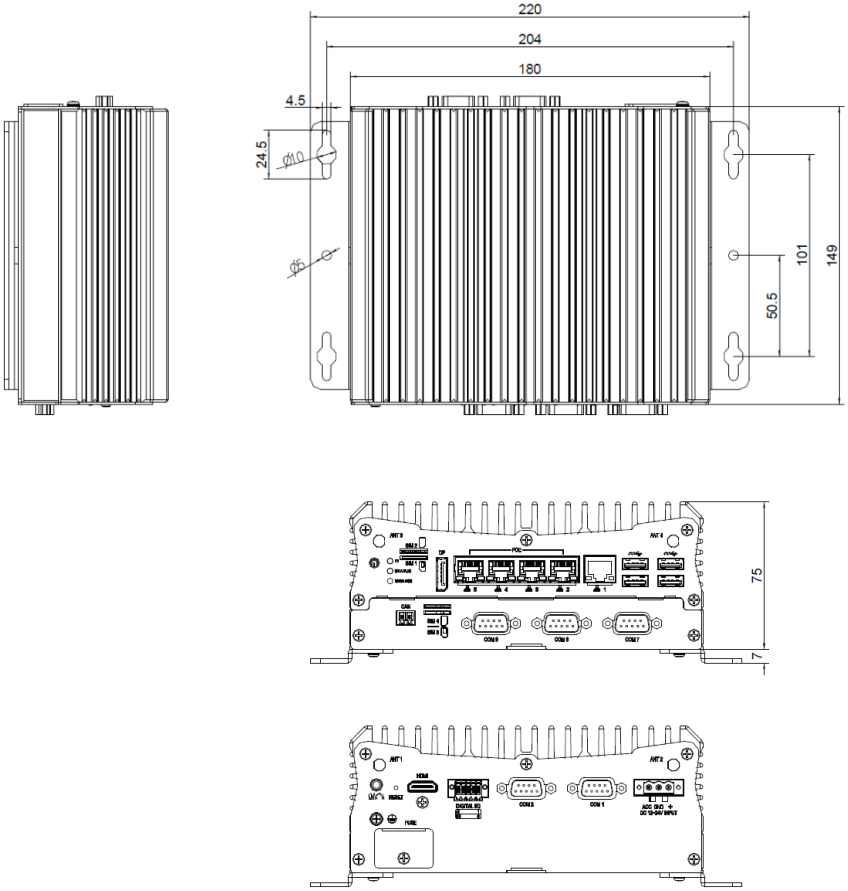

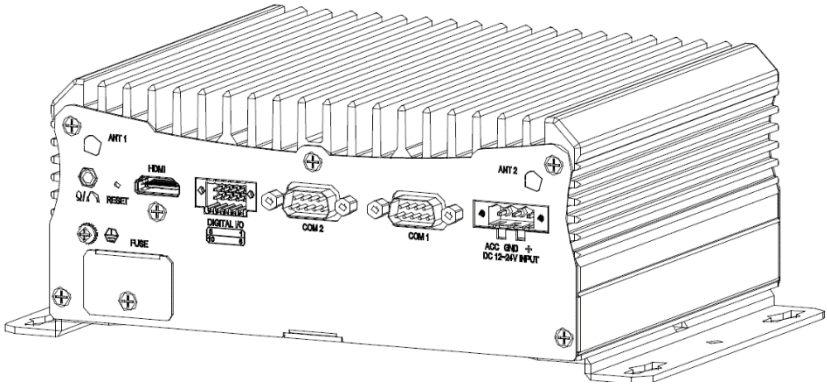
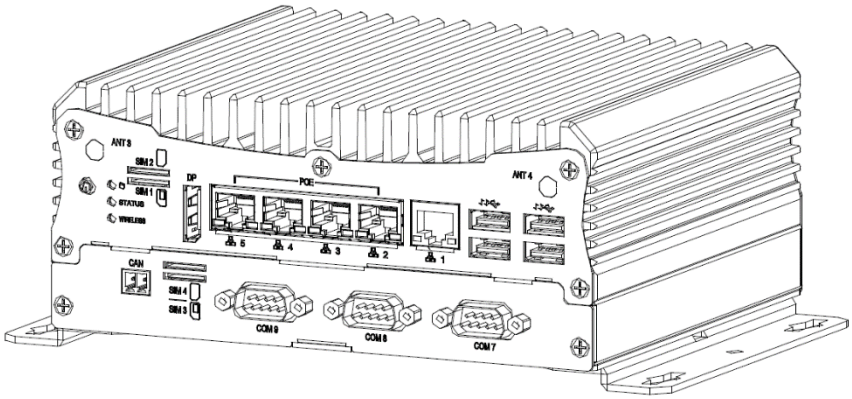

2.1.4 VPC-5620S with PER-T623 (USB Ports x 4) by Project

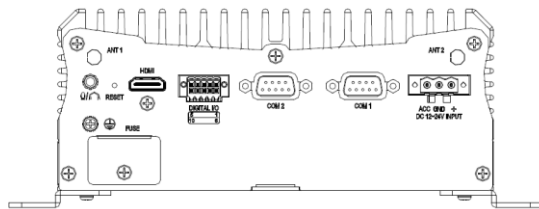
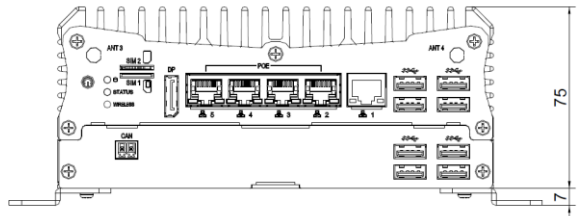
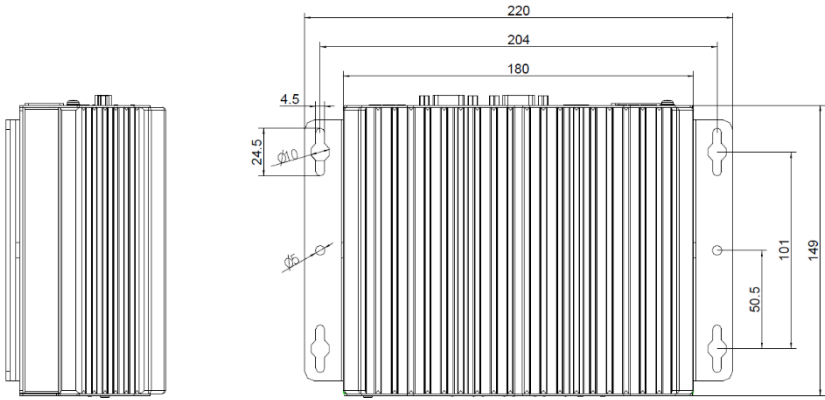

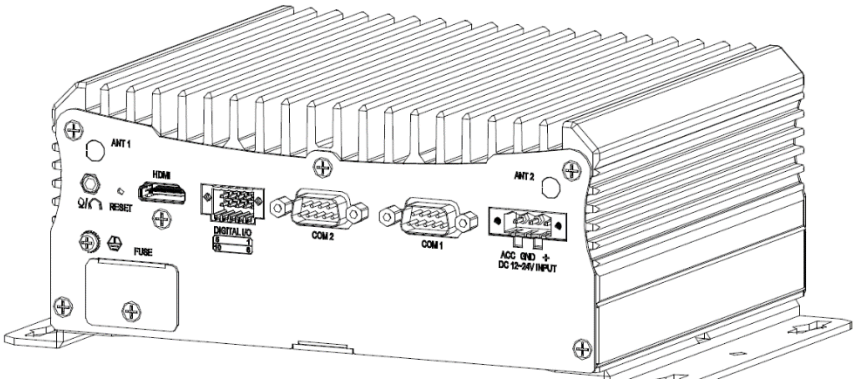
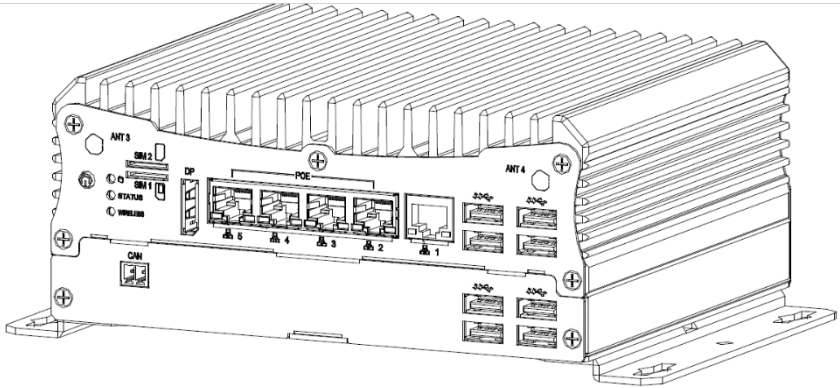

2.2 Jumpers and Connectors

Main Board Top

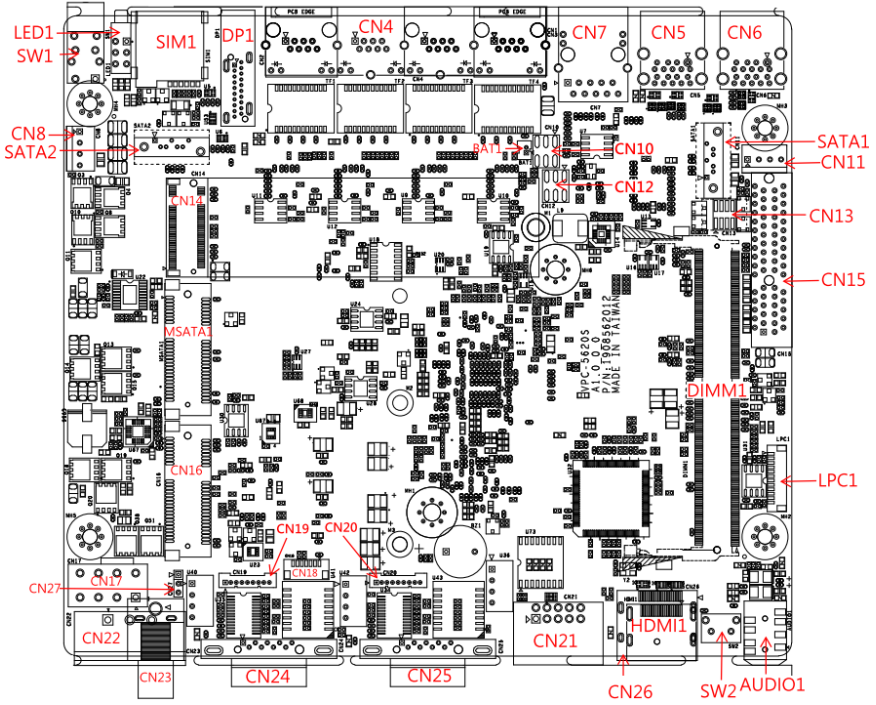

Main Board Bottom

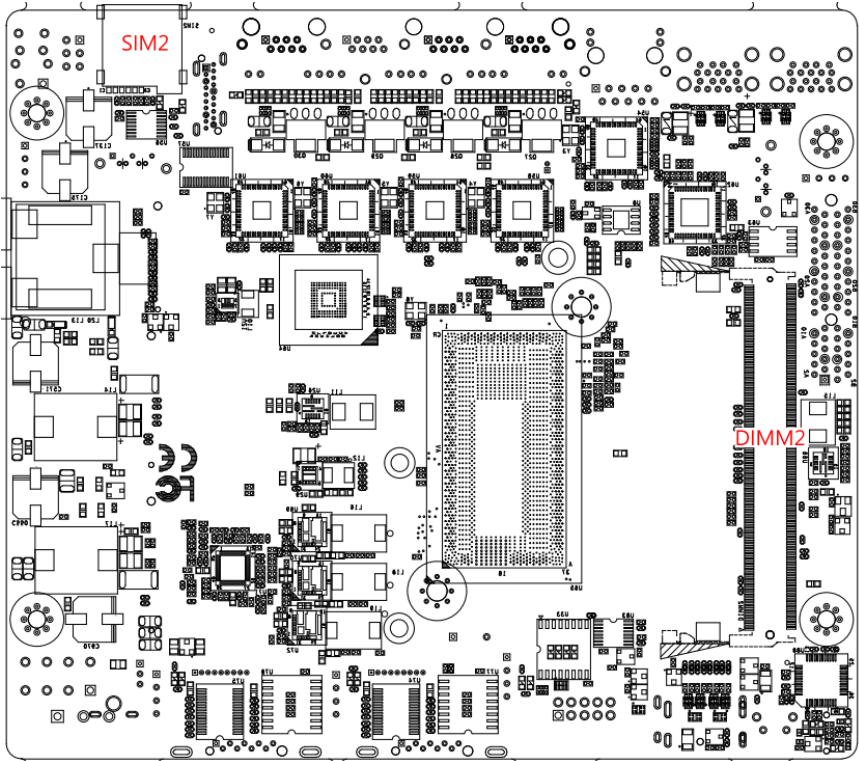

2.3 List of Jumpers

Please refer to the table below for all of the board's jumpers that you can configure for your application

Label	Function
CN10	Clear CMOS
CN12	Front Panel
CN27	DCIN Select Header (by Power Board or DCIN)

2.3.1 Clear CMOS (CN10)

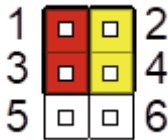

Pins 1-3 and 2-4
Normal (Default)

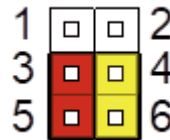

Pins 3-5 and 4-6
Clear CMOS

Note: To prevent damage or unwanted operation, do not use any other configuration than what is shown in this diagram

2.3.2 Front Panel (CN12)

Pin Selection	Function
1-2 Open	For Box PC Operation
1-2 Closed	For In-Vehicle PC Operation

2.3.3 DCIN Select Header (CN27)

Note: This jumper set selects whether the VPC-5620S is powered by DCIN port or by Power Board.

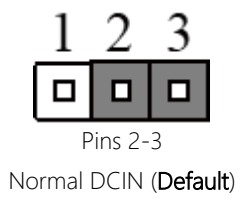
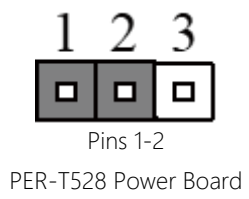

2.4 List of Connectors

Please refer to the table below for all of the board's connectors that you can configure for your application

Label	Function
Audio1	Audio Front & Mic Connector
BAT1	Battery Connector
CN4	Ethernet 2~5 with POE
CN5	Dual USB3.1 Ports
CN6	Dual USB3.1 Ports
CN7	Ethernet 1 (no PoE)
CN8	SATA Power
CN11	SATA Power
CN13	For Bios Debug
CN14	M.2 M-Key 2280 Slot (Supports PCIe [x4] and SATA)
CN15	Expansion Board Connector
CN16	Mini Card Slot (Full Function) paired to SIM1
CN17	Vehicle Power Board Expansion Connector
CN18	Vehicle Power Board Expansion Connector
CN19	Serial Port4 (RS232)
CN20	Serial Port 3(RS232)
CN21	DIO Connector
CN22	DCIN (Default) †
CN23	DCIN (Option) †
CN24	Serial Port1 (RS232/422/485)
CN25	Serial Port2 (RS232/422/485)
CN26	Display Port 2 (Option) †

Label	Function
DIMM1	DDR4 SODIMM
DIMM2	DDR4 SODIMM
DP1	Display Port 1
HDMI1	HDMI Connector (Default) †
LED1	HDD/Status/CN16-WLAN LED
LPC1	For Debug
MSATA1	mSATA Slot (SATA+USB2.0) paired to SIM2 †
SATA1	SATA Connector
SATA2	SATA Connector †
SW1	Power Button
SW2	Software Reset Button

†Note: These connectors have optional co-lay/ signal sharing configurations as follows:

1. SATA2 standard config; mSATA slot optional, utilizes the SATA2 signal
2. CN22 standard config; CN23 is co-lay option (board will only have CN22 or CN23)
3. HDMI1 is standard config; CN26 is co-lay optional (board will only have HDMI1 or CN26)

2.4.1 SATA Power Connector (CN8/CN11)

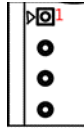

Pin	Signal	Pin	Signal
1	NA	2	GND
3	GND	4	+5V

2.4.2 Front Panel Connector (CN12)

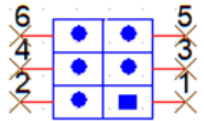

Pin	Signal	Pin	Signal
1	PWR_SW#	2	FPANSWH#
3	GND	4	HWRST#
5	GND	6	FPANSWH#

2.4.3 Expansion Board Connector (CN15)

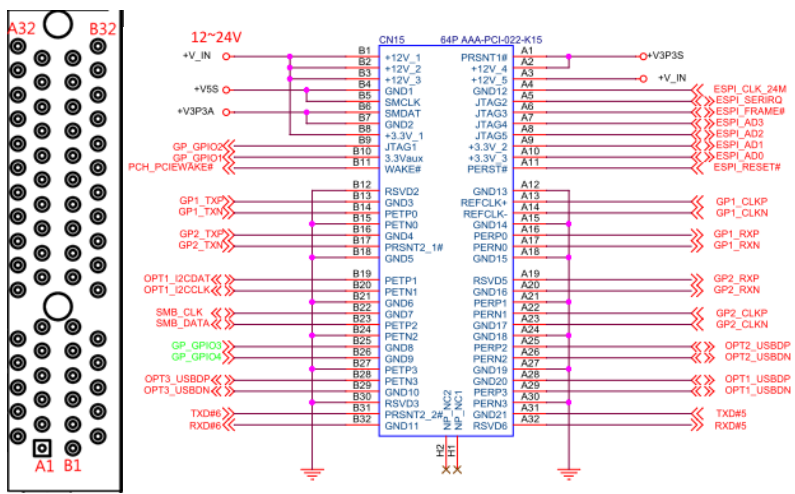

2.4.4 Vehicle Power Board Expansion Connector (CN17)

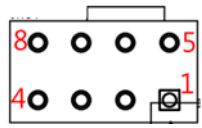

Pin	Signal	Pin	Signal
1	Ground	2	DCIN
3	Ground	4	DCIN
5	Ground	6	V-out (by PER-T528)
7	Ground	8	V-out (by PER-T528)

2.4.5 Vehicle Power Board Expansion Connector (CN18)

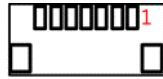

Pin	Signal	Pin	Signal
1	ACC_IN	2	PWRBD_EN
3	PS_ON#	4	REMOTE_SW
5	PWR_SW#	6	RXD
7	TXD	8	

2.4.6 RS-232 Serial Port 3/ 4 Connector (CN19/CN20)

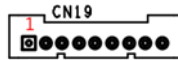

Pin	Signal	Pin	Signal
1	DCD	2	DSR
3	RXD	4	RTS
5	TXD	6	CTS
7	DTR	8	RI
9	GND		

2.4.7 Digital I/O Connector (CN21)

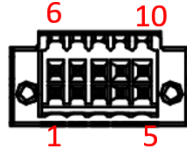

Pin	Signal	Pin	Signal
1	GND	2	GP-In0
3	GP-In1	4	GP-In2
5	GP-In3	6	+5V
7	GP-Out0	8	GP-Out1
9	GP-Out2	10	GP-Out3

2.4.8 DC Input (12~24V) (CN22)

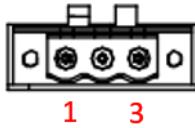

Pin	Signal
1	DCIN
2	GND
3	ACC

2.4.9 RS-232 Serial Port 1/ 2 Connector (CN24/CN25)

Pin	Signal	RS485	RS422	Pin	Signal	RS485	RS422
1	DCD	DATA-	TX-	2	DSR		
3	RXD	DATA+	TX+	4	RTS		
5	TXD		RX+	6	CTS		
7	DTR		RX-	8	RI		
9	GND						

Note: Table shows default Pin settings for RS422 and RS485.

2.4.10 Software Reset Switch (SW2)

SW2 is a Software Programmable Button. GPIO Mapping/Pin Mapping is SIO GPIO76 by FinTEK.

Status: Open = 1 / Close = 0

2.5 Block Diagram

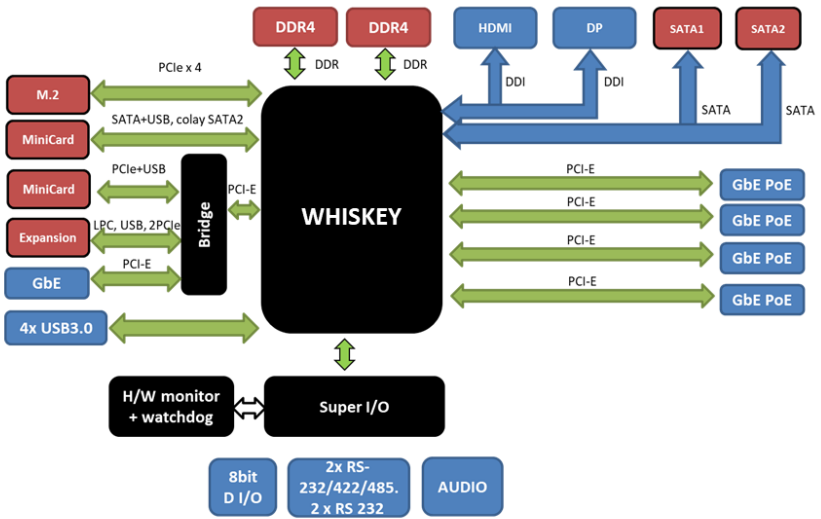

2.6 PER-T528 Power Expansion Board

2.6.1 PER-T528 Jumpers and Connectors

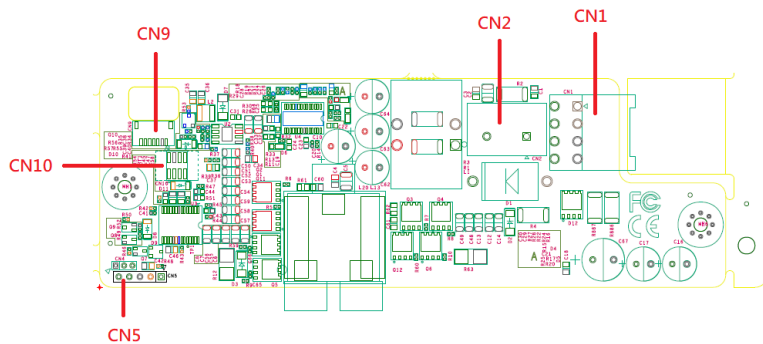

2.6.2 PER-T528 List of Connectors

Label	Function
CN1	Power Connector to VPC-5620S
CN2	Fuse Connector
CN5	MCU Programming Pin
CN9	Communication Pin Connector (connect to VPC-5620S)
CN10	Communication Pin Header (connect to VPC-5620S; PER-T528 A03 not used)

2.6.2.1 Power Connector (CN1)

Pin	Signal	Pin	Signal
1	GND	2	GND
3	GND	4	GND
5	Vin	6	Vin
7	Vout	8	Vout

2.6.2.2 MCU Programming Pin (CN5)

Pin	Signal	Pin	Signal
1	#MCLR	2	VCC
3	GND	4	ICSPDTA
5	ICSPCLK		

2.6.2.3 Communication Pin Connector (CN9)

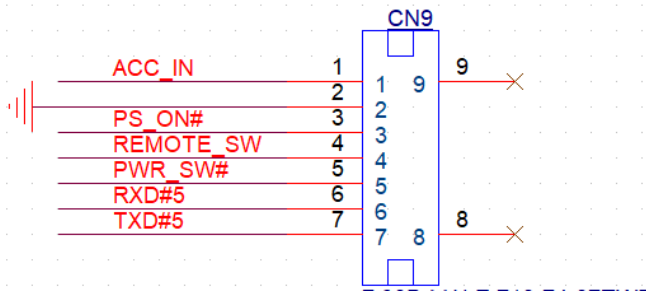

Pin	Signal	Pin	Signal
1	ACC_IN	2	GND
3	PS_ON#	4	REMOTE_SW
5	PWR_SW#	6	RXD#5
7	TXD#5		

2.6.2.4 Communication Pin Header (CN10)

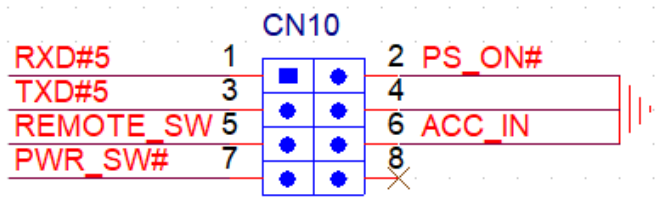

Pin	Signal	Pin	Signal
1	RXD#5	2	PS_ON#
3	TXD#5	4	GND
5	REMOTE_SW	6	ACC_IN
7	PWR_SW#	8	NC

2.7 PER-T529 In-Vehicle Expansion Board

2.7.1 PER-T529 Jumpers and Connectors

Top View

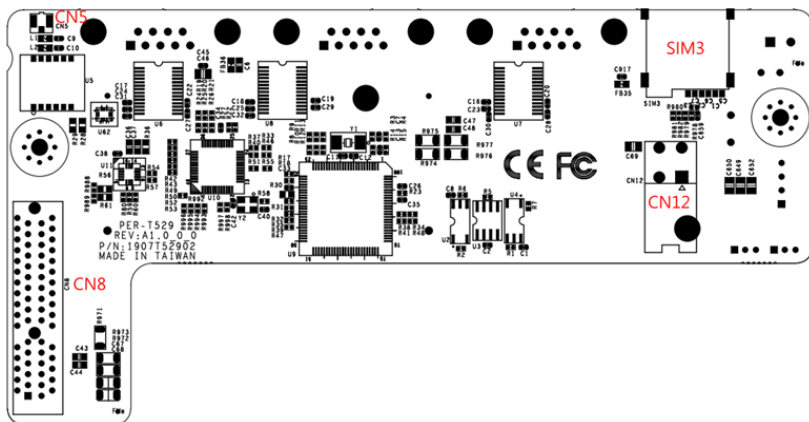

Bottom View

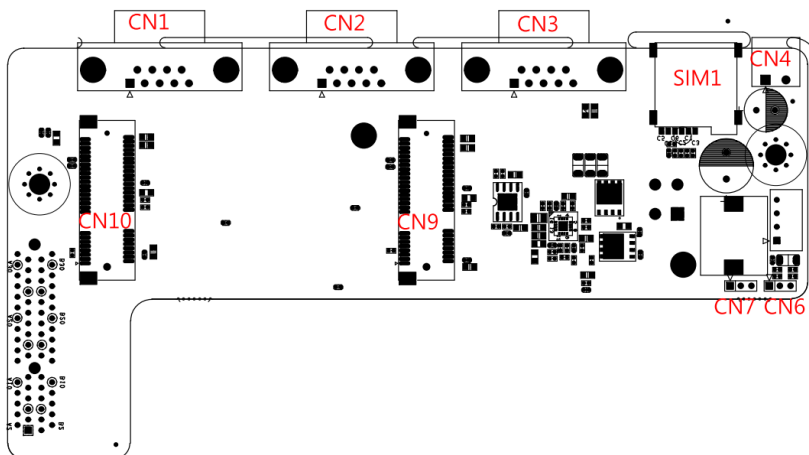

2.7.2 PER-T529 List of Jumpers

Label	Function
CN6	Reserved for Debug
CN7	Reserved for Debug

2.7.2.1 Reserved for Debug (CN6)

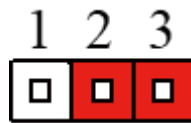

2.7.2.2 Reserved for Debug (CN7)

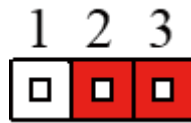
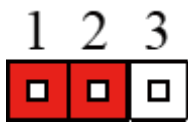

2.7.3 PER-T529 List of Connectors

Label	Function
CN1	Serial Port 1 (RS232 only)
CN2	Serial Port 2 (RS232 only)
CN3	Serial Port 3 (RS232 only)
CN4	Can Bus Connector
CN5	GPS Antenna Connector
CN8	Board to Board Connector
CN9	Mini Card Slot (Full Function) paired to SIM3
CN10	Mini Card Slot (Full Function) paired to SIM1
CN12	Power Input Connector (Option)

2.7.3.1 CAN Bus Connector (CN4)

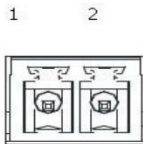

Pin	Signal	Pin	Signal
1	CAN DATA+	2	CAN DATA-

2.7.3.2 Board to Board Connector (CN8)

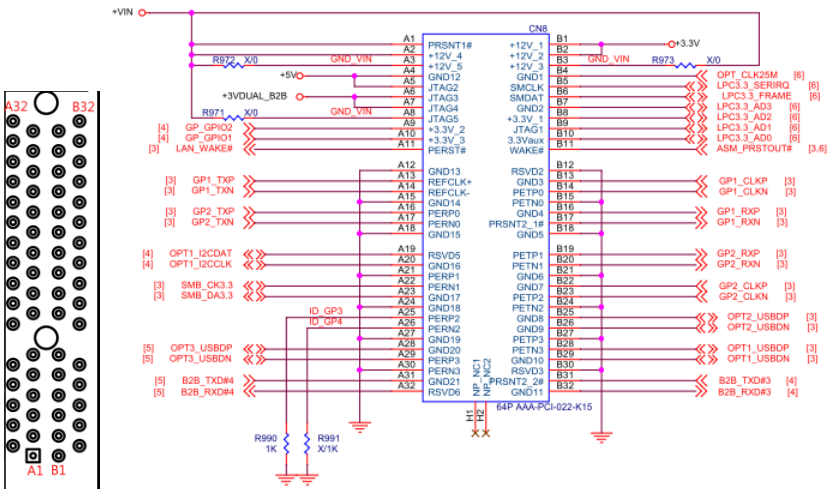

2.7.3.3 Power Connection (CN12)



Pin	Signal	Pin	Signal
1	GND	2	GND
3	PWR IN	4	PWR IN

Note: For Mini Card AI Modules, CN12 uses greater than 15W of power.

2.8 System Assembly (Industrial Chassis)

2.8.1 2.5" SATA Drive and Bottom Panel Assembly

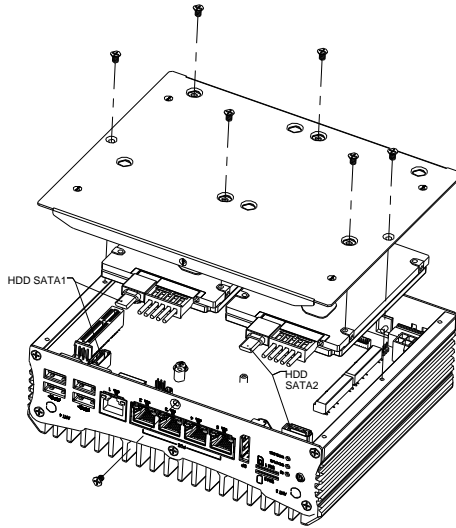

Front/PoE View. Note orientation of 2.5" SATA drive connectors

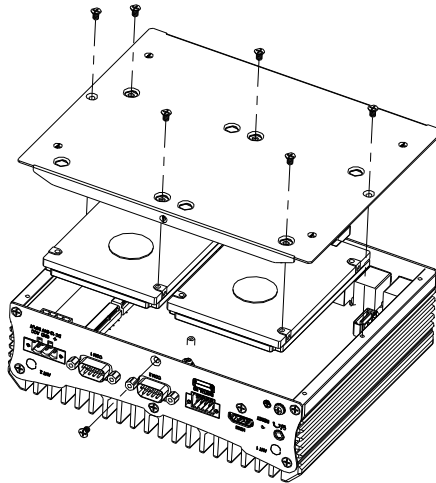

Rear/COM Port View

2.8.2 Wall Mount Assembly

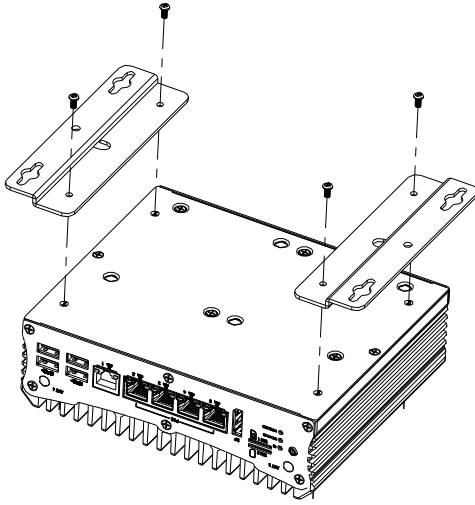

2.9 System Assembly (Expanded Chassis)

2.9.1 2.5" SATA Drive and Bottom Panel Assembly

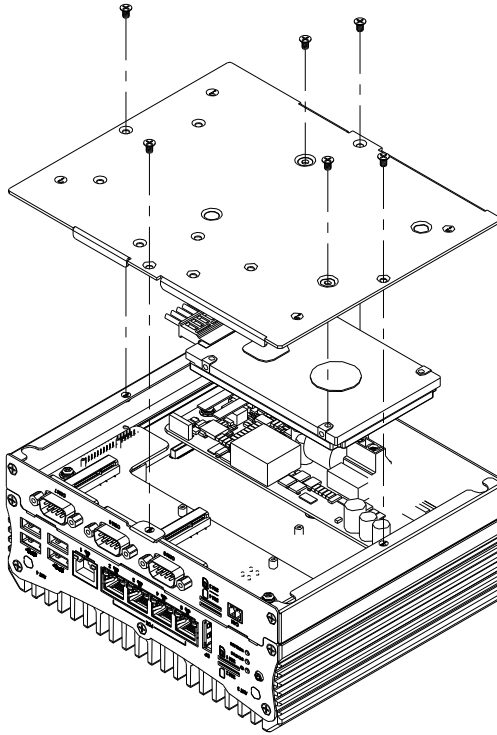

Front/System PoE View. Note the orientation of the SATA drive cables

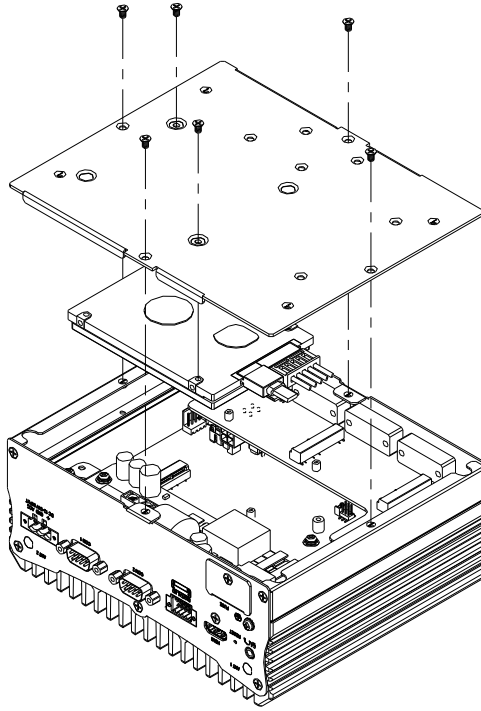

Rear System View. Note the orientation of the SATA drive cables

2.9.2 RAM Installation

Step One: Remove IO Faceplate

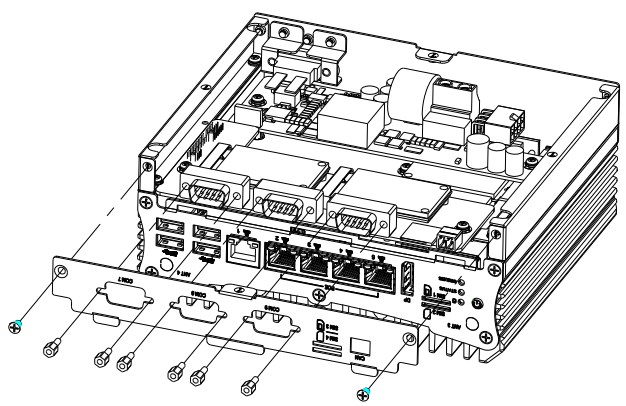

Step Two: Remove Daughter Board; DDR4 slot is located on same sides as USB Ports

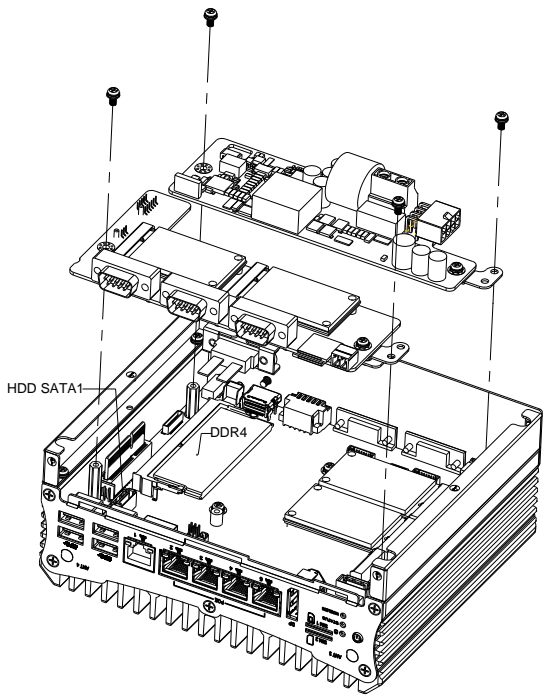

Alternate view for step 2:

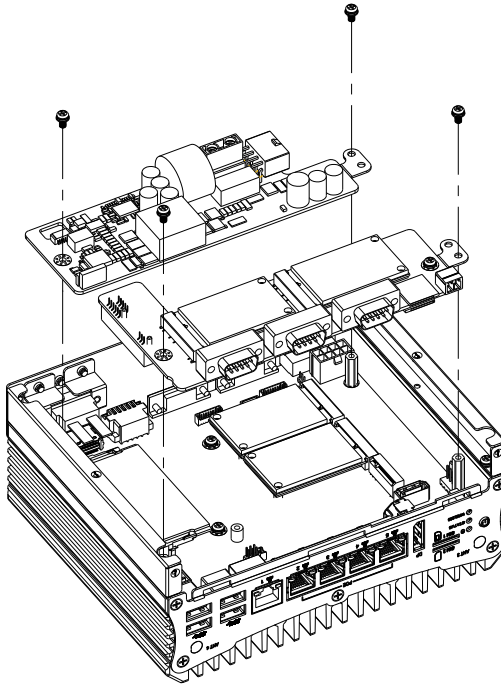

Reassemble in reverse, making sure to secure each daughter board and the faceplate.

2.9.3 Wall Mount Assembly

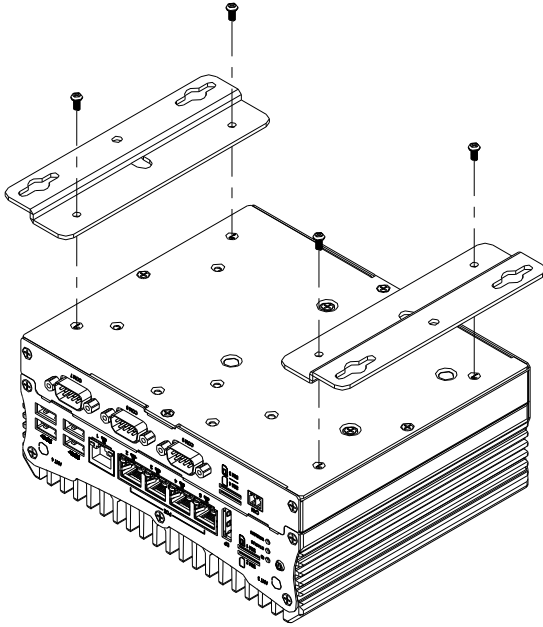

Chapter 3

AMI BIOS Setup

3.1 System Test and Initialization

The system uses certain routines to perform testing and initialization during the boot up sequence. If an error, fatal or non-fatal, is encountered, the system will output a few short beeps or an error message. The board can usually continue the boot up sequence with non-fatal errors.

The system configuration verification routines check the current system configuration against the values stored in the CMOS memory. If they do not match, an error message will be output, and the BIOS setup program will need to be run to set the configuration information in memory.

There are three situations in which the CMOS settings will need to be set or changed:

- Starting the system for the first time
- The system hardware has been changed
- The CMOS memory has lost power and the configuration information is erased

The system's CMOS memory uses a backup battery for data retention. The battery must be replaced when it runs down.

3.2 AMI BIOS Setup

The AMI BIOS ROM has a pre-installed Setup program that allows users to modify basic system configurations, which is stored in the battery-backed CMOS RAM and BIOS NVRAM so that the information is retained when the power is turned off.

To enter BIOS Setup, press or <F2> immediately while your computer is powering up.

The function for each interface can be found below.

Main – Date and time can be set here. Press <Tab> to switch between date elements

Advanced – Access and configure advanced processor options and features.

Chipset – Chipset and host bridge options and features

Security – The setup administrator password can be set here

Boot – Set boot options including boot priority and Quiet Boot option

Save & Exit – Save your changes and exit the program

3.3 Setup Submenu: Main



3.4 Setup Submenu: Advanced

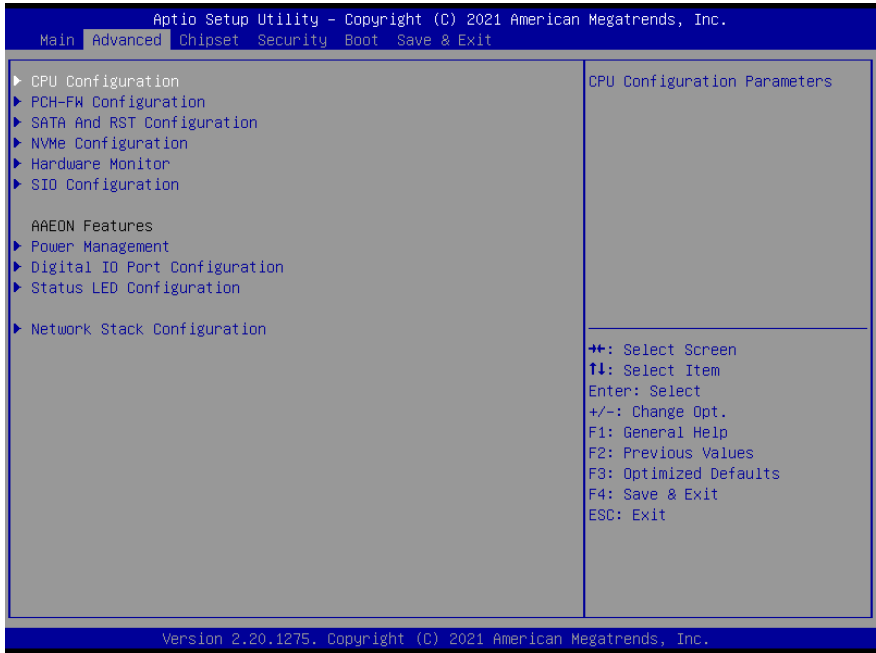

3.4.1 CPU Configuration

Aptio Setup Utility - Copyright (C) 2021 American Megatrends, Inc.

Advanced

CPU Configuration		Number of cores to enable in each processor package.
Type	Intel(R) Core(TM) i7-8665UE CPU @ 1.70GHz	
ID	0x806EC	
Stepping	V0	
Microcode Revision	CA	
Speed	2000 MHz	
L1 Data Cache	32 KB x 4	
L1 Instruction Cache	32 KB x 4	
L2 Cache	256 KB x 4	
L3 Cache	8 MB	
L4 Cache	N/A	
VMX	Supported	
SMX/TXT	Supported	
Active Processor Cores	[All]	
Hyper-Threading	[Enabled]	
		++: Select Screen T1: Select Item Enter: Select +/-: Change Opt. F1: General Help F2: Previous Values F3: Optimized Defaults F4: Save & Exit ESC: Exit

Version 2.20.1275. Copyright (C) 2021 American Megatrends, Inc.

Options Summary		
Active Processor Cores	All	Optimal Default, Failsafe Default
	1	
	2	
	3	
Number of cores to enable in each processor package.		
Hyper-Threading	Enabled	Optimal Default, Failsafe Default
	Disabled	
Enabled or disabled Hyper-Threading Technology.		

3.4.2 PCH-FW Configuration

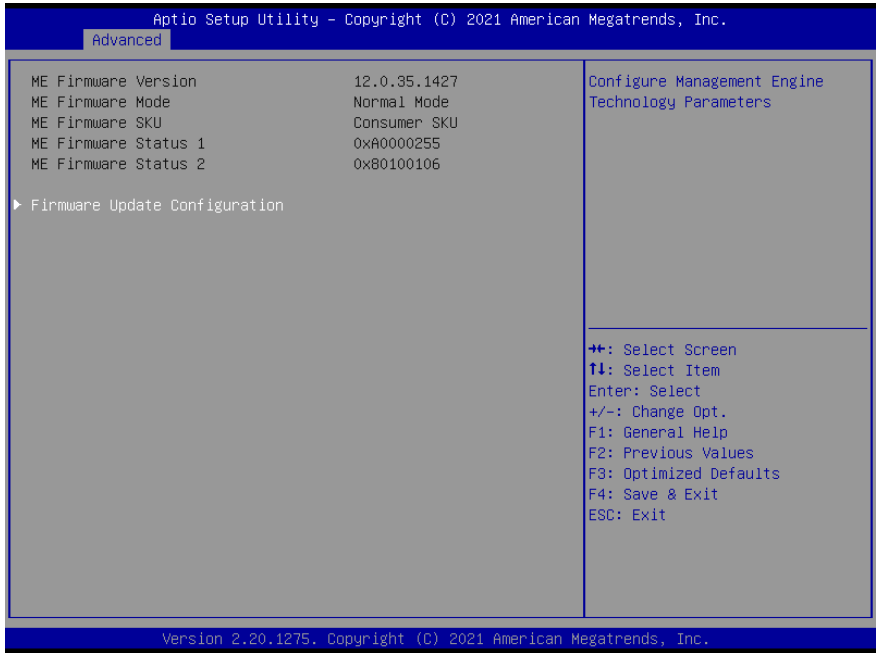

3.4.2.1 Firmware Update Configuration

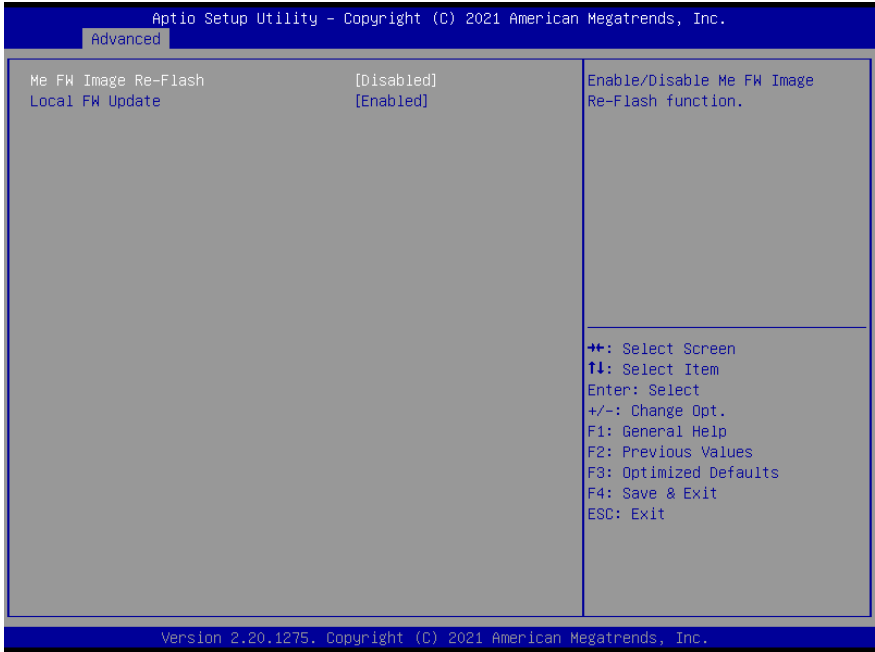

Options Summary		
ME FW Image Re-Flash	Enabled	Optimal Default, Failsafe Default
	Disabled	
Enable/Disable ME FW Image Re-Flash function.		
Local FW Update	Enabled	Optimal Default, Failsafe Default
	Disabled	
Options for Local FW Update function.		

3.4.3 SATA and RST Configuration

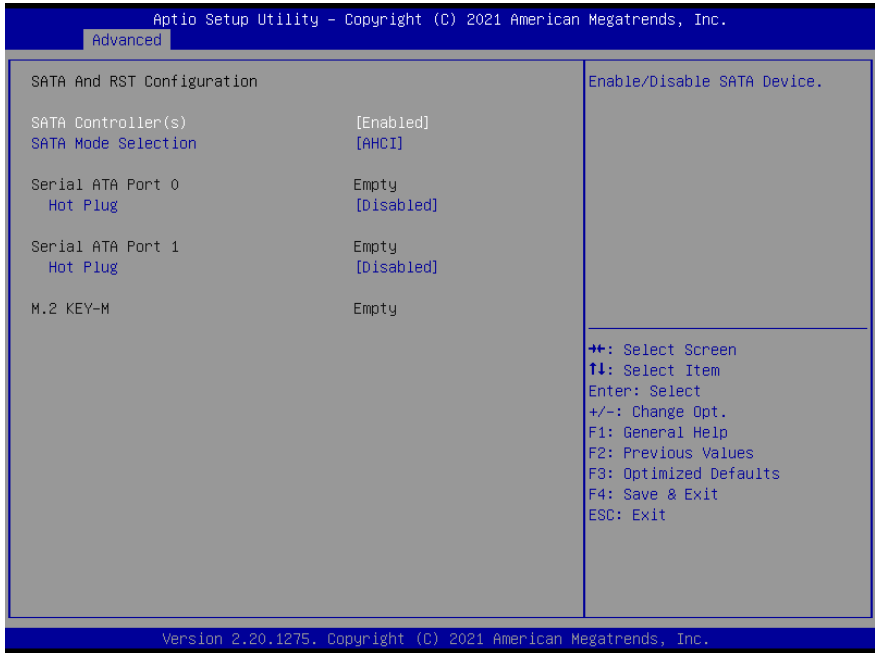

Options Summary		
SATA Controller(s)	Enabled	Optimal Default, Failsafe Default
	Disabled	
Enable/Disable SATA Device.		
SATA Mode Selection	AHCI	Optimal Default, Failsafe Default
	Intel RST Premium With Intel Optane System Acceleration	
	Determines how SATA controller(s) operate.	
Serial ATA Port 0 Hot Plug	Disabled	Optimal Default, Failsafe Default
	Enabled	
Designates this port as Hot Pluggable		
Serial ATA Port 1 Hot Plug	Disabled	Optimal Default, Failsafe Default
	Enabled	
Designates this port as Hot Pluggable		

3.4.4 NVMe Configuration

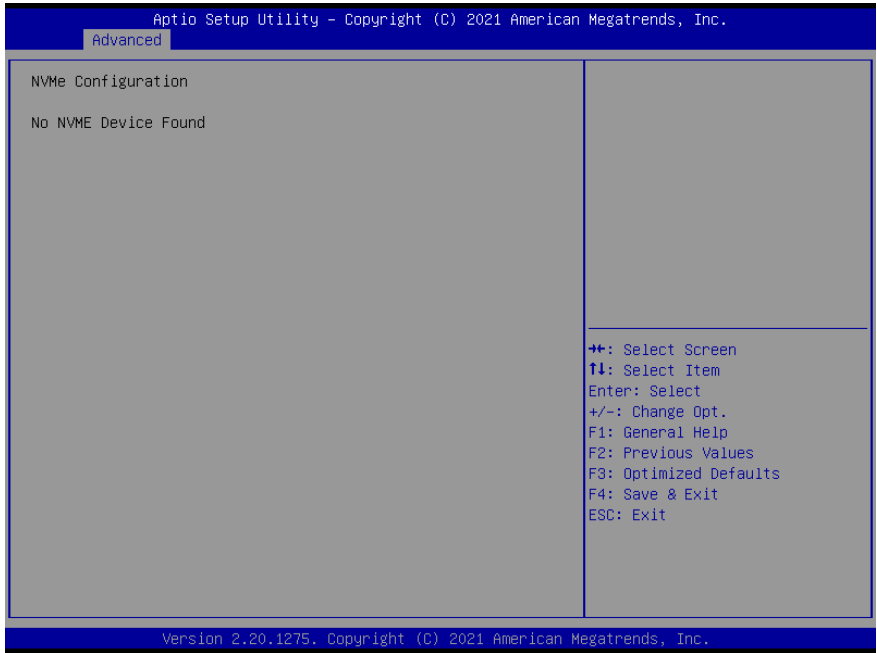

3.4.5 Hardware Monitor

Aptio Setup Utility - Copyright (C) 2021 American Megatrends, Inc.

Advanced

Pc Health Status

CPU Temperature	: +49 ℃
System Temperature	: +44 ℃
VDDCORE	: +0.744 V
VMEM	: +1.184 V
+5V	: +5.003 V
+3.3V	: +3.280 V
3VSB	: +3.312 V
5VSB	: +5.040 V
VBAT	: +3.088 V

++: Select Screen
↑↓: Select Item
Enter: Select
+/-: Change Opt.
F1: General Help
F2: Previous Values
F3: Optimized Defaults
F4: Save & Exit
ESC: Exit

Version 2.20.1275. Copyright (C) 2021 American Megatrends, Inc.

3.4.6 SIO Configuration

The screenshot shows the 'Advanced' configuration screen of the Aptio Setup Utility. The title bar reads 'Aptio Setup Utility - Copyright (C) 2021 American Megatrends, Inc.' and the current screen is 'Advanced'. The main content area is divided into two columns. The left column displays the 'AMI SIO Driver Version : A5.09.01' and the 'Super IO Chip Logical Device(s) Configuration'. Under this heading, there is a list of nine serial ports, each preceded by a right-pointing arrow and the text '[*Active*]'. The right column contains a descriptive text: 'View and Set Basic properties of the SIO Logical device. Like IO Base, IRQ Range, DMA Channel and Device Mode.' Below this, a legend lists navigation keys: '+*': Select Screen, 't1': Select Item, 'Enter': Select, '+/-': Change Opt., 'F1': General Help, 'F2': Previous Values, 'F3': Optimized Defaults, 'F4': Save & Exit, and 'ESC': Exit. A warning message is located at the bottom of the left column: 'WARNING: Logical Devices state on the left side of the control, reflects the current Logical Device state. Changes made during Setup Session will be shown after you restart the system.' The footer of the screen reads 'Version 2.20.1275. Copyright (C) 2021 American Megatrends, Inc.'

```
Aptio Setup Utility - Copyright (C) 2021 American Megatrends, Inc.
Advanced

AMI SIO Driver Version : A5.09.01

Super IO Chip Logical Device(s) Configuration
▶ [*Active*] Serial Port 1
▶ [*Active*] Serial Port 2
▶ [*Active*] Serial Port 3
▶ [*Active*] Serial Port 4
▶ [*Active*] Serial Port 5
▶ [*Active*] Serial Port 6
▶ [*Active*] Serial Port 7
▶ [*Active*] Serial Port 8
▶ [*Active*] Serial Port 9

WARNING: Logical Devices state on the left side of the
control, reflects the current Logical Device state. Changes
made during Setup Session will be shown after you restart
the system.

View and Set Basic properties
of the SIO Logical device.
Like IO Base, IRQ Range, DMA
Channel and Device Mode.

+*': Select Screen
t1': Select Item
Enter: Select
+/-: Change Opt.
F1: General Help
F2: Previous Values
F3: Optimized Defaults
F4: Save & Exit
ESC: Exit

Version 2.20.1275. Copyright (C) 2021 American Megatrends, Inc.
```

3.4.6.1 Serial Port 1 Configuration



Options Summary		
Use This Device	Enabled	Optimal Default, Failsafe Default
	Disabled	
Enable or Disable this Logical Device.		
Device resource settings	Use Automatic Settings	Optimal Default, Failsafe Default
	IO=3F8h; IRQ = 4;	
	IO=2F8h; IRQ = 3;	
Allows the user to change the device resource settings. New settings will be reflected on this setup page after system restarts.		
UART selection	RS232	Optimal Default, Failsafe Default
	RS422	
	RS485	
UART RS232, 422, 485 selection.		

3.4.6.2 Serial Port 2 Configuration

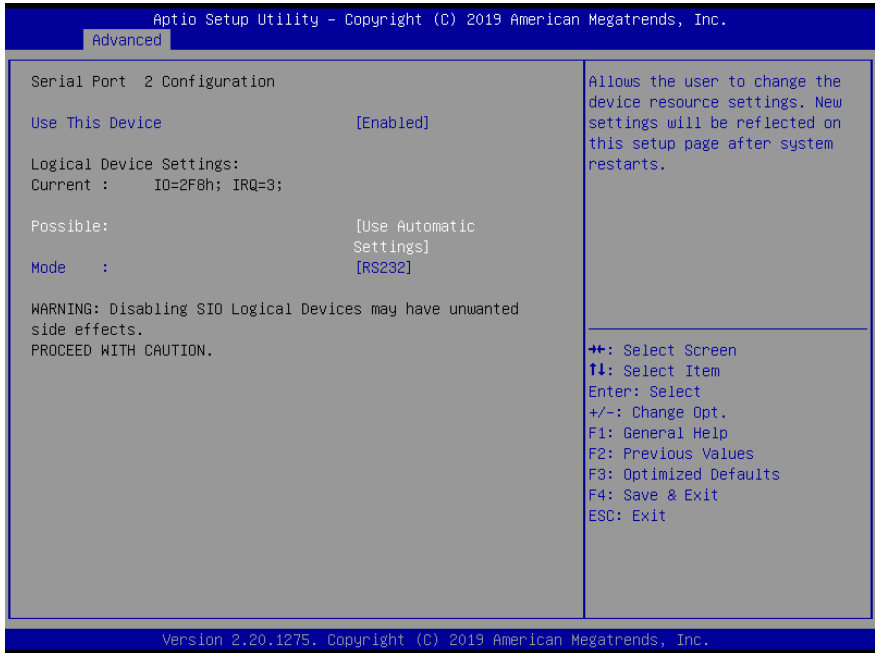

Options Summary		
Use This Device	Enabled	Optimal Default, Failsafe Default
	Disabled	
Enable or Disable this Logical Device.		
Device resource settings	Use Automatic Settings	Optimal Default, Failsafe Default
	IO=2F8h; IRQ = 3;	
	IO=3F8h; IRQ = 4;	
Allows the user to change the device resource settings. New settings will be reflected on this setup page after system restarts.		
UART selection	RS232	Optimal Default, Failsafe Default
	RS422	
	RS485	
UART RS232, 422, 485 selection.		

3.4.6.3 Serial Port 3 Configuration

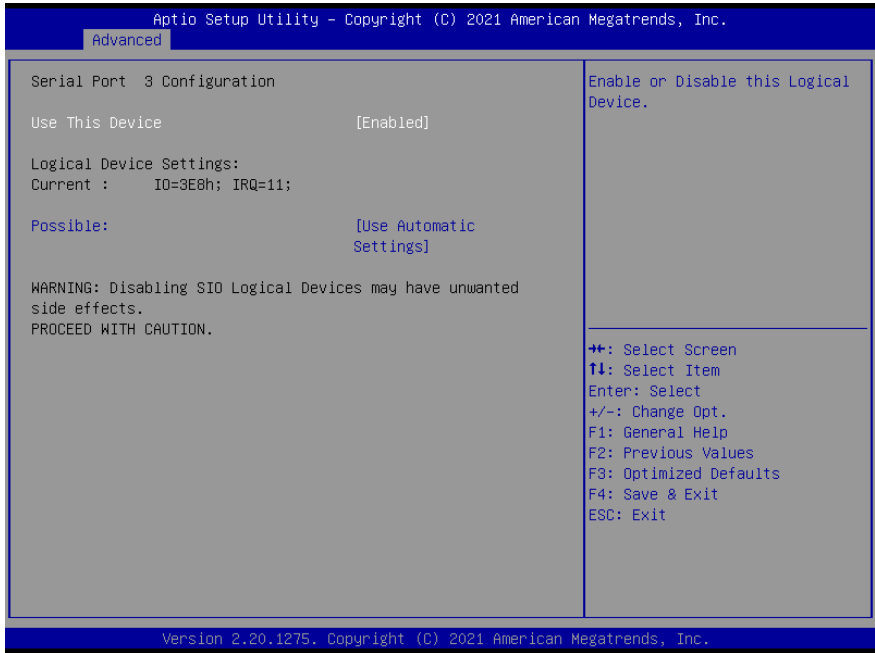

Options Summary		
Use This Device	Enabled	Optimal Default, Failsafe Default
	Disabled	
Enable or Disable this Logical Device.		
Device resource settings	Use Automatic Settings	Optimal Default, Failsafe Default
	IO=3E8h; IRQ = 11;	
	IO=2E8h; IRQ = 11;	
Allows the user to change the device resource settings. New settings will be reflected on this setup page after system restarts.		

3.4.6.4 Serial Port 4 Configuration

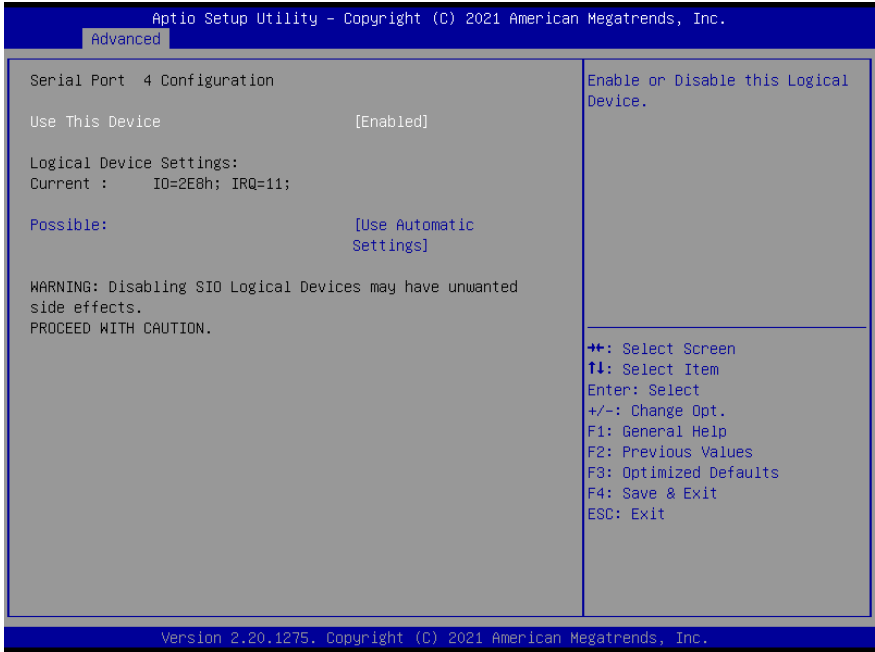

Options Summary		
Use This Device	Enabled	Optimal Default, Failsafe Default
	Disabled	
Enable or Disable this Logical Device.		
Device resource settings	Use Automatic Settings	Optimal Default, Failsafe Default
	IO=2E8h; IRQ = 11;	
	IO=3E8h; IRQ = 11;	
Allows the user to change the device resource settings. New settings will be reflected on this setup page after system restarts.		

3.4.6.5 Serial Port 5 Configuration

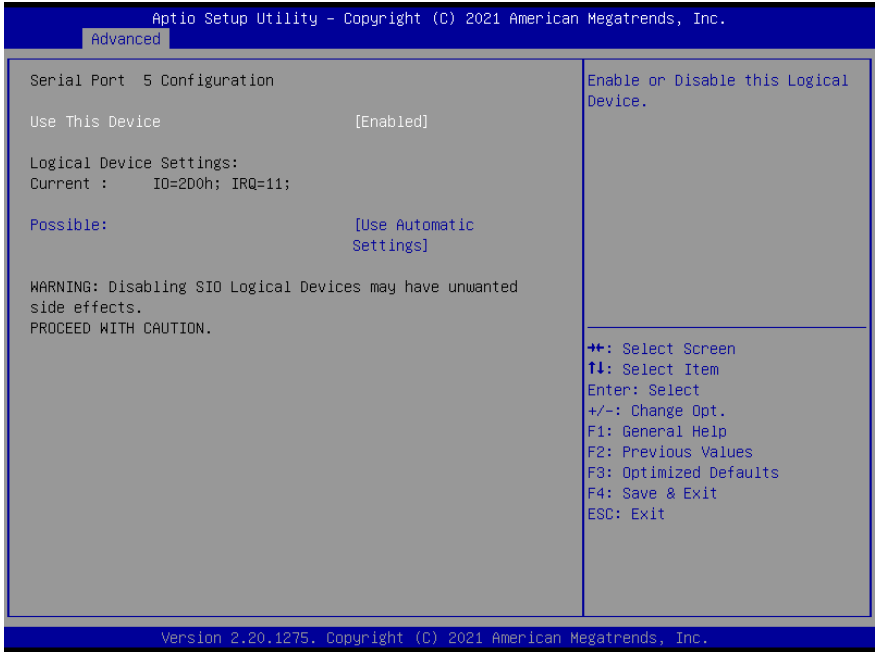

Options Summary		
Use This Device	Enabled	Optimal Default, Failsafe Default
	Disabled	
Enable or Disable this Logical Device.		
Device resource settings	Use Automatic Settings	Optimal Default, Failsafe Default
	IO=2D0h; IRQ = 11;	
	IO=2C0h; IRQ = 11;	
Allows the user to change the device resource settings. New settings will be reflected on this setup page after system restarts.		

3.4.6.6 Serial Port 6 Configuration

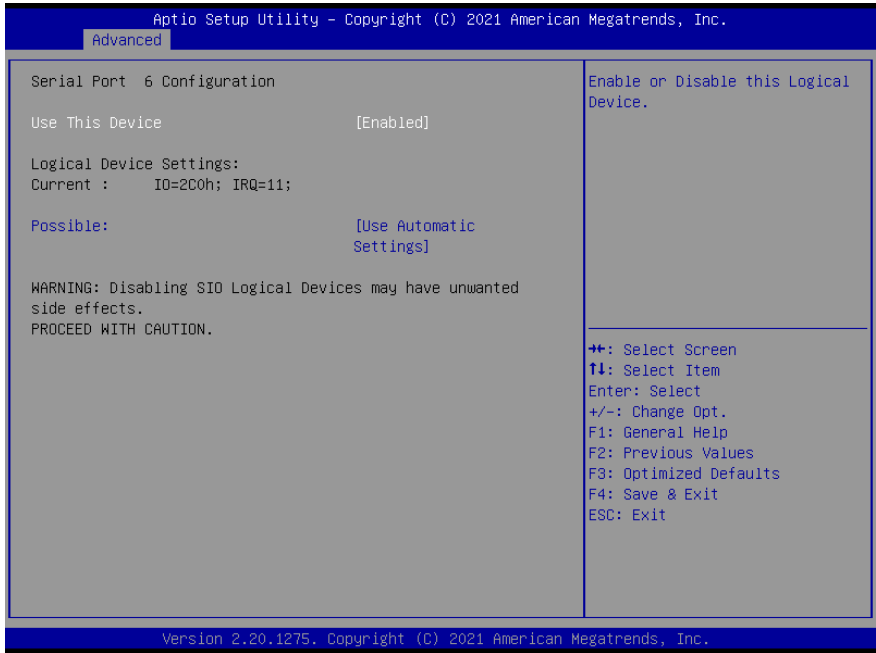

Options Summary		
Use This Device	Enabled	Optimal Default, Failsafe Default
	Disabled	
Enable or Disable this Logical Device.		
Device resource settings	Use Automatic Settings	Optimal Default, Failsafe Default
	IO=2C0h; IRQ = 11;	
	IO=2D0h; IRQ = 11;	
Allows the user to change the device resource settings. New settings will be reflected on this setup page after system restarts.		

3.4.6.7 Serial Port 7 Configuration

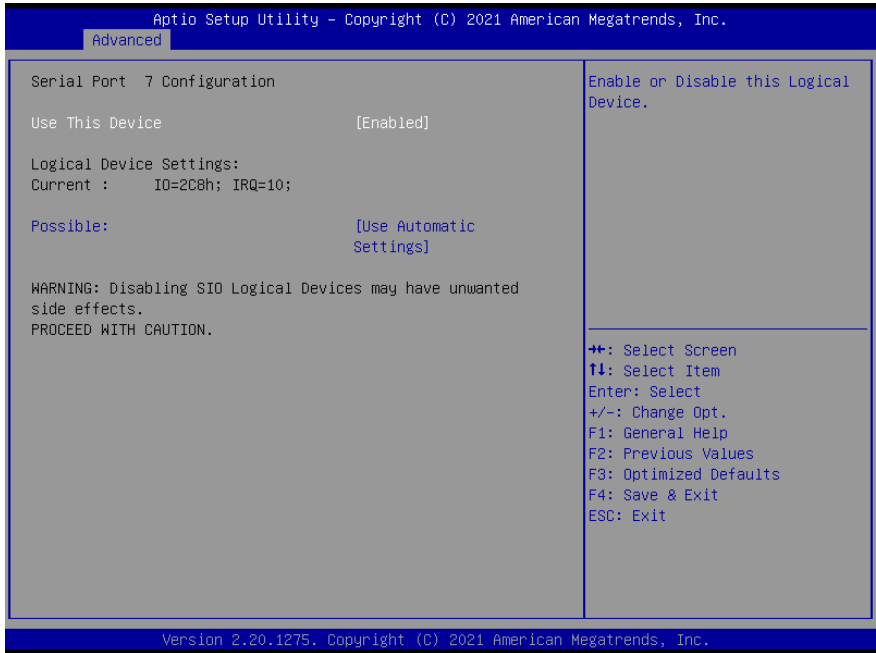

Options Summary		
Use This Device	Enabled	Optimal Default, Failsafe Default
	Disabled	
Enable or Disable this Logical Device.		
Device resource settings	Use Automatic Settings	Optimal Default, Failsafe Default
	IO=2C8h; IRQ = 10;	
	IO=2D8h; IRQ = 10;	
Allows the user to change the device resource settings. New settings will be reflected on this setup page after system restarts.		

3.4.6.8 Serial Port 8 Configuration

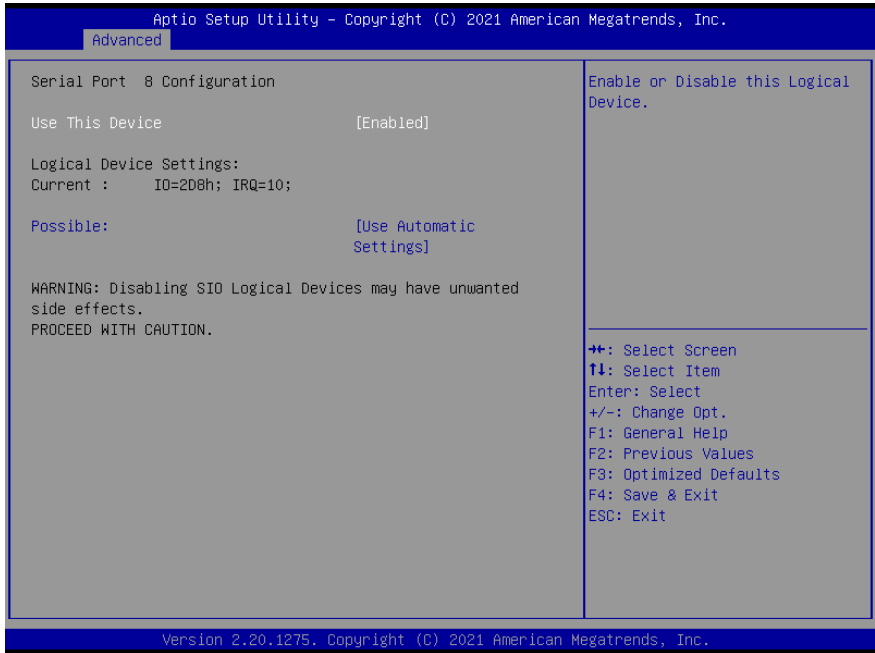

Options Summary		
Use This Device	Enabled	Optimal Default, Failsafe Default
	Disabled	
Enable or Disable this Logical Device.		
Device resource settings	Use Automatic Settings	Optimal Default, Failsafe Default
	IO=2D8h; IRQ = 11;	
	IO=2C8h; IRQ = 11;	
Allows the user to change the device resource settings. New settings will be reflected on this setup page after system restarts.		

3.4.6.9 Serial Port 9 Configuration

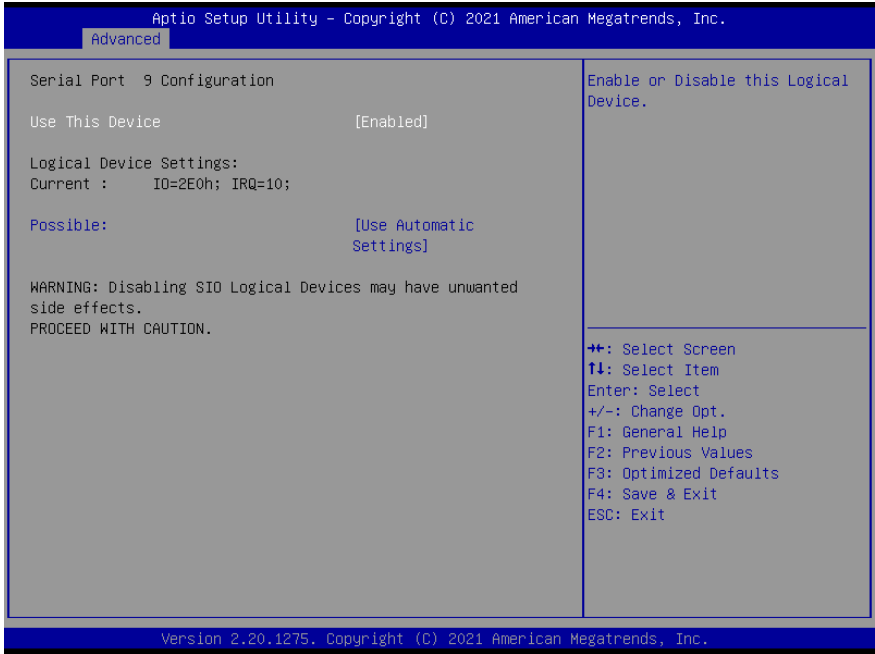

Options Summary		
Use This Device	Enabled	Optimal Default, Failsafe Default
	Disabled	
Enable or Disable this Logical Device.		
Device resource settings	Use Automatic Settings	Optimal Default, Failsafe Default
	IO=2E0h; IRQ = 10;	
	IO=2F0h; IRQ = 10;	
Allows the user to change the device resource settings. New settings will be reflected on this setup page after system restarts.		

3.4.7 Power Management

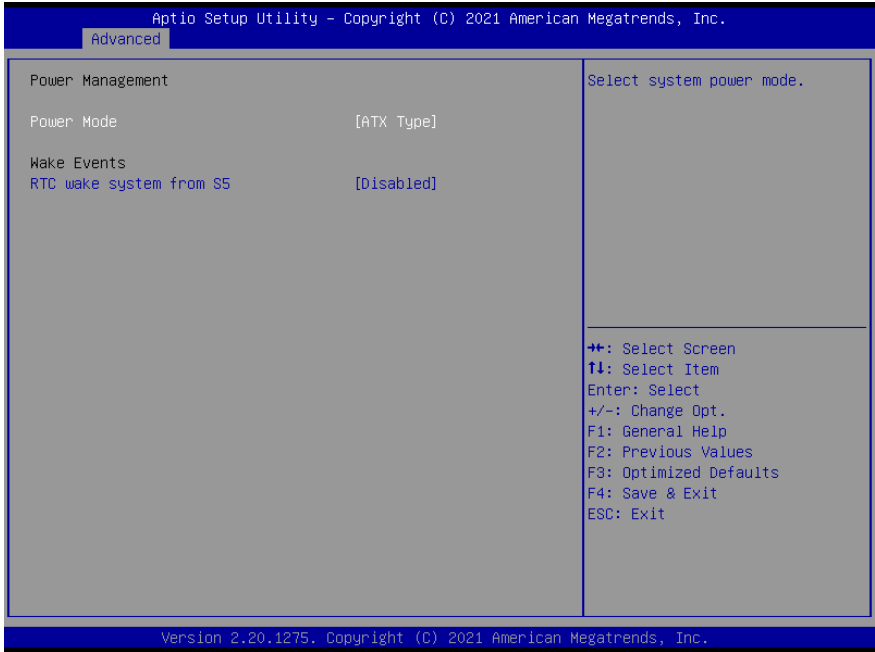

Options Summary		
Power Mode	ATX Type	Optimal Default, Failsafe Default
	AT Type	
Select power supply mode.		
RTC wake system from S5	Disabled	Optimal Default, Failsafe Default
	Enabled	
Fixed Time: System will make on the hr::min::sec specified. Dynamic Time: System will wake on the current time + Increase minute(s). Bypass: BIOS will not control RTC wake function during system shutdown.		
RTC wake system from S5	Enabled	
Wake up day	0	
Select 0 for daily system wake up, 1-31 for which day of the month that you would like the system to wake up		

Options Summary		
Wake up hour	0	
Select 0-23 For example enter 3 for 3am and 15 for 3pm		
Wake up minute	0	
0 - 59		
Wake up second	0	
0 - 59		

3.4.8 Digital IO Port Configuration

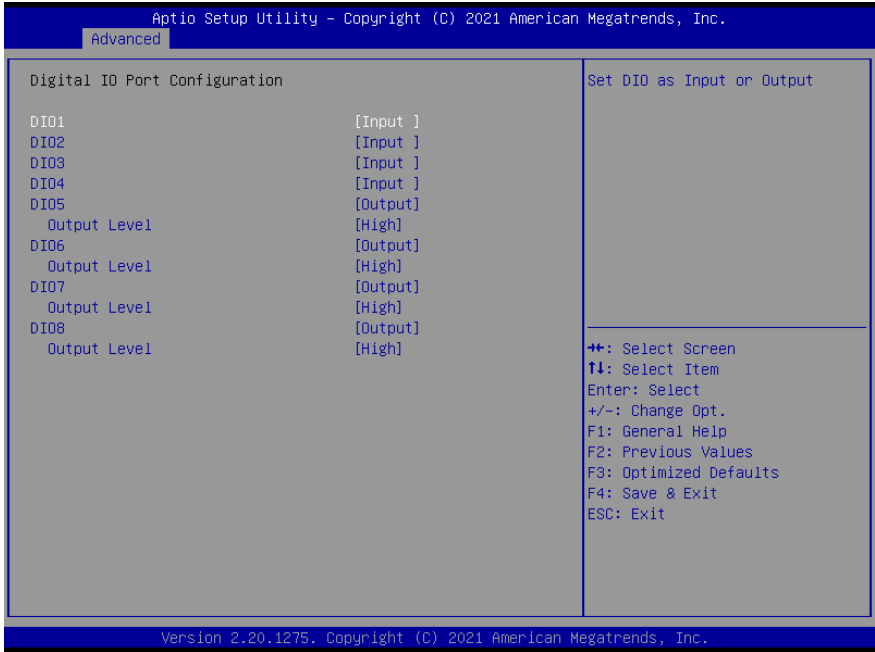

Options Summary		
DIO Type	Output	Optimal Default, Failsafe Default
	Input	
Set DIO as Input or Output		
DIO Data	Low	Optimal Default, Failsafe Default
	High	
Set is output level when DIO pin is output		

3.4.9 Status LED Configuration

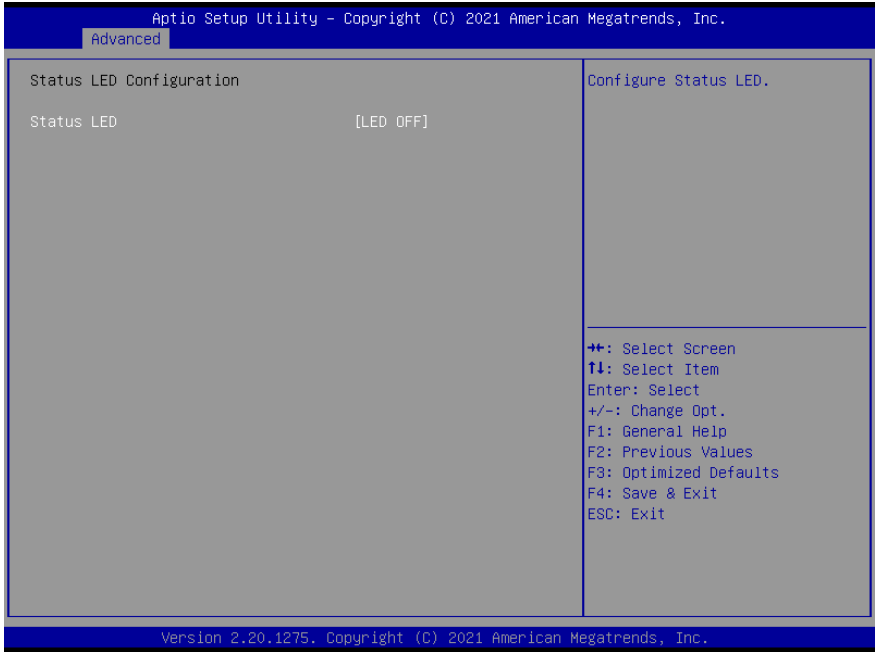

Options Summary		
Status LED	LED OFF	Optimal Default, Failsafe Default
	Red LED on	
	Red LED Blink	
	Red LED fast blink	
	Green LED on	
	Green LED blink	
	Green LED fast blink	
Configure Status LED.		

3.4.10 Network Stack Configuration

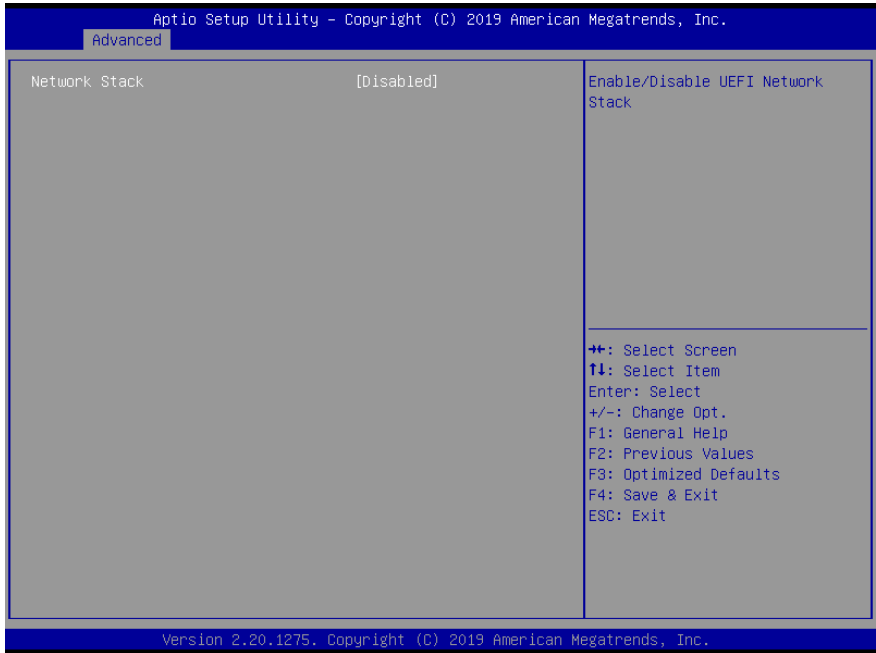

3.4.10.1 Network Stack Configuration (Enabled)

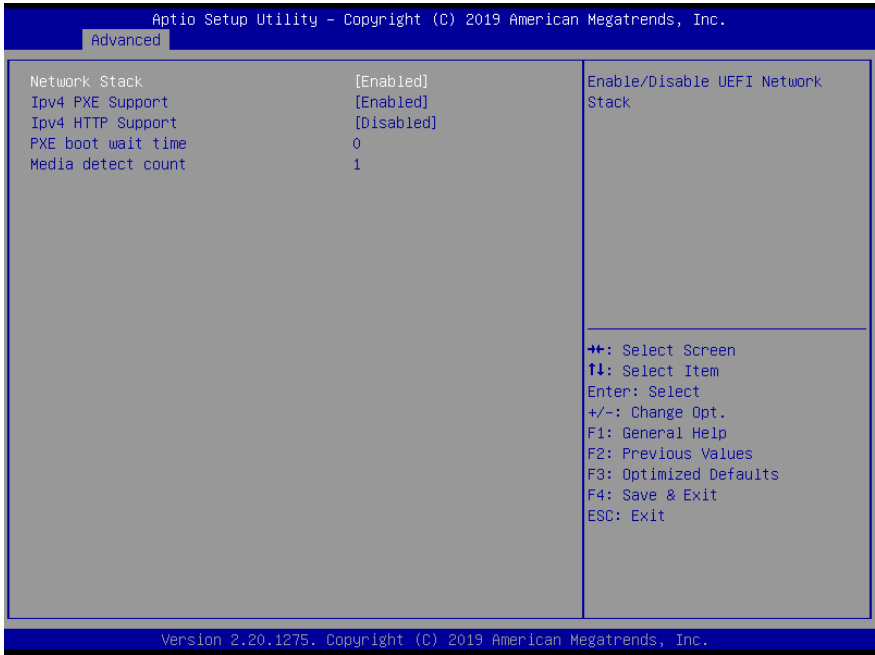

Options Summary		
Network Stack	Disabled	Optimal Default, Failsafe Default
	Enabled	
Enable/Disable UEFI Network Stack		
IPv4 PXE Support	Disabled	Optimal Default, Failsafe Default
	Enabled	
Enable/Disable IPv4 PXE boot support. If disabled, IPv4 PXE boot support will not be available.		
IPv4 HTTP Support	Disabled	Optimal Default, Failsafe Default
	Enabled	
Enable/Disable IPv4 HTTP boot support. If disabled, IPv4 HTTP boot support will not be available.		
PXE boot wait time	0	Optimal Default, Failsafe Default
Wait time in seconds to press ESC key to abort the PXE boot. Use either +/- or numeric keys to set the value.		

Options Summary		
Media detect count	1	Optimal Default, Failsafe Default
Number of times the presence of media will be checked. Use either +/- or numeric keys to set the value.		

3.5 Setup Submenu: Chipset

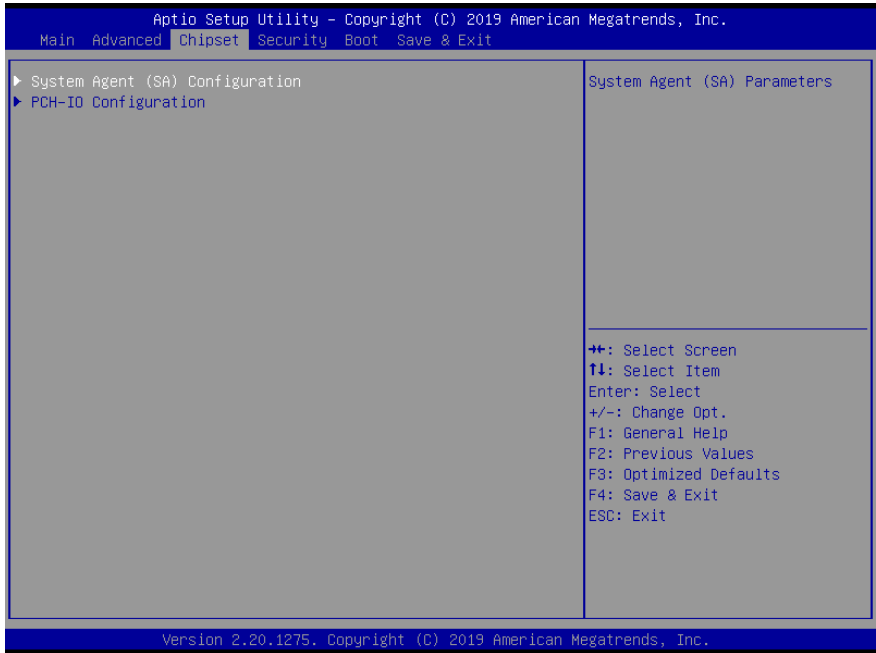

3.5.1 System Agent (SA) Configuration

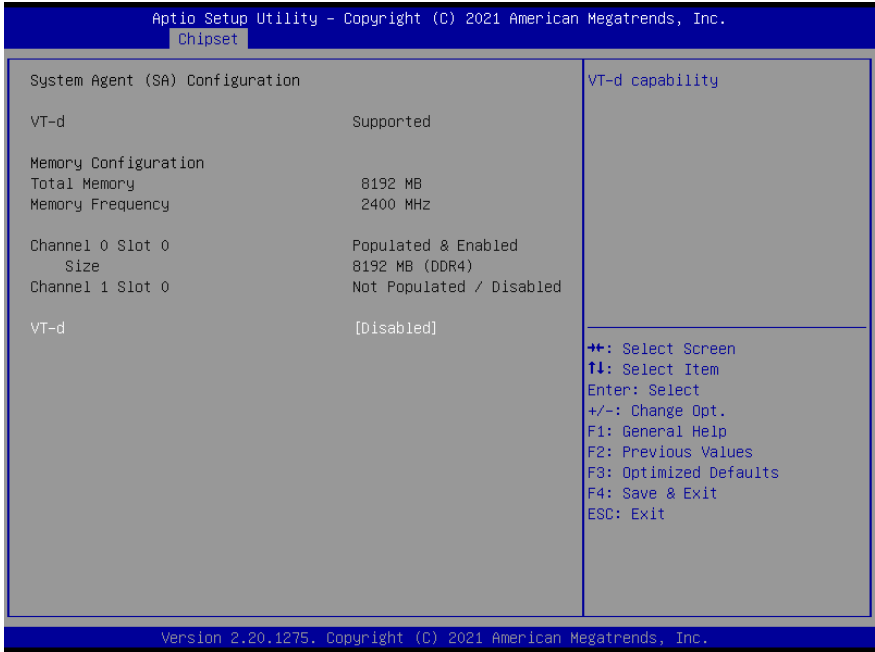

Options Summary		
VT-d	Enabled	Optimal Default, Failsafe Default
	Disabled	
VT-d capability.		

3.5.2 PCH-IO Configuration

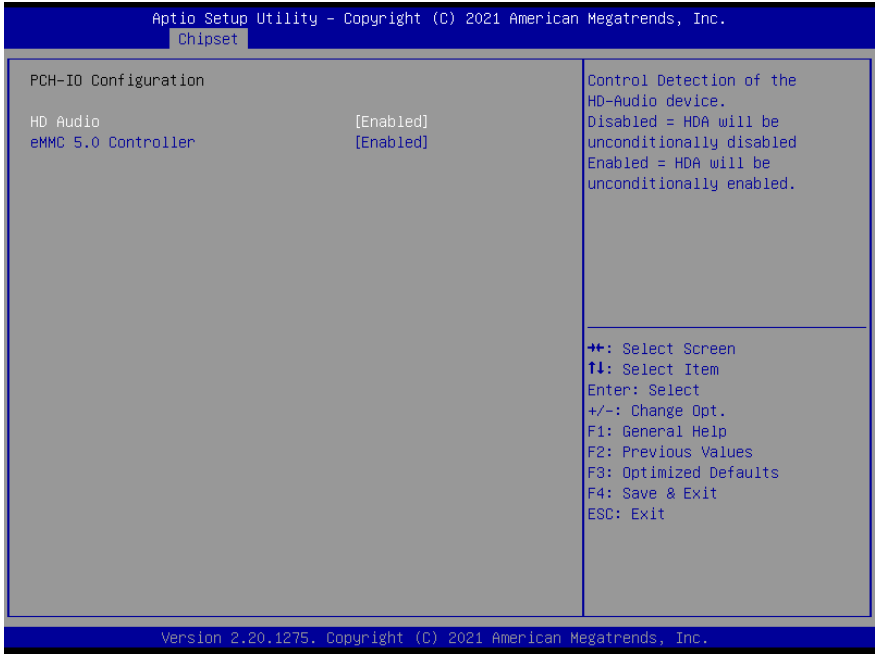

Options Summary		
HD Audio	Enabled	Optimal Default, Failsafe Default
	Disabled	
Control the Detection of the Audio device. Disabled = HDA will be unconditionally disabled. Enabled = HDA will be unconditionally enabled.		
eMMC 5.0 Controller	Enabled	Optimal Default, Failsafe Default
	Disabled	
Enable or disable SCS eMMC 5.0 Controller		

3.6 Setup Submenu: Security

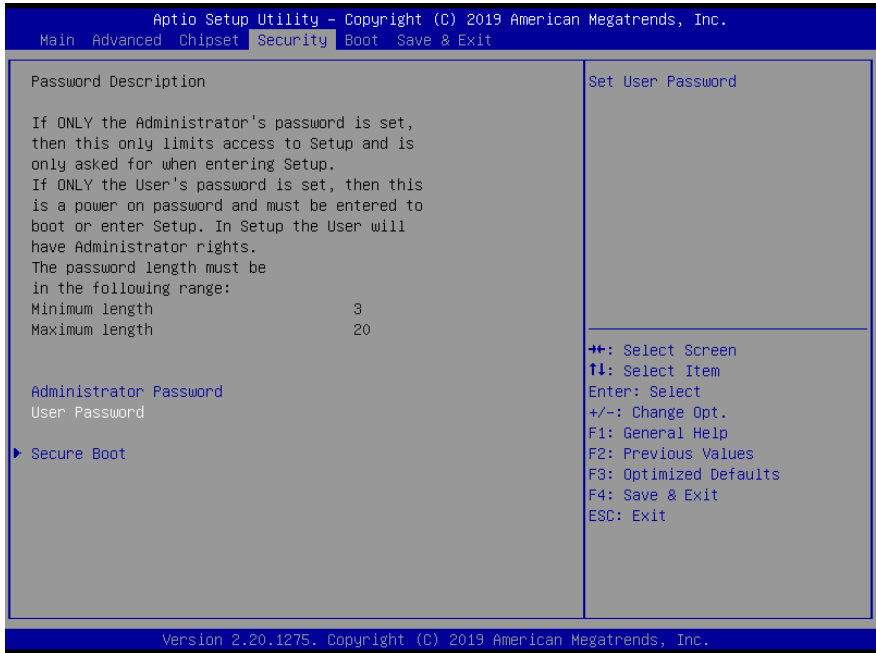

Change User/Administrator Password

You can set an Administrator Password or User Password. An Administrator Password must be set before you can set a User Password. The password will be required during boot up, or when the user enters the Setup utility. A User Password does not provide access to many of the features in the Setup utility.

Select the password you wish to set, and press Enter. In the dialog box, enter your password (must be between 3 and 20 letters or numbers). Press Enter and retype your password to confirm. Press Enter again to set the password.

Removing the Password

Select the password you want to remove and enter the current password. At the next dialog box press Enter to disable password protection.

3.6.1 Secure Boot

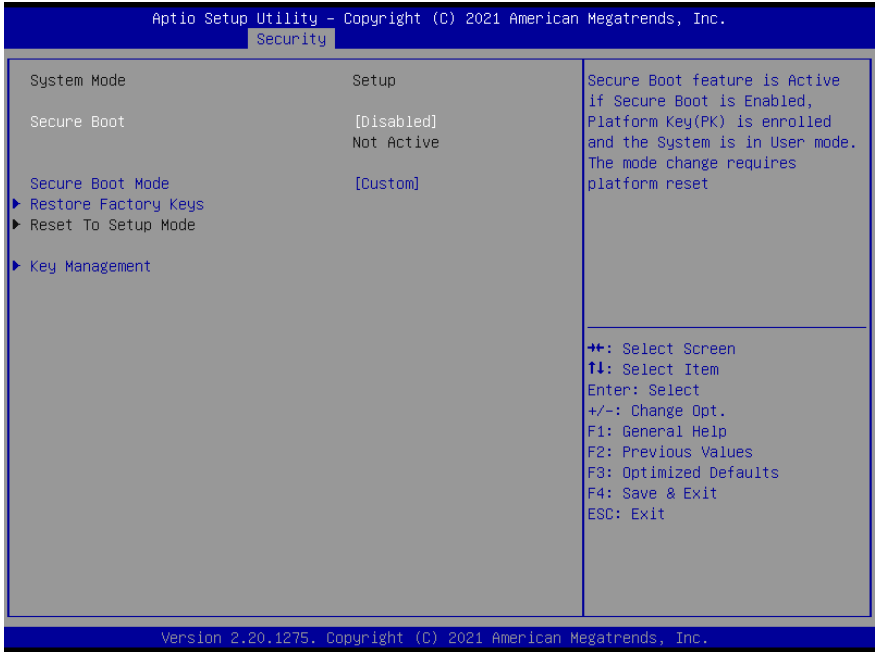

Options Summary		
Secure Boot	Disable	Optimal Default, Failsafe Default
	Enable	
Secure Boot feature is Active if Secure Boot is Enabled, Platform Key (PK) is enrolled and the System mode is in User mode. The mode change requires platform reset.		
Secure Boot Mode	Standard	Optimal Default, Failsafe Default
	Custom	
Secure Boot Mode options: Standard or Custom. In Custom mode, Secure Boot Policy variables can be configured by a physically present user without full authentication.		
Restore Factory Keys	No	Press 'Yes' to restore factory keys
	Yes	
Force System to User Mode. Install factory default Secure Boot key databases		

Options Summary		
Key Management		
Enables expert users to modify Secure Boot Policy variables without full authentication		

3.6.2 Key Management

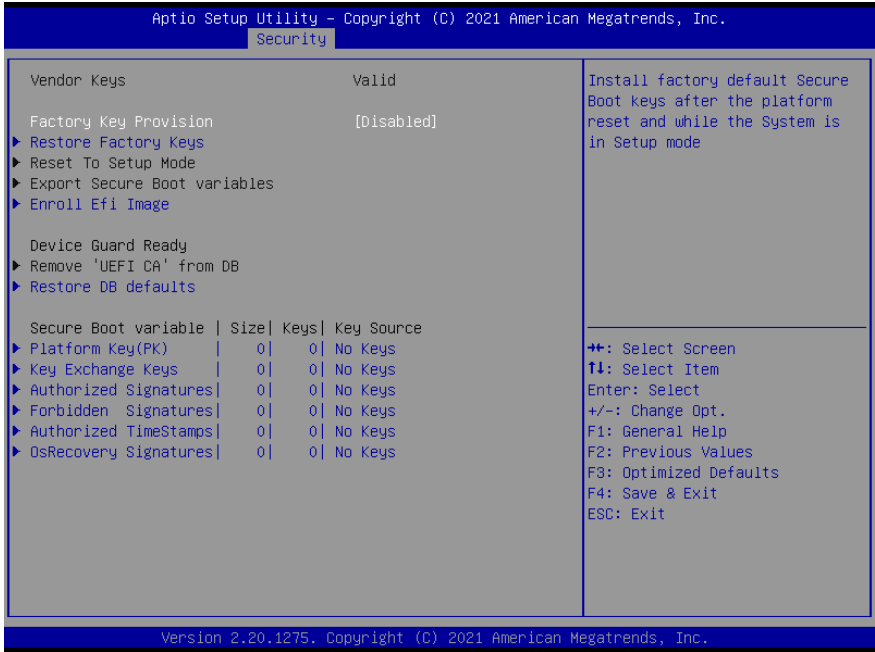

Options Summary		
Factory Key Provision	Disabled	Optimal Default, Failsafe Default
	Enabled	
Install factory default Secure Boot keys after the platform reset and while the System is in Setup mode.		
Restore Factory Keys	No	Press 'Yes' to install factory default keys
	Yes	
Force System to User Mode. Install Factory default Secure Boot key databases.		
Reset To Setup Mode	No	Deleting all variables will reset the System to Setup Mode.
	Yes	
Delete all Secure Boot key databases from NVRAM.		
Exported Secure Boot variables		
Copy NVRAM content of Secure Boot variables to files in a root folder on a file system device.		

Options Summary		
Enroll Efi Image		
Allow the image to run in Secure Boot mode. Enroll SHA256 Hash Certificate of a PE Image into Authorized Signature Database (db).		
Device Guard Ready		
Remove 'UEFI CA' from SB	No	Press 'Yes' to remove 'UEFI CA' From SB
	Yes	
Device Guard ready system must not list 'Microsoft UEFI CA' Certificate in Authorized Signature database(db).		
Restore DB defaults	No	Press 'Yes' to Restore DB defaults
	Yes	
Restore DB variable to factory defaults.		
Secure Boot variable Size Keys# Key Source		
Platform key (PK) 0 0 No Key	Update	Enroll Factory Defaults or load certificates from a file: 1.Public key Certificate: a) EFI_SIGNATURE_LIST b) EFI_CERT_X509 (DER) c) EFI_CERT_RSA2048 (bin) d) EFI_CERT_SHAXXX 2.Authenticated UEFI Variable 3.EFI PE/COFF Image(SHA256) Key Source: Factory, External, Mixed
Key Exchange keys 0 0 No Key	Update Append	Enroll Factory Defaults or load certificates from a file: 1.Public key Certificate: a)EFI_SIGNATURE_LIST b)EFI_CERT_X509 (DER) c)EFI_CERT_RSA2048 (bin) d)EFI_CERT_SHAXXX 2.Authenticated UEFI Variable 3.EFI PE/COFF Image(SHA256) Key Source: Factory, External, Mixed

Table Continues on Next Page...

Options Summary		
Authorized Signatures 0 0 No Key	Update	Enroll Factory Defaults or load certificates from a file: 1.Public key Certificate: a)EFI_SIGNATURE_LIST b)EFI_CERT_X509 (DER) c)EFI_CERT_RSA2048 (bin) d)EFI_CERT_SHAXXX 2.Authenticated UEFI Variable 3.EFI PE/COFF Image(SHA256) Key Source: Factory, External, Mixed
	Append	
Forbidden Signatures 0 0 No Key	Update	Enroll Factory Defaults or load certificates from a file: 1.Public key Certificate: a)EFI_SIGNATURE_LIST b)EFI_CERT_X509 (DER) c)EFI_CERT_RSA2048 (bin) d)EFI_CERT_SHAXXX 2.Authenticated UEFI Variable 3.EFI PE/COFF Image(SHA256) Key Source: Factory, External, Mixed
	Append	
Authorized TimeStamps 0 0 No Key	Update	Enroll Factory Defaults or load certificates from a file: 1.Public key Certificate: a)EFI_SIGNATURE_LIST b)EFI_CERT_X509 (DER) c)EFI_CERT_RSA2048 (bin) d)EFI_CERT_SHAXXX 2.Authenticated UEFI Variable 3.EFI PE/COFF Image(SHA256) Key Source: Factory, External, Mixed
	Append	

Table Continues on Next Page...

Options Summary		
OsRecovery Signatures 0 0 No Key	Update	Enroll Factory Defaults or load certificates from a file: 1.Public key Certificate: a)EFI_SIGNATURE_LIST b)EFI_CERT_X509 (DER) c)EFI_CERT_RSA2048 (bin) d)EFI_CERT_SHAXXX 2.Authenticated UEFI Variable 3.EFI PE/COFF Image(SHA256) Key Source: Factory, External, Mixed
	Append	

3.7 Setup Submenu: Boot

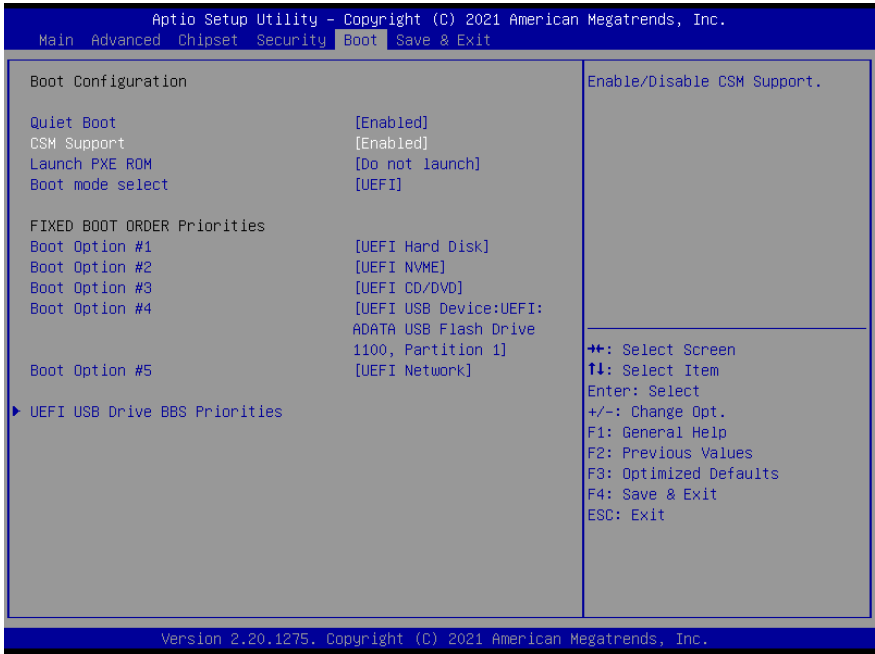

Options Summary		
Quiet Boot	Disabled	Optimal Default, Failsafe Default
	Enabled	
Enables or disables Quiet Boot option.		
CSM Support	Enabled	Optimal Default, Failsafe Default
	Disabled	
Enable/Disable CSM Support.		
Launch PXE ROM	Do not launch	Optimal Default, Failsafe Default
	UEFI	
	Legacy	
Controls the execution of UEFI and Legacy Network OpROM. Note: Network Stack should be enabled if select UEFI PXE Boot.		
Boot mode select	Legacy	Optimal Default, Failsafe Default
	UEFI	
	Dual	
Select boot mode Legacy/UEFI		

3.8 Setup Submenu: Save & Exit

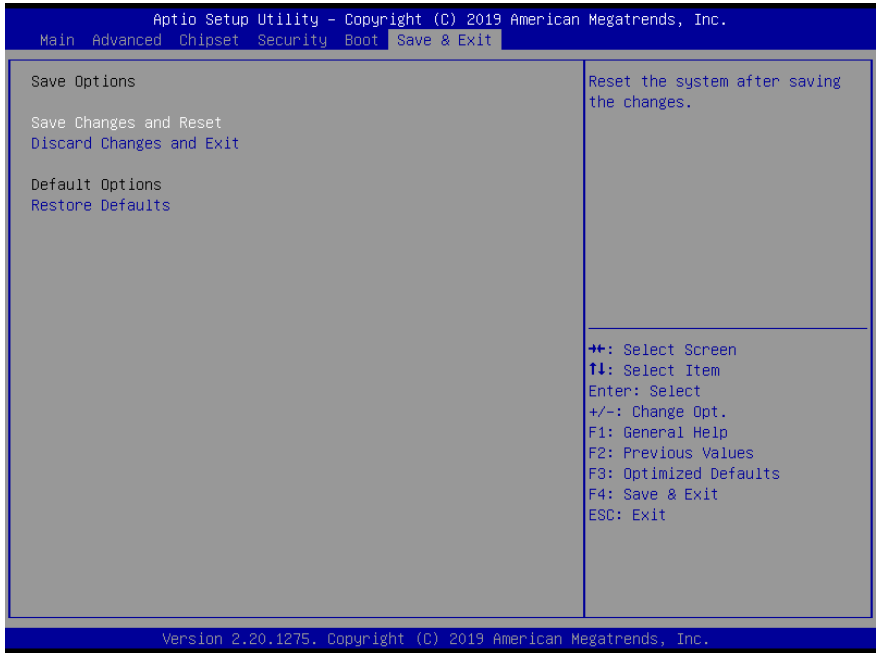

Chapter 4

Drivers Installation

4.1 Driver Download and Installation

Drivers for the VPC-5620S can be downloaded from the product page on the AAEMON website by following this link:

<https://www.aaeon.com/en/p/network-video-recorder-mobile-nvr-vpc-5620s>

Download the driver(s) you need and follow the steps below to install them.

Step 1 – Install Chipset Drivers

1. Open the **Chipset** folder and run **SetupChipset.exe**
2. Follow the instructions
3. Drivers will be installed automatically

Step 2 – Install Graphics Driver

1. Open the **Graphics** folder and run **igxpin.exe**
2. Follow the instructions
3. Drivers will be installed automatically

Step 3 – Install ME & TXE Driver

1. Open the **ME** folder and run **MEISetup.exe**
2. Follow the instructions
3. Drivers will be installed automatically

Step 4 – Install LAN Drivers

1. Open the **LAN** folder and select your OS
2. For Linux, install file from terminal
3. For Windows, run **PROWinx64_25.2.exe**
4. Follow the instructions
5. Drivers will be installed automatically

Step 5 – Install Audio Driver

1. Open the **Audio** folder and run **0008-64bit_Win7_Win8_Win81_Win10_R281.exe**
2. Follow the instructions
3. Drivers will be installed automatically

Chapter 5

SDK Guide

5.1 Introduction

This section details some of the features of the AAEON SDK available for your VPC-5620S system including Gyro, Smart PoE, MCU and CAN AP functions. If you have any questions or need assistance, contact an AAEON representative by visiting our support page.

5.2 CAN Bus

5.2.1 CAN Bus Utility

This section details how to use the AAEON CAN Bus Utility application.

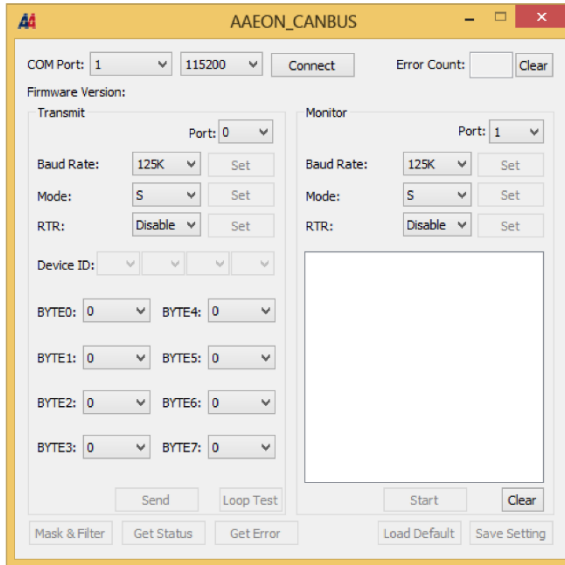

CAN Bus Utility Screenshot

Utility Function Description:

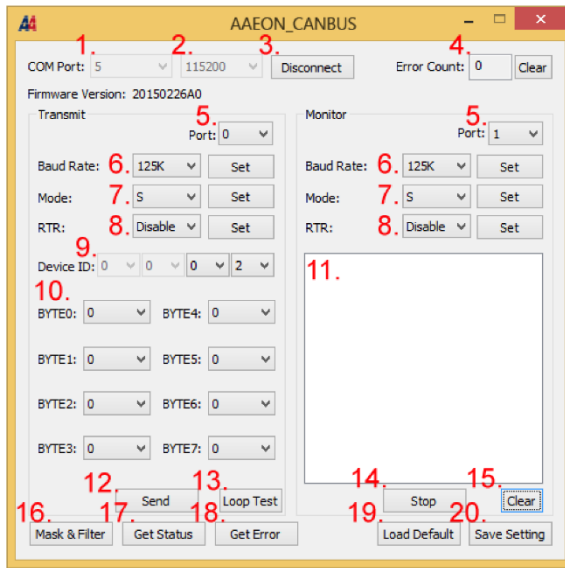

1. COM Port number
2. COM Port baud rate. This can be set to the following:

115200
57600
38400
19200
9600
3. Connect/Disconnect button
4. When doing a loop test, if an error occurs, counter will increase by 1. Clear button will reset error count.
5. CAN bus port selector: 0 or 1

6. CAN bus baud rate. Press set button to apply changes. Baud rate can be set to:

125K
500K
1M

7. CAN bus mode: Standard or Extend mode. Press set button to apply change.

Mode	ID Range
Standard Mode	0x000~0x7FF
Extend Mode	0x00000000~0x1FFFFFFF

8. Enable or disable RTR mode. Press set button to apply change.

If RTR is enabled, a remote frame will be transmitted via the bus. This means that no data bytes are included within this frame. It is necessary to specify the correct data length code which depends on the corresponding data frame with the same identifier coding. If the RTR is not enabled, a data frame will be sent including the number of data bytes as specified by the data length code.

9. CAN bus ID: The identifier is transmitted on the bus first during the arbitration process. The identifier acts as the message name.

10. Data Field: Data to be transmitted.
11. Received data will be listed here
12. Send button, send the data set in Data Field
13. Loop Test function: Sends data automatically.
14. Receive button: Press to start receiving data.
15. Clear receive field
16. Mask and Filter; opens Mask and Filter menu (detailed on next page).
17. Get status from firmware register
18. Get error status from firmware register
19. Load Default settings
20. Save current settings to firmware register

Mask and Filter Menu

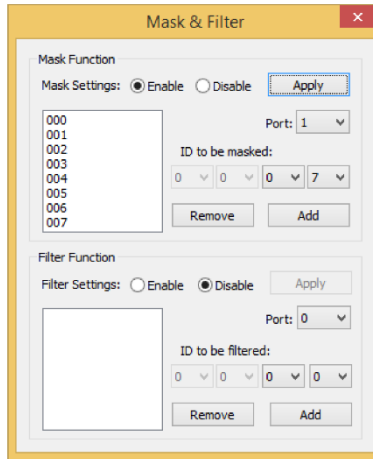

Mask and Filter functions limit which IDs can be received by receiving port.

Mask Function: Specified ID cannot be received.

Filter Function: Only specified ID can be received.

5.2.2 CAN Bus SDK

This section details the command inputs to access various settings and functions of the CAN Bus SDK.

For System Error Codes please refer to the Microsoft support page:

<https://msdn.microsoft.com/zh-tw/library/windows/desktop/ms681381.aspx>

Open an SDK Handle

```
AAEON_API HANDLE aaeonCANOpen(BYTE bComNum, BYTE bComRate);
```

Input	Definition	Variables	Setting
bComNum	COM Port Number		
bComRate	COM Port Baud Rate	0x00	115200
		0x01	57600
		0x02	38400
		0x03	19200
		0x04	9600

Return:

If successful, return a **Handle**

If failed, return **NULL**

Close Handle

AAEON_API BOOL aaeonCANClose(HANDLE hCom);

Input	Definition	Variables	Setting
hCom	A handle opened by aaeonCANOpen		

Return:

TRUE or FALSE

Get Firmware Version

AAEON_API HRESULT aaeonCANGetFirmwareVersion(HANDLE hCom, TCHAR* sVersion);

Input	Definition	Variables	Setting
hCom	A handle opened by aaeonCANOpen		
sVersion	Pointer of parameter		

Return:

S_OK if success, otherwise failed

sVersion: string of firmware version

Set CAN bus Baud Rate

AAEON_API HRESULT aaeonCANSetBaudRate(HANDLE **hCom**, BYTE **bPort**, BYTE **bBaudRate**);

Input	Definition	Variables	Setting
hCom	A handle opened by aaeonCANOpen		
bPort	CAN bus Port Number	0 or 1	
bBaudRate	CAN bus baud rate	0x00	125K
		0x01	500K
		0x02	1M

Return:

S_OK if success, otherwise failed

Set CAN bus Mode

AAEON_API HRESULT aaeonCANSetMode(HANDLE **hCom**, BYTE **bPort**, BYTE **bMode**);

Input	Definition	Variables	Setting
hCom	A handle opened by aaeonCANOpen		
bPort	CAN bus Port Number	0 or 1	
bMode	CAN bus mode	0x00	Standard Mode
		0x01	Extend Mode

Return:

S_OK if success, otherwise failed

Set RTR Mode

AAEON_API HRESULT aaeonCANSetRTREnable(HANDLE **hCom**, BYTE **bPort**, BOOL **bEnable**);

Input	Definition	Variables	Setting
hCom	A handle opened by aaeonCANOpen		
bPort	CAN bus Port Number	0 or 1	
bEnable	Turn On or Off		

Return:

S_OK if success, otherwise failed

Set Mask Function Enable

AAEON_API HRESULT aaeonCANSetMaskEnable(HANDLE **hCom**, BYTE **bPort**, BOOL **bEnable**);

Input	Definition	Variables	Setting
hCom	A handle opened by aaeonCANOpen		
bPort	CAN bus Port Number	0 or 1	
bEnable	Turn On or Off		

Return:

S_OK if success, otherwise failed

Mask CAN bus ID

AAEON_API HRESULT aaeonCANSetMask(HANDLE **hCom**, BYTE **bPort**, DWORD **dwDevID**, BYTE **bBlock**, BOOL **bEnable**);

Input	Definition	Variables	Setting
hCom	A handle opened by aaeonCANOpen		
bPort	CAN bus Port Number	0 or 1	
dwDevID	ID to be masked.ID range depends on CAN bus mode.		
bBlock	Add to which mask block	0~7	
bEnable	Turn On or Off	TRUE	Add masked ID
		FALSE	Delete selected ID

Return:

S_OK if success, otherwise failed

Set Filter Function Enable

AAEON_API HRESULT aaeonCANSetFilterEnable(HANDLE **hCom**, BYTE **bPort**, BOOL **bEnable**);

Input	Definition	Variables	Setting
hCom	A handle opened by aaeonCANOpen		
bPort	CAN bus Port Number	0 or 1	
bEnable	Turn On or Off		

Return:

S_OK if success, otherwise failed

Filter CAN Bus ID

AAEON_API HRESULT aaeonCANSetFilter(HANDLE **hCom**, BYTE **bPort**, DWORD **dwDevID**, BYTE **bBlock**, BOOL **bEnable**);

Input	Definition	Variables	Setting
hCom	A handle opened by aaeonCANOpen		
bPort	CAN bus Port Number	0 or 1	
dwDevID	ID to be masked.ID range depends on CAN bus mode.		
bBlock	Add to which mask block	0~7	
bEnable	Turn On or Off	TRUE	Add masked ID
		FALSE	Delete selected ID

Return:

S_OK if success, otherwise failed

Get Error Status from Firmware Register

AAEON_API HRESULT aaeonCANGetError(HANDLE **hCom**, BYTE **bPort**, MSG_T* **inbuf**);

Input	Definition	Variables	Setting
hCom	A handle opened by aaeonCANOpen		
bPort	CAN bus Port Number	0 or 1	
inbuf	Pointer of parameter		

Return:

S_OK if success, otherwise failed

inbuf: Data of error status

Get Status from Firmware Register

```
AAEON_API HRESULT aaeonCANGetStatus(HANDLE hCom, BYTE bPort, BYTE
bStatPage, char* caData);
```

Input	Definition	Variables	Setting
hCom	A handle opened by aaeonCANOpen		
bPort	CAN bus Port Number	0 or 1	
bStatPage	Which status page		

Return:

S_OK if success, otherwise failed

inbuf: Data of error status

Send Data via CAN Bus

```
AAEON_API HRESULT aaeonCANTransmitData(HANDLE hCom, BYTE bPort, MSG_T
msgData);
```

Input	Definition	Variables	Setting
hCom	A handle opened by aaeonCANOpen		
bPort	CAN bus Port Number	0 or 1	
msgData	Data to be sent		

Return:

S_OK if success, otherwise failed

Receive Data via CAN Bus

```
AAEON_API HRESULT aaeonCANReceiveData(HANDLE hCom, BYTE bPort, MSG_T*
inbuf);
```

Input	Definition	Variables	Setting
hCom	A handle opened by aaeonCANOpen		
bPort	CAN bus Port Number	0 or 1	
inbuf	Pointer of parameter		

Return:

S_OK if success, otherwise failed

inbuf: Received data

Save Current Setting to Firmware Register

```
AAEON_API HRESULT aaeonCANSaveSetting(HANDLE hCom);
```

Input	Definition	Variables	Setting
hCom	A handle opened by aaeonCANOpen		

Return:

S_OK if success, otherwise failed

Load Default Setting from Firmware Register

AAEON_API HRESULT aaeonCANLoadDefault(HANDLE hCom);

Input	Definition	Variables	Setting
hCom	A handle opened by aaeonCANOpen		

Return:

S_OK if success, otherwise failed

5.3 Accelerometer & Gyroscope Utility

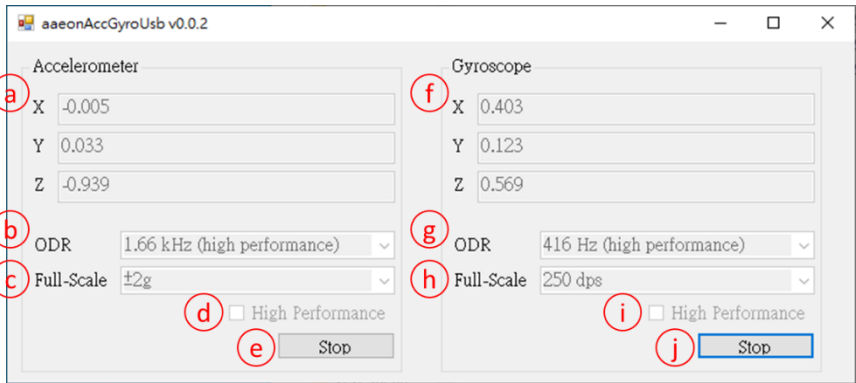

- a. Current G values for the X, Y, and Z axes of the accelerometer
- b. Output Data Rate setting for accelerometer. Options in the following table:

High Performance Disabled	High Performance Enabled
1.6 Hz (low power only)	12.5 Hz (high performance)
12.5 Hz (low power)	12.5 Hz (high performance)
26 Hz (low power)	26 Hz (high performance)
52 Hz (low power)	52 Hz (high performance)
104 Hz (normal mode)	104 Hz (high performance)
208 Hz (normal mode)	208 Hz (high performance)
416 Hz (high performance)	416 Hz (high performance)
833 Hz (high performance)	833 Hz (high performance)
1.66 kHz (high performance)	1.66 kHz (high performance)
3.33 kHz (high performance)	3.33 kHz (high performance)
6.66 kHz (high performance)	6.66 kHz (high performance)

- c. Accelerometer Full-Scale setting; options are $\pm 2g$, $\pm 4g$, $\pm 8g$, $\pm 16g$
- d. Enable/Disable accelerometer High Performance mode.
- e. Start/Stop accelerometer monitor.

- f. Current angular velocity values for the X, Y, and Z axes of the gyroscope measured in degrees per second (dps).
- g. Output Data Rate setting for gyroscope. Options in the following table:

High Performance Disabled	High Performance Enabled
12.5 Hz (low power)	12.5 Hz (high performance)
26 Hz (low power)	26 Hz (high performance)
52 Hz (low power)	52 Hz (high performance)
104 Hz (normal mode)	104 Hz (high performance)
208 Hz (normal mode)	208 Hz (high performance)
416 Hz (high performance)	416 Hz (high performance)
833 Hz (high performance)	833 Hz (high performance)
1.66 kHz (high performance)	1.66 kHz (high performance)
3.33 kHz (high performance)	3.33 kHz (high performance)
6.66 kHz (high performance)	6.66 kHz (high performance)

- h. Gyroscope Full-Scale setting; options are 250, 500, 1000, or 2000 dps.
- i. Enable/Disable gyroscope High Performance mode.
- j. Start/Stop gyroscope monitor.

5.4 Power MCU Utility

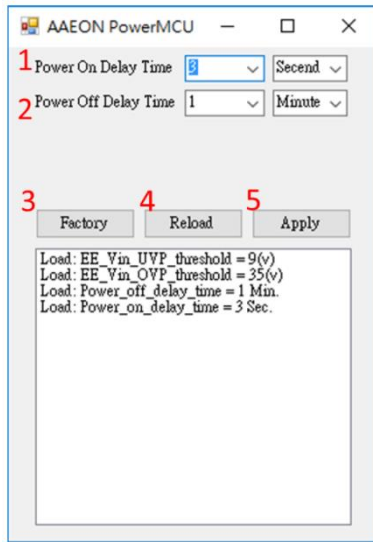

1. Power On Delay Time, default is 5 seconds.
2. Power Off Delay Time, default is 1 minute.
3. Factory button, click to erase EEPROM
4. Reload button, click to reload MCU settings
5. Apply button, click to write settings to MCU

5.5 Smart PoE Utility

5.5.1 About Smart PoE

AAEON Smart PoE application supports monitoring the current and voltage of each PoE port in parallel, as well as the temperature of the PoE controller (IC TSP23861). AAEON Smart PoE offers advanced thermal protection which cuts source power when the temperature of the PoE controller exceeds 154°C, turning PoE mode to OFF status. AAEON Smart PoE provides users with three monitoring modes: Auto, Semi-Auto, and Manual.

Auto

PoE Controller will determine priority to implement Detect, Classification, Power On/Off and Exception Handling.

Semi-Auto

PoE Controller will provide Detection and Classification. Power status is controlled by user.

Manual

User can force booting power without the controller providing Detection and Classification. User can manually power on/off each port as well as adjust wattage and monitor the PoE controller temperature.

The user can define the power consumption of each PoE port in steps of 6, 11, 19, or 31 Watts under Semi-Auto and Manual mode to protect the device. If power consumption exceeds the settings, the Smart PoE will throttle power to that port.

The VPC-5620S is designed to deliver 60 Watts of power per every four PoE ports. The power budget is a total constraint which cannot be exceeded in the settings. For

example, if the power consumption of Ports 1 and 2 total 50 Watts, the setting for Port 3 cannot be higher than 6 Watts.

5.5.2 Smart PoE Utility Description

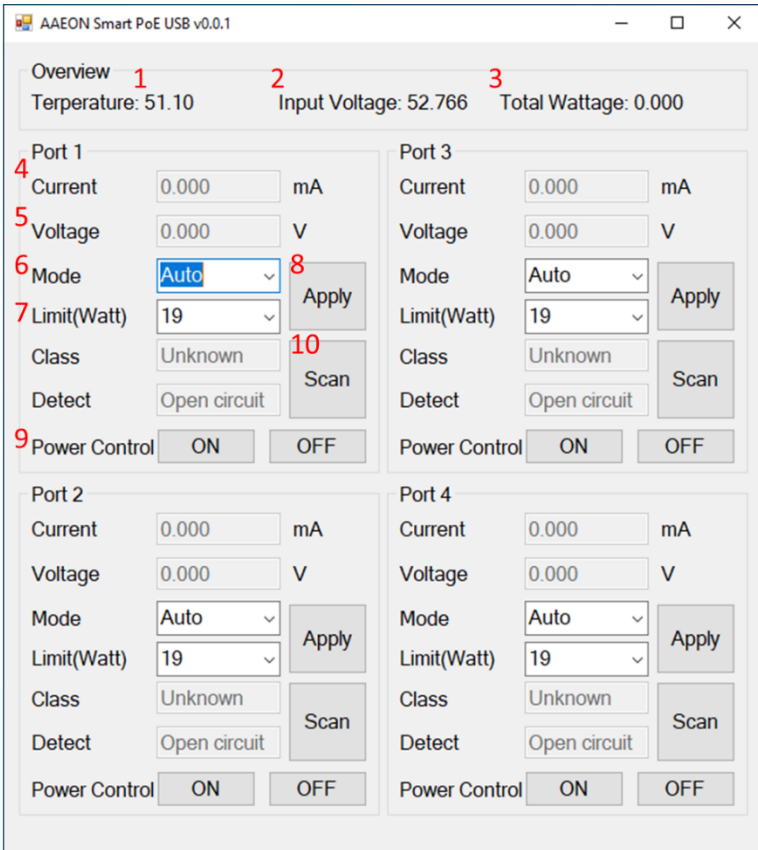

1. PoE Controller Temperature
2. PoE Adapter Input Voltage
3. Total Wattage of the four PoE ports
4. Port total current in milliamps
5. Port total voltage in Volts
6. Port PoE Mode: Auto, Semi-Auto, Manual
7. Port Wattage Limit; can be set in Semi-Auto and Manual modes
8. Apply settings to PoE Port
9. Power On/Off PoE Port
10. Scan; rescan to provide classification and detection of connected devices.

5.6 DIO Utility



1. DIO value. If set to input mode, it will pull high (display bright green). If set to output mode, user can set the value by clicking the square.
2. DIO mode. Click the button to change DIO mode between Input and Output.

5.7 Watchdog SDK

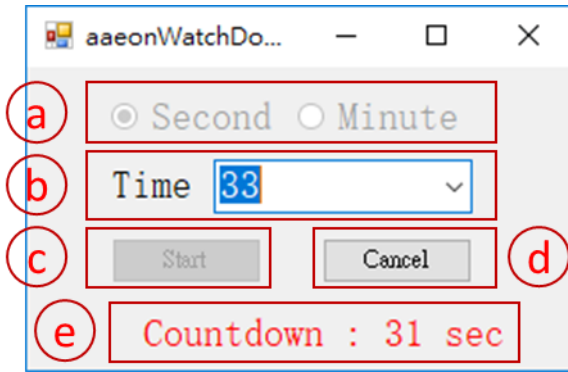



























































- a. Select unit of time, either Seconds or Minutes
- b. Time interval for Watchdog Timer
- c. Start Watchdog
- d. Cancel Watchdog
- e. Time left before Watchdog event

Appendix A











































I/O Information











































A.1 I/O Address Map











































	[0000000000000000 - 000000000000CF7]	PCI Express Root Complex
	[0000000000000020 - 000000000000021]	Programmable interrupt controller
	[0000000000000024 - 000000000000025]	Programmable interrupt controller
	[0000000000000028 - 000000000000029]	Programmable interrupt controller
	[000000000000002C - 00000000000002D]	Programmable interrupt controller
	[000000000000002E - 00000000000002F]	Motherboard resources
	[0000000000000030 - 000000000000031]	Programmable interrupt controller
	[0000000000000034 - 000000000000035]	Programmable interrupt controller
	[0000000000000038 - 000000000000039]	Programmable interrupt controller
	[000000000000003C - 00000000000003D]	Programmable interrupt controller
	[0000000000000040 - 000000000000043]	System timer
	[000000000000004E - 00000000000004F]	Motherboard resources
	[0000000000000050 - 000000000000053]	System timer
	[0000000000000061 - 000000000000061]	Motherboard resources
	[0000000000000063 - 000000000000063]	Motherboard resources
	[0000000000000065 - 000000000000065]	Motherboard resources
	[0000000000000067 - 000000000000067]	Motherboard resources
	[0000000000000070 - 000000000000070]	Motherboard resources
	[0000000000000080 - 000000000000080]	Motherboard resources
	[0000000000000092 - 000000000000092]	Motherboard resources
	[00000000000000A0 - 00000000000000A1]	Programmable interrupt controller
	[00000000000000A4 - 00000000000000A5]	Programmable interrupt controller
	[00000000000000A8 - 00000000000000A9]	Programmable interrupt controller
	[00000000000000AC - 00000000000000AD]	Programmable interrupt controller
	[00000000000000B0 - 00000000000000B1]	Programmable interrupt controller
	[00000000000000B2 - 00000000000000B3]	Motherboard resources
	[00000000000000B4 - 00000000000000B5]	Programmable interrupt controller
	[00000000000000B8 - 00000000000000B9]	Programmable interrupt controller
	[00000000000000BC - 00000000000000BD]	Programmable interrupt controller
	[00000000000002C0 - 00000000000002C7]	Communications Port (COM6)
	[00000000000002D0 - 00000000000002D7]	Communications Port (COM5)
	[00000000000002E8 - 00000000000002EF]	Communications Port (COM4)
	[00000000000002F8 - 00000000000002FF]	Communications Port (COM2)
	[00000000000003E8 - 00000000000003EF]	Communications Port (COM3)
	[00000000000003F8 - 00000000000003FF]	Communications Port (COM1)
	[00000000000004D0 - 00000000000004D1]	Programmable interrupt controller
	[0000000000000680 - 000000000000069F]	Motherboard resources
	[0000000000000A00 - 0000000000000A0F]	Motherboard resources
	[0000000000000A10 - 0000000000000A1F]	Motherboard resources
	[0000000000000A20 - 0000000000000A2F]	Motherboard resources
	[0000000000000D00 - 000000000000FFFF]	PCI Express Root Complex











































	[000000000000D00 - 000000000000FFF]	PCI Express Root Complex
	[000000000000164E - 000000000000164F]	Motherboard resources
	[0000000000001800 - 00000000000018FE]	Motherboard resources
	[0000000000001854 - 0000000000001857]	Motherboard resources
	[0000000000002000 - 00000000000020FE]	Motherboard resources
	[0000000000003000 - 0000000000003FFF]	Intel(R) PCI Express Root Port #10 - 9DB1
	[0000000000004000 - 0000000000004FFF]	Intel(R) PCI Express Root Port #8 - 9DBF
	[0000000000005000 - 0000000000005FFF]	Intel(R) PCI Express Root Port #7 - 9DBE
	[0000000000006000 - 0000000000006FFF]	Intel(R) PCI Express Root Port #6 - 9DBD
	[0000000000007000 - 0000000000007FFF]	Intel(R) PCI Express Root Port #5 - 9DBC
	[0000000000007000 - 0000000000007FFF]	PCI Express Downstream Switch Port
	[0000000000007000 - 0000000000007FFF]	PCI Express Upstream Switch Port
	[0000000000008000 - 000000000000803F]	Intel(R) UHD Graphics 620
	[0000000000008060 - 000000000000807F]	Standard SATA AHCI Controller
	[0000000000008080 - 0000000000008083]	Standard SATA AHCI Controller
	[0000000000008090 - 0000000000008097]	Standard SATA AHCI Controller
	[000000000000EFA0 - 000000000000EFBF]	Intel(R) SMBus - 9DA3











































A.2 IRQ Mapping Chart











































	(ISA) 0x00000000 (00)	System timer
	(ISA) 0x00000003 (03)	Communications Port (COM2)
	(ISA) 0x00000004 (04)	Communications Port (COM1)
	(ISA) 0x0000000B (11)	Communications Port (COM3)
	(ISA) 0x0000000B (11)	Communications Port (COM4)
	(ISA) 0x0000000B (11)	Communications Port (COM5)
	(ISA) 0x0000000B (11)	Communications Port (COM6)
	(ISA) 0x0000000E (14)	Intel(R) Serial IO GPIO Host Controller - INT34BB
	(ISA) 0x00000036 (54)	Microsoft ACPI-Compliant System
	(ISA) 0x00000037 (55)	Microsoft ACPI-Compliant System
	(ISA) 0x00000038 (56)	Microsoft ACPI-Compliant System
	(ISA) 0x00000039 (57)	Microsoft ACPI-Compliant System
	(ISA) 0x0000003A (58)	Microsoft ACPI-Compliant System
	(ISA) 0x0000003B (59)	Microsoft ACPI-Compliant System
	(ISA) 0x0000003C (60)	Microsoft ACPI-Compliant System
	(ISA) 0x0000003D (61)	Microsoft ACPI-Compliant System
	(ISA) 0x0000003E (62)	Microsoft ACPI-Compliant System
	(ISA) 0x0000003F (63)	Microsoft ACPI-Compliant System
	(ISA) 0x00000040 (64)	Microsoft ACPI-Compliant System
	(ISA) 0x00000041 (65)	Microsoft ACPI-Compliant System
	(ISA) 0x00000042 (66)	Microsoft ACPI-Compliant System
	(ISA) 0x00000043 (67)	Microsoft ACPI-Compliant System
	(ISA) 0x00000044 (68)	Microsoft ACPI-Compliant System
	(ISA) 0x00000045 (69)	Microsoft ACPI-Compliant System
	(ISA) 0x00000046 (70)	Microsoft ACPI-Compliant System
	(ISA) 0x00000047 (71)	Microsoft ACPI-Compliant System
	(ISA) 0x00000048 (72)	Microsoft ACPI-Compliant System
	(ISA) 0x00000049 (73)	Microsoft ACPI-Compliant System
	(ISA) 0x0000004A (74)	Microsoft ACPI-Compliant System
	(ISA) 0x0000004B (75)	Microsoft ACPI-Compliant System
	(ISA) 0x0000004C (76)	Microsoft ACPI-Compliant System
	(ISA) 0x0000004D (77)	Microsoft ACPI-Compliant System
	(ISA) 0x0000004E (78)	Microsoft ACPI-Compliant System
	(ISA) 0x0000004F (79)	Microsoft ACPI-Compliant System
	(ISA) 0x00000050 (80)	Microsoft ACPI-Compliant System
	(ISA) 0x00000051 (81)	Microsoft ACPI-Compliant System
	(ISA) 0x00000052 (82)	Microsoft ACPI-Compliant System
	(ISA) 0x00000053 (83)	Microsoft ACPI-Compliant System
	(ISA) 0x00000054 (84)	Microsoft ACPI-Compliant System
	(ISA) 0x00000055 (85)	Microsoft ACPI-Compliant System
	(ISA) 0x00000056 (86)	Microsoft ACPI-Compliant System
	(ISA) 0x00000057 (87)	Microsoft ACPI-Compliant System











































 (ISA) 0x00000057 (87)	Microsoft ACPI-Compliant System
 (ISA) 0x00000058 (88)	Microsoft ACPI-Compliant System
 (ISA) 0x00000059 (89)	Microsoft ACPI-Compliant System
 (ISA) 0x0000005A (90)	Microsoft ACPI-Compliant System
 (ISA) 0x0000005B (91)	Microsoft ACPI-Compliant System
 (ISA) 0x0000005C (92)	Microsoft ACPI-Compliant System
 (ISA) 0x0000005D (93)	Microsoft ACPI-Compliant System
 (ISA) 0x0000005E (94)	Microsoft ACPI-Compliant System
 (ISA) 0x0000005F (95)	Microsoft ACPI-Compliant System
 (ISA) 0x00000060 (96)	Microsoft ACPI-Compliant System
 (ISA) 0x00000061 (97)	Microsoft ACPI-Compliant System
 (ISA) 0x00000062 (98)	Microsoft ACPI-Compliant System
 (ISA) 0x00000063 (99)	Microsoft ACPI-Compliant System
 (ISA) 0x00000064 (100)	Microsoft ACPI-Compliant System
 (ISA) 0x00000065 (101)	Microsoft ACPI-Compliant System
 (ISA) 0x00000066 (102)	Microsoft ACPI-Compliant System
 (ISA) 0x00000067 (103)	Microsoft ACPI-Compliant System
 (ISA) 0x00000068 (104)	Microsoft ACPI-Compliant System
 (ISA) 0x00000069 (105)	Microsoft ACPI-Compliant System
 (ISA) 0x0000006A (106)	Microsoft ACPI-Compliant System
 (ISA) 0x0000006B (107)	Microsoft ACPI-Compliant System
 (ISA) 0x0000006C (108)	Microsoft ACPI-Compliant System
 (ISA) 0x0000006D (109)	Microsoft ACPI-Compliant System
 (ISA) 0x0000006E (110)	Microsoft ACPI-Compliant System
 (ISA) 0x0000006F (111)	Microsoft ACPI-Compliant System
 (ISA) 0x00000070 (112)	Microsoft ACPI-Compliant System
 (ISA) 0x00000071 (113)	Microsoft ACPI-Compliant System
 (ISA) 0x00000072 (114)	Microsoft ACPI-Compliant System
 (ISA) 0x00000073 (115)	Microsoft ACPI-Compliant System
 (ISA) 0x00000074 (116)	Microsoft ACPI-Compliant System
 (ISA) 0x00000075 (117)	Microsoft ACPI-Compliant System
 (ISA) 0x00000076 (118)	Microsoft ACPI-Compliant System
 (ISA) 0x00000077 (119)	Microsoft ACPI-Compliant System
 (ISA) 0x00000078 (120)	Microsoft ACPI-Compliant System
 (ISA) 0x00000079 (121)	Microsoft ACPI-Compliant System
 (ISA) 0x0000007A (122)	Microsoft ACPI-Compliant System
 (ISA) 0x0000007B (123)	Microsoft ACPI-Compliant System
 (ISA) 0x0000007C (124)	Microsoft ACPI-Compliant System
 (ISA) 0x0000007D (125)	Microsoft ACPI-Compliant System
 (ISA) 0x0000007E (126)	Microsoft ACPI-Compliant System
 (ISA) 0x0000007F (127)	Microsoft ACPI-Compliant System
 (ISA) 0x00000080 (128)	Microsoft ACPI-Compliant System











































 (ISA) 0x00000080 (128)	Microsoft ACPI-Compliant System
 (ISA) 0x00000081 (129)	Microsoft ACPI-Compliant System
 (ISA) 0x00000082 (130)	Microsoft ACPI-Compliant System
 (ISA) 0x00000083 (131)	Microsoft ACPI-Compliant System
 (ISA) 0x00000084 (132)	Microsoft ACPI-Compliant System
 (ISA) 0x00000085 (133)	Microsoft ACPI-Compliant System
 (ISA) 0x00000086 (134)	Microsoft ACPI-Compliant System
 (ISA) 0x00000087 (135)	Microsoft ACPI-Compliant System
 (ISA) 0x00000088 (136)	Microsoft ACPI-Compliant System
 (ISA) 0x00000089 (137)	Microsoft ACPI-Compliant System
 (ISA) 0x0000008A (138)	Microsoft ACPI-Compliant System
 (ISA) 0x0000008B (139)	Microsoft ACPI-Compliant System
 (ISA) 0x0000008C (140)	Microsoft ACPI-Compliant System
 (ISA) 0x0000008D (141)	Microsoft ACPI-Compliant System
 (ISA) 0x0000008E (142)	Microsoft ACPI-Compliant System
 (ISA) 0x0000008F (143)	Microsoft ACPI-Compliant System
 (ISA) 0x00000090 (144)	Microsoft ACPI-Compliant System
 (ISA) 0x00000091 (145)	Microsoft ACPI-Compliant System
 (ISA) 0x00000092 (146)	Microsoft ACPI-Compliant System
 (ISA) 0x00000093 (147)	Microsoft ACPI-Compliant System
 (ISA) 0x00000094 (148)	Microsoft ACPI-Compliant System
 (ISA) 0x00000095 (149)	Microsoft ACPI-Compliant System
 (ISA) 0x00000096 (150)	Microsoft ACPI-Compliant System
 (ISA) 0x00000097 (151)	Microsoft ACPI-Compliant System
 (ISA) 0x00000098 (152)	Microsoft ACPI-Compliant System
 (ISA) 0x00000099 (153)	Microsoft ACPI-Compliant System
 (ISA) 0x0000009A (154)	Microsoft ACPI-Compliant System
 (ISA) 0x0000009B (155)	Microsoft ACPI-Compliant System
 (ISA) 0x0000009C (156)	Microsoft ACPI-Compliant System
 (ISA) 0x0000009D (157)	Microsoft ACPI-Compliant System
 (ISA) 0x0000009E (158)	Microsoft ACPI-Compliant System
 (ISA) 0x0000009F (159)	Microsoft ACPI-Compliant System
 (ISA) 0x000000A0 (160)	Microsoft ACPI-Compliant System
 (ISA) 0x000000A1 (161)	Microsoft ACPI-Compliant System
 (ISA) 0x000000A2 (162)	Microsoft ACPI-Compliant System
 (ISA) 0x000000A3 (163)	Microsoft ACPI-Compliant System
 (ISA) 0x000000A4 (164)	Microsoft ACPI-Compliant System
 (ISA) 0x000000A5 (165)	Microsoft ACPI-Compliant System
 (ISA) 0x000000A6 (166)	Microsoft ACPI-Compliant System
 (ISA) 0x000000A7 (167)	Microsoft ACPI-Compliant System
 (ISA) 0x000000A8 (168)	Microsoft ACPI-Compliant System
 (ISA) 0x000000A9 (169)	Microsoft ACPI-Compliant System











































 (ISA) 0x000000A9 (169)	Microsoft ACPI-Compliant System
 (ISA) 0x000000AA (170)	Microsoft ACPI-Compliant System
 (ISA) 0x000000AB (171)	Microsoft ACPI-Compliant System
 (ISA) 0x000000AC (172)	Microsoft ACPI-Compliant System
 (ISA) 0x000000AD (173)	Microsoft ACPI-Compliant System
 (ISA) 0x000000AE (174)	Microsoft ACPI-Compliant System
 (ISA) 0x000000AF (175)	Microsoft ACPI-Compliant System
 (ISA) 0x000000B0 (176)	Microsoft ACPI-Compliant System
 (ISA) 0x000000B1 (177)	Microsoft ACPI-Compliant System
 (ISA) 0x000000B2 (178)	Microsoft ACPI-Compliant System
 (ISA) 0x000000B3 (179)	Microsoft ACPI-Compliant System
 (ISA) 0x000000B4 (180)	Microsoft ACPI-Compliant System
 (ISA) 0x000000B5 (181)	Microsoft ACPI-Compliant System
 (ISA) 0x000000B6 (182)	Microsoft ACPI-Compliant System
 (ISA) 0x000000B7 (183)	Microsoft ACPI-Compliant System
 (ISA) 0x000000B8 (184)	Microsoft ACPI-Compliant System
 (ISA) 0x000000B9 (185)	Microsoft ACPI-Compliant System
 (ISA) 0x000000BA (186)	Microsoft ACPI-Compliant System
 (ISA) 0x000000BB (187)	Microsoft ACPI-Compliant System
 (ISA) 0x000000BC (188)	Microsoft ACPI-Compliant System
 (ISA) 0x000000BD (189)	Microsoft ACPI-Compliant System
 (ISA) 0x000000BE (190)	Microsoft ACPI-Compliant System
 (ISA) 0x000000BF (191)	Microsoft ACPI-Compliant System
 (ISA) 0x000000C0 (192)	Microsoft ACPI-Compliant System
 (ISA) 0x000000C1 (193)	Microsoft ACPI-Compliant System
 (ISA) 0x000000C2 (194)	Microsoft ACPI-Compliant System
 (ISA) 0x000000C3 (195)	Microsoft ACPI-Compliant System
 (ISA) 0x000000C4 (196)	Microsoft ACPI-Compliant System
 (ISA) 0x000000C5 (197)	Microsoft ACPI-Compliant System
 (ISA) 0x000000C6 (198)	Microsoft ACPI-Compliant System
 (ISA) 0x000000C7 (199)	Microsoft ACPI-Compliant System
 (ISA) 0x000000C8 (200)	Microsoft ACPI-Compliant System
 (ISA) 0x000000C9 (201)	Microsoft ACPI-Compliant System
 (ISA) 0x000000CA (202)	Microsoft ACPI-Compliant System
 (ISA) 0x000000CB (203)	Microsoft ACPI-Compliant System
 (ISA) 0x000000CC (204)	Microsoft ACPI-Compliant System
 (ISA) 0x00000100 (256)	Microsoft ACPI-Compliant System
 (ISA) 0x00000101 (257)	Microsoft ACPI-Compliant System
 (ISA) 0x00000102 (258)	Microsoft ACPI-Compliant System
 (ISA) 0x00000103 (259)	Microsoft ACPI-Compliant System
 (ISA) 0x00000104 (260)	Microsoft ACPI-Compliant System
 (ISA) 0x00000105 (261)	Microsoft ACPI-Compliant System











































 (ISA) 0x00000105 (261)	Microsoft ACPI-Compliant System
 (ISA) 0x00000106 (262)	Microsoft ACPI-Compliant System
 (ISA) 0x00000107 (263)	Microsoft ACPI-Compliant System
 (ISA) 0x00000108 (264)	Microsoft ACPI-Compliant System
 (ISA) 0x00000109 (265)	Microsoft ACPI-Compliant System
 (ISA) 0x0000010A (266)	Microsoft ACPI-Compliant System
 (ISA) 0x0000010B (267)	Microsoft ACPI-Compliant System
 (ISA) 0x0000010C (268)	Microsoft ACPI-Compliant System
 (ISA) 0x0000010D (269)	Microsoft ACPI-Compliant System
 (ISA) 0x0000010E (270)	Microsoft ACPI-Compliant System
 (ISA) 0x0000010F (271)	Microsoft ACPI-Compliant System
 (ISA) 0x00000110 (272)	Microsoft ACPI-Compliant System
 (ISA) 0x00000111 (273)	Microsoft ACPI-Compliant System
 (ISA) 0x00000112 (274)	Microsoft ACPI-Compliant System
 (ISA) 0x00000113 (275)	Microsoft ACPI-Compliant System
 (ISA) 0x00000114 (276)	Microsoft ACPI-Compliant System
 (ISA) 0x00000115 (277)	Microsoft ACPI-Compliant System
 (ISA) 0x00000116 (278)	Microsoft ACPI-Compliant System
 (ISA) 0x00000117 (279)	Microsoft ACPI-Compliant System
 (ISA) 0x00000118 (280)	Microsoft ACPI-Compliant System
 (ISA) 0x00000119 (281)	Microsoft ACPI-Compliant System
 (ISA) 0x0000011A (282)	Microsoft ACPI-Compliant System
 (ISA) 0x0000011B (283)	Microsoft ACPI-Compliant System
 (ISA) 0x0000011C (284)	Microsoft ACPI-Compliant System
 (ISA) 0x0000011D (285)	Microsoft ACPI-Compliant System
 (ISA) 0x0000011E (286)	Microsoft ACPI-Compliant System
 (ISA) 0x0000011F (287)	Microsoft ACPI-Compliant System
 (ISA) 0x00000120 (288)	Microsoft ACPI-Compliant System
 (ISA) 0x00000121 (289)	Microsoft ACPI-Compliant System
 (ISA) 0x00000122 (290)	Microsoft ACPI-Compliant System
 (ISA) 0x00000123 (291)	Microsoft ACPI-Compliant System
 (ISA) 0x00000124 (292)	Microsoft ACPI-Compliant System
 (ISA) 0x00000125 (293)	Microsoft ACPI-Compliant System
 (ISA) 0x00000126 (294)	Microsoft ACPI-Compliant System
 (ISA) 0x00000127 (295)	Microsoft ACPI-Compliant System
 (ISA) 0x00000128 (296)	Microsoft ACPI-Compliant System
 (ISA) 0x00000129 (297)	Microsoft ACPI-Compliant System
 (ISA) 0x0000012A (298)	Microsoft ACPI-Compliant System
 (ISA) 0x0000012B (299)	Microsoft ACPI-Compliant System
 (ISA) 0x0000012C (300)	Microsoft ACPI-Compliant System
 (ISA) 0x0000012D (301)	Microsoft ACPI-Compliant System
 (ISA) 0x0000012E (302)	Microsoft ACPI-Compliant System











































 (ISA) 0x0000012E (302)	Microsoft ACPI-Compliant System
 (ISA) 0x0000012F (303)	Microsoft ACPI-Compliant System
 (ISA) 0x00000130 (304)	Microsoft ACPI-Compliant System
 (ISA) 0x00000131 (305)	Microsoft ACPI-Compliant System
 (ISA) 0x00000132 (306)	Microsoft ACPI-Compliant System
 (ISA) 0x00000133 (307)	Microsoft ACPI-Compliant System
 (ISA) 0x00000134 (308)	Microsoft ACPI-Compliant System
 (ISA) 0x00000135 (309)	Microsoft ACPI-Compliant System
 (ISA) 0x00000136 (310)	Microsoft ACPI-Compliant System
 (ISA) 0x00000137 (311)	Microsoft ACPI-Compliant System
 (ISA) 0x00000138 (312)	Microsoft ACPI-Compliant System
 (ISA) 0x00000139 (313)	Microsoft ACPI-Compliant System
 (ISA) 0x0000013A (314)	Microsoft ACPI-Compliant System
 (ISA) 0x0000013B (315)	Microsoft ACPI-Compliant System
 (ISA) 0x0000013C (316)	Microsoft ACPI-Compliant System
 (ISA) 0x0000013D (317)	Microsoft ACPI-Compliant System
 (ISA) 0x0000013E (318)	Microsoft ACPI-Compliant System
 (ISA) 0x0000013F (319)	Microsoft ACPI-Compliant System
 (ISA) 0x00000140 (320)	Microsoft ACPI-Compliant System
 (ISA) 0x00000141 (321)	Microsoft ACPI-Compliant System
 (ISA) 0x00000142 (322)	Microsoft ACPI-Compliant System
 (ISA) 0x00000143 (323)	Microsoft ACPI-Compliant System
 (ISA) 0x00000144 (324)	Microsoft ACPI-Compliant System
 (ISA) 0x00000145 (325)	Microsoft ACPI-Compliant System
 (ISA) 0x00000146 (326)	Microsoft ACPI-Compliant System
 (ISA) 0x00000147 (327)	Microsoft ACPI-Compliant System
 (ISA) 0x00000148 (328)	Microsoft ACPI-Compliant System
 (ISA) 0x00000149 (329)	Microsoft ACPI-Compliant System
 (ISA) 0x0000014A (330)	Microsoft ACPI-Compliant System
 (ISA) 0x0000014B (331)	Microsoft ACPI-Compliant System
 (ISA) 0x0000014C (332)	Microsoft ACPI-Compliant System
 (ISA) 0x0000014D (333)	Microsoft ACPI-Compliant System
 (ISA) 0x0000014E (334)	Microsoft ACPI-Compliant System
 (ISA) 0x0000014F (335)	Microsoft ACPI-Compliant System
 (ISA) 0x00000150 (336)	Microsoft ACPI-Compliant System
 (ISA) 0x00000151 (337)	Microsoft ACPI-Compliant System
 (ISA) 0x00000152 (338)	Microsoft ACPI-Compliant System
 (ISA) 0x00000153 (339)	Microsoft ACPI-Compliant System
 (ISA) 0x00000154 (340)	Microsoft ACPI-Compliant System
 (ISA) 0x00000155 (341)	Microsoft ACPI-Compliant System
 (ISA) 0x00000156 (342)	Microsoft ACPI-Compliant System
 (ISA) 0x00000157 (343)	Microsoft ACPI-Compliant System







 (ISA) 0x00000157 (343)	Microsoft ACPI-Compliant System
 (ISA) 0x00000158 (344)	Microsoft ACPI-Compliant System
 (ISA) 0x00000159 (345)	Microsoft ACPI-Compliant System
 (ISA) 0x0000015A (346)	Microsoft ACPI-Compliant System
 (ISA) 0x0000015B (347)	Microsoft ACPI-Compliant System
 (ISA) 0x0000015C (348)	Microsoft ACPI-Compliant System
 (ISA) 0x0000015D (349)	Microsoft ACPI-Compliant System
 (ISA) 0x0000015E (350)	Microsoft ACPI-Compliant System
 (ISA) 0x0000015F (351)	Microsoft ACPI-Compliant System
 (ISA) 0x00000160 (352)	Microsoft ACPI-Compliant System
 (ISA) 0x00000161 (353)	Microsoft ACPI-Compliant System
 (ISA) 0x00000162 (354)	Microsoft ACPI-Compliant System
 (ISA) 0x00000163 (355)	Microsoft ACPI-Compliant System
 (ISA) 0x00000164 (356)	Microsoft ACPI-Compliant System
 (ISA) 0x00000165 (357)	Microsoft ACPI-Compliant System
 (ISA) 0x00000166 (358)	Microsoft ACPI-Compliant System
 (ISA) 0x00000167 (359)	Microsoft ACPI-Compliant System
 (ISA) 0x00000168 (360)	Microsoft ACPI-Compliant System
 (ISA) 0x00000169 (361)	Microsoft ACPI-Compliant System
 (ISA) 0x0000016A (362)	Microsoft ACPI-Compliant System
 (ISA) 0x0000016B (363)	Microsoft ACPI-Compliant System
 (ISA) 0x0000016C (364)	Microsoft ACPI-Compliant System
 (ISA) 0x0000016D (365)	Microsoft ACPI-Compliant System
 (ISA) 0x0000016E (366)	Microsoft ACPI-Compliant System
 (ISA) 0x0000016F (367)	Microsoft ACPI-Compliant System
 (ISA) 0x00000170 (368)	Microsoft ACPI-Compliant System
 (ISA) 0x00000171 (369)	Microsoft ACPI-Compliant System
 (ISA) 0x00000172 (370)	Microsoft ACPI-Compliant System
 (ISA) 0x00000173 (371)	Microsoft ACPI-Compliant System
 (ISA) 0x00000174 (372)	Microsoft ACPI-Compliant System
 (ISA) 0x00000175 (373)	Microsoft ACPI-Compliant System
 (ISA) 0x00000176 (374)	Microsoft ACPI-Compliant System
 (ISA) 0x00000177 (375)	Microsoft ACPI-Compliant System
 (ISA) 0x00000178 (376)	Microsoft ACPI-Compliant System
 (ISA) 0x00000179 (377)	Microsoft ACPI-Compliant System
 (ISA) 0x0000017A (378)	Microsoft ACPI-Compliant System
 (ISA) 0x0000017B (379)	Microsoft ACPI-Compliant System
 (ISA) 0x0000017C (380)	Microsoft ACPI-Compliant System
 (ISA) 0x0000017D (381)	Microsoft ACPI-Compliant System
 (ISA) 0x0000017E (382)	Microsoft ACPI-Compliant System
 (ISA) 0x0000017F (383)	Microsoft ACPI-Compliant System
 (ISA) 0x00000180 (384)	Microsoft ACPI-Compliant System

 (ISA) 0x00000180 (384)	Microsoft ACPI-Compliant System
 (ISA) 0x00000181 (385)	Microsoft ACPI-Compliant System
 (ISA) 0x00000182 (386)	Microsoft ACPI-Compliant System
 (ISA) 0x00000183 (387)	Microsoft ACPI-Compliant System
 (ISA) 0x00000184 (388)	Microsoft ACPI-Compliant System
 (ISA) 0x00000185 (389)	Microsoft ACPI-Compliant System
 (ISA) 0x00000186 (390)	Microsoft ACPI-Compliant System
 (ISA) 0x00000187 (391)	Microsoft ACPI-Compliant System
 (ISA) 0x00000188 (392)	Microsoft ACPI-Compliant System
 (ISA) 0x00000189 (393)	Microsoft ACPI-Compliant System
 (ISA) 0x0000018A (394)	Microsoft ACPI-Compliant System
 (ISA) 0x0000018B (395)	Microsoft ACPI-Compliant System
 (ISA) 0x0000018C (396)	Microsoft ACPI-Compliant System
 (ISA) 0x0000018D (397)	Microsoft ACPI-Compliant System
 (ISA) 0x0000018E (398)	Microsoft ACPI-Compliant System
 (ISA) 0x0000018F (399)	Microsoft ACPI-Compliant System
 (ISA) 0x00000190 (400)	Microsoft ACPI-Compliant System
 (ISA) 0x00000191 (401)	Microsoft ACPI-Compliant System
 (ISA) 0x00000192 (402)	Microsoft ACPI-Compliant System
 (ISA) 0x00000193 (403)	Microsoft ACPI-Compliant System
 (ISA) 0x00000194 (404)	Microsoft ACPI-Compliant System
 (ISA) 0x00000195 (405)	Microsoft ACPI-Compliant System
 (ISA) 0x00000196 (406)	Microsoft ACPI-Compliant System
 (ISA) 0x00000197 (407)	Microsoft ACPI-Compliant System
 (ISA) 0x00000198 (408)	Microsoft ACPI-Compliant System
 (ISA) 0x00000199 (409)	Microsoft ACPI-Compliant System
 (ISA) 0x0000019A (410)	Microsoft ACPI-Compliant System
 (ISA) 0x0000019B (411)	Microsoft ACPI-Compliant System
 (ISA) 0x0000019C (412)	Microsoft ACPI-Compliant System
 (ISA) 0x0000019D (413)	Microsoft ACPI-Compliant System
 (ISA) 0x0000019E (414)	Microsoft ACPI-Compliant System
 (ISA) 0x0000019F (415)	Microsoft ACPI-Compliant System
 (ISA) 0x000001A0 (416)	Microsoft ACPI-Compliant System
 (ISA) 0x000001A1 (417)	Microsoft ACPI-Compliant System
 (ISA) 0x000001A2 (418)	Microsoft ACPI-Compliant System
 (ISA) 0x000001A3 (419)	Microsoft ACPI-Compliant System
 (ISA) 0x000001A4 (420)	Microsoft ACPI-Compliant System
 (ISA) 0x000001A5 (421)	Microsoft ACPI-Compliant System
 (ISA) 0x000001A6 (422)	Microsoft ACPI-Compliant System
 (ISA) 0x000001A7 (423)	Microsoft ACPI-Compliant System
 (ISA) 0x000001A8 (424)	Microsoft ACPI-Compliant System
 (ISA) 0x000001A9 (425)	Microsoft ACPI-Compliant System









































 (ISA) 0x000001A9 (425)	Microsoft ACPI-Compliant System
 (ISA) 0x000001AA (426)	Microsoft ACPI-Compliant System
 (ISA) 0x000001AB (427)	Microsoft ACPI-Compliant System
 (ISA) 0x000001AC (428)	Microsoft ACPI-Compliant System
 (ISA) 0x000001AD (429)	Microsoft ACPI-Compliant System
 (ISA) 0x000001AE (430)	Microsoft ACPI-Compliant System
 (ISA) 0x000001AF (431)	Microsoft ACPI-Compliant System
 (ISA) 0x000001B0 (432)	Microsoft ACPI-Compliant System
 (ISA) 0x000001B1 (433)	Microsoft ACPI-Compliant System
 (ISA) 0x000001B2 (434)	Microsoft ACPI-Compliant System
 (ISA) 0x000001B3 (435)	Microsoft ACPI-Compliant System
 (ISA) 0x000001B4 (436)	Microsoft ACPI-Compliant System
 (ISA) 0x000001B5 (437)	Microsoft ACPI-Compliant System
 (ISA) 0x000001B6 (438)	Microsoft ACPI-Compliant System
 (ISA) 0x000001B7 (439)	Microsoft ACPI-Compliant System
 (ISA) 0x000001B8 (440)	Microsoft ACPI-Compliant System
 (ISA) 0x000001B9 (441)	Microsoft ACPI-Compliant System
 (ISA) 0x000001BA (442)	Microsoft ACPI-Compliant System
 (ISA) 0x000001BB (443)	Microsoft ACPI-Compliant System
 (ISA) 0x000001BC (444)	Microsoft ACPI-Compliant System
 (ISA) 0x000001BD (445)	Microsoft ACPI-Compliant System
 (ISA) 0x000001BE (446)	Microsoft ACPI-Compliant System
 (ISA) 0x000001BF (447)	Microsoft ACPI-Compliant System
 (ISA) 0x000001C0 (448)	Microsoft ACPI-Compliant System
 (ISA) 0x000001C1 (449)	Microsoft ACPI-Compliant System
 (ISA) 0x000001C2 (450)	Microsoft ACPI-Compliant System
 (ISA) 0x000001C3 (451)	Microsoft ACPI-Compliant System
 (ISA) 0x000001C4 (452)	Microsoft ACPI-Compliant System
 (ISA) 0x000001C5 (453)	Microsoft ACPI-Compliant System
 (ISA) 0x000001C6 (454)	Microsoft ACPI-Compliant System
 (ISA) 0x000001C7 (455)	Microsoft ACPI-Compliant System
 (ISA) 0x000001C8 (456)	Microsoft ACPI-Compliant System
 (ISA) 0x000001C9 (457)	Microsoft ACPI-Compliant System
 (ISA) 0x000001CA (458)	Microsoft ACPI-Compliant System
 (ISA) 0x000001CB (459)	Microsoft ACPI-Compliant System
 (ISA) 0x000001CC (460)	Microsoft ACPI-Compliant System
 (ISA) 0x000001CD (461)	Microsoft ACPI-Compliant System
 (ISA) 0x000001CE (462)	Microsoft ACPI-Compliant System
 (ISA) 0x000001CF (463)	Microsoft ACPI-Compliant System
 (ISA) 0x000001D0 (464)	Microsoft ACPI-Compliant System
 (ISA) 0x000001D1 (465)	Microsoft ACPI-Compliant System
 (ISA) 0x000001D2 (466)	Microsoft ACPI-Compliant System

 (ISA) 0x000001D2 (466)	Microsoft ACPI-Compliant System
 (ISA) 0x000001D3 (467)	Microsoft ACPI-Compliant System
 (ISA) 0x000001D4 (468)	Microsoft ACPI-Compliant System
 (ISA) 0x000001D5 (469)	Microsoft ACPI-Compliant System
 (ISA) 0x000001D6 (470)	Microsoft ACPI-Compliant System
 (ISA) 0x000001D7 (471)	Microsoft ACPI-Compliant System
 (ISA) 0x000001D8 (472)	Microsoft ACPI-Compliant System
 (ISA) 0x000001D9 (473)	Microsoft ACPI-Compliant System
 (ISA) 0x000001DA (474)	Microsoft ACPI-Compliant System
 (ISA) 0x000001DB (475)	Microsoft ACPI-Compliant System
 (ISA) 0x000001DC (476)	Microsoft ACPI-Compliant System
 (ISA) 0x000001DD (477)	Microsoft ACPI-Compliant System
 (ISA) 0x000001DE (478)	Microsoft ACPI-Compliant System
 (ISA) 0x000001DF (479)	Microsoft ACPI-Compliant System
 (ISA) 0x000001E0 (480)	Microsoft ACPI-Compliant System
 (ISA) 0x000001E1 (481)	Microsoft ACPI-Compliant System
 (ISA) 0x000001E2 (482)	Microsoft ACPI-Compliant System
 (ISA) 0x000001E3 (483)	Microsoft ACPI-Compliant System
 (ISA) 0x000001E4 (484)	Microsoft ACPI-Compliant System
 (ISA) 0x000001E5 (485)	Microsoft ACPI-Compliant System
 (ISA) 0x000001E6 (486)	Microsoft ACPI-Compliant System
 (ISA) 0x000001E7 (487)	Microsoft ACPI-Compliant System
 (ISA) 0x000001E8 (488)	Microsoft ACPI-Compliant System
 (ISA) 0x000001E9 (489)	Microsoft ACPI-Compliant System
 (ISA) 0x000001EA (490)	Microsoft ACPI-Compliant System
 (ISA) 0x000001EB (491)	Microsoft ACPI-Compliant System
 (ISA) 0x000001EC (492)	Microsoft ACPI-Compliant System
 (ISA) 0x000001ED (493)	Microsoft ACPI-Compliant System
 (ISA) 0x000001EE (494)	Microsoft ACPI-Compliant System
 (ISA) 0x000001EF (495)	Microsoft ACPI-Compliant System
 (ISA) 0x000001F0 (496)	Microsoft ACPI-Compliant System
 (ISA) 0x000001F1 (497)	Microsoft ACPI-Compliant System
 (ISA) 0x000001F2 (498)	Microsoft ACPI-Compliant System
 (ISA) 0x000001F3 (499)	Microsoft ACPI-Compliant System
 (ISA) 0x000001F4 (500)	Microsoft ACPI-Compliant System
 (ISA) 0x000001F5 (501)	Microsoft ACPI-Compliant System
 (ISA) 0x000001F6 (502)	Microsoft ACPI-Compliant System
 (ISA) 0x000001F7 (503)	Microsoft ACPI-Compliant System
 (ISA) 0x000001F8 (504)	Microsoft ACPI-Compliant System
 (ISA) 0x000001F9 (505)	Microsoft ACPI-Compliant System
 (ISA) 0x000001FA (506)	Microsoft ACPI-Compliant System
 (ISA) 0x000001FB (507)	Microsoft ACPI-Compliant System

	(ISA) 0x000001FB (507)	Microsoft ACPI-Compliant System
	(ISA) 0x000001FC (508)	Microsoft ACPI-Compliant System
	(ISA) 0x000001FD (509)	Microsoft ACPI-Compliant System
	(ISA) 0x000001FE (510)	Microsoft ACPI-Compliant System
	(ISA) 0x000001FF (511)	Microsoft ACPI-Compliant System
	(PCI) 0x00000010 (16)	High Definition Audio Controller
	(PCI) 0x00000010 (16)	Intel SD Host Controller
	(PCI) 0xFFFFFD6 (-42)	Intel(R) Management Engine Interface
	(PCI) 0xFFFFFD7 (-41)	Intel(R) I211 Gigabit Network Connection #2
	(PCI) 0xFFFFFD8 (-40)	Intel(R) I211 Gigabit Network Connection #2
	(PCI) 0xFFFFFD9 (-39)	Intel(R) I211 Gigabit Network Connection #2
	(PCI) 0xFFFFFDA (-38)	Intel(R) I211 Gigabit Network Connection #2
	(PCI) 0xFFFFFDB (-37)	Intel(R) I211 Gigabit Network Connection #2
	(PCI) 0xFFFFFDC (-36)	Intel(R) I211 Gigabit Network Connection #2
	(PCI) 0xFFFFFDD (-35)	Intel(R) I211 Gigabit Network Connection #3
	(PCI) 0xFFFFFDE (-34)	Intel(R) I211 Gigabit Network Connection #3
	(PCI) 0xFFFFFDF (-33)	Intel(R) I211 Gigabit Network Connection #3
	(PCI) 0xFFFFFE0 (-32)	Intel(R) I211 Gigabit Network Connection #3
	(PCI) 0xFFFFFE1 (-31)	Intel(R) I211 Gigabit Network Connection #3
	(PCI) 0xFFFFFE2 (-30)	Intel(R) I211 Gigabit Network Connection #3
	(PCI) 0xFFFFFE3 (-29)	Intel(R) I211 Gigabit Network Connection #5
	(PCI) 0xFFFFFE4 (-28)	Intel(R) I211 Gigabit Network Connection #5
	(PCI) 0xFFFFFE5 (-27)	Intel(R) I211 Gigabit Network Connection #5
	(PCI) 0xFFFFFE6 (-26)	Intel(R) I211 Gigabit Network Connection #5
	(PCI) 0xFFFFFE7 (-25)	Intel(R) I211 Gigabit Network Connection #5
	(PCI) 0xFFFFFE8 (-24)	Intel(R) I211 Gigabit Network Connection #5
	(PCI) 0xFFFFFE9 (-23)	Intel(R) I211 Gigabit Network Connection
	(PCI) 0xFFFFFEA (-22)	Intel(R) I211 Gigabit Network Connection
	(PCI) 0xFFFFFEB (-21)	Intel(R) I211 Gigabit Network Connection
	(PCI) 0xFFFFFEC (-20)	Intel(R) I211 Gigabit Network Connection
	(PCI) 0xFFFFFED (-19)	Intel(R) I211 Gigabit Network Connection
	(PCI) 0xFFFFFEE (-18)	Intel(R) I211 Gigabit Network Connection
	(PCI) 0xFFFFFEF (-17)	Intel(R) I211 Gigabit Network Connection #4
	(PCI) 0xFFFFFF0 (-16)	Intel(R) I211 Gigabit Network Connection #4
	(PCI) 0xFFFFFF1 (-15)	Intel(R) I211 Gigabit Network Connection #4
	(PCI) 0xFFFFFF2 (-14)	Intel(R) I211 Gigabit Network Connection #4
	(PCI) 0xFFFFFF3 (-13)	Intel(R) I211 Gigabit Network Connection #4
	(PCI) 0xFFFFFF4 (-12)	Intel(R) I211 Gigabit Network Connection #4
	(PCI) 0xFFFFFF5 (-11)	Intel(R) USB 3.1 eXtensible Host Controller - 1.10 (Microsoft)
	(PCI) 0xFFFFFF6 (-10)	Intel(R) UHD Graphics 620
	(PCI) 0xFFFFFF7 (-9)	Standard SATA AHCI Controller
	(PCI) 0xFFFFFF8 (-8)	Intel(R) PCI Express Root Port #9 - 9DB0

 (PCI) 0xFFFFFFFF8 (-8)	Intel(R) PCI Express Root Port #9 - 9DB0
 (PCI) 0xFFFFFFFF9 (-7)	Intel(R) PCI Express Root Port #1 - 9DB8
 (PCI) 0xFFFFFFFFFA (-6)	Intel(R) PCI Express Root Port #8 - 9DBF
 (PCI) 0xFFFFFFFFFB (-5)	Intel(R) PCI Express Root Port #7 - 9DBE
 (PCI) 0xFFFFFFFFFC (-4)	Intel(R) PCI Express Root Port #6 - 9DBD
 (PCI) 0xFFFFFFFFFD (-3)	Intel(R) PCI Express Root Port #5 - 9DBC
 (PCI) 0xFFFFFFFFFE (-2)	Intel(R) PCI Express Root Port #10 - 9DB1

A.3 Memory Address Map

	[0000000000A00000 - 0000000000BFFFFF]	PCI Express Root Complex
	[0000000040000000 - 00000000403FFFFF]	Motherboard resources
	[0000000090000000 - 000000009FFFFFFF]	Intel(R) UHD Graphics 620
	[0000000090000000 - 00000000DFFFFFFF]	PCI Express Root Complex
	[00000000A0000000 - 00000000A0FFFFFFF]	Intel(R) UHD Graphics 620
	[00000000A1100000 - 00000000A11FFFFFFF]	Intel(R) PCI Express Root Port #10 - 9DB1
	[00000000A11DC000 - 00000000A11DFFFFF]	Intel(R) I211 Gigabit Network Connection #5
	[00000000A11E0000 - 00000000A11FFFFFFF]	Intel(R) I211 Gigabit Network Connection #5
	[00000000A1200000 - 00000000A12FFFFFFF]	Intel(R) PCI Express Root Port #8 - 9DBF
	[00000000A12DC000 - 00000000A12DFFFFF]	Intel(R) I211 Gigabit Network Connection #3
	[00000000A12E0000 - 00000000A12FFFFFFF]	Intel(R) I211 Gigabit Network Connection #3
	[00000000A1300000 - 00000000A13FFFFFFF]	Intel(R) PCI Express Root Port #7 - 9DBE
	[00000000A13DC000 - 00000000A13DFFFFF]	Intel(R) I211 Gigabit Network Connection #2
	[00000000A13E0000 - 00000000A13FFFFFFF]	Intel(R) I211 Gigabit Network Connection #2
	[00000000A1400000 - 00000000A141FFFFF]	Intel(R) I211 Gigabit Network Connection
	[00000000A1400000 - 00000000A14FFFFFFF]	Intel(R) PCI Express Root Port #6 - 9DBD
	[00000000A1420000 - 00000000A1423FFF]	Intel(R) I211 Gigabit Network Connection
	[00000000A1500000 - 00000000A151FFFFF]	Intel(R) I211 Gigabit Network Connection #4
	[00000000A1500000 - 00000000A15FFFFFFF]	Intel(R) PCI Express Root Port #5 - 9DBC
	[00000000A1500000 - 00000000A15FFFFFFF]	PCI Express Downstream Switch Port
	[00000000A1500000 - 00000000A15FFFFFFF]	PCI Express Upstream Switch Port
	[00000000A1520000 - 00000000A1523FFF]	Intel(R) I211 Gigabit Network Connection #4
	[00000000A1600000 - 00000000A160FFFFF]	Intel(R) USB 3.1 eXtensible Host Controller - 1.10 (Microsoft)
	[00000000A161C000 - 00000000A161DFFF]	Standard SATA AHCI Controller
	[00000000A1620000 - 00000000A16200FF]	Intel(R) SMBus - 9DA3
	[00000000A1621000 - 00000000A1621FFF]	Intel SD Host Controller
	[00000000A1622000 - 00000000A16227FF]	Standard SATA AHCI Controller
	[00000000A1623000 - 00000000A16230FF]	Standard SATA AHCI Controller
	[00000000E0000000 - 00000000EFFFFFFF]	Motherboard resources
	[00000000FC800000 - 00000000FE7FFFFF]	PCI Express Root Complex
	[00000000FD000000 - 00000000FD69FFFFF]	Motherboard resources
	[00000000FD6A0000 - 00000000FD6AFFFFF]	Intel(R) Serial IO GPIO Host Controller - INT34BB
	[00000000FD6B0000 - 00000000FD6CFFFFF]	Motherboard resources
	[00000000FD6D0000 - 00000000FD6DFFFFF]	Intel(R) Serial IO GPIO Host Controller - INT34BB
	[00000000FD6E0000 - 00000000FD6EFFFFF]	Intel(R) Serial IO GPIO Host Controller - INT34BB
	[00000000FD6F0000 - 00000000FDFFFFFFF]	Motherboard resources
	[00000000FE000000 - 00000000FE01FFFFF]	Motherboard resources
	[00000000FE010000 - 00000000FE010FFF]	Intel(R) SPI (flash) Controller - 9DA4
	[00000000FE0FB000 - 00000000FE0FBFFF]	Intel(R) Management Engine Interface
	[00000000FE0FC000 - 00000000FE0FFFFF]	High Definition Audio Controller
	[00000000FE100000 - 00000000FE11FFFFF]	High Definition Audio Controller

 [00000000FE10000 - 00000000FE1FFFFF]	High Definition Audio Controller
 [00000000FE20000 - 00000000FE7FFFFF]	Motherboard resources
 [00000000FED00000 - 00000000FED003FF]	High precision event timer
 [00000000FED10000 - 00000000FED17FFF]	Motherboard resources
 [00000000FED18000 - 00000000FED18FFF]	Motherboard resources
 [00000000FED19000 - 00000000FED19FFF]	Motherboard resources
 [00000000FED20000 - 00000000FED3FFFF]	Motherboard resources
 [00000000FED45000 - 00000000FED8FFFF]	Motherboard resources
 [00000000FED90000 - 00000000FED93FFF]	Motherboard resources
 [00000000FEE00000 - 00000000FEEFFFFF]	Motherboard resources
 [00000000FF000000 - 00000000FFFFFFFF]	Motherboard resources

Appendix B

Watchdog Timer Programming

B.1 Watchdog Timer Initial Program

Table 1 : SuperIO relative register table		
	Default Value	Note
Index	0x2E(Note1)	SIO MB PnP Mode Index Register 0x2E or 0x4E
Data	0x2F(Note2)	SIO MB PnP Mode Data Register 0x2F or 0x4F

Table 2 : Watchdog relative register table					
	LDN	Register	BitNum	Value	Note
Timer Counter	0x07(Note3)	0x73(Note4)		(Note24)	Time of watchdog timer (0~255) This register is byte access
Counting Unit	0x07(Note5)	0x72(Note6)	7(Note7)	1(Note8)	Select time unit. 1: second 0: minute
Watchdog Enable (KRST)	0x07(Note9)	0x72(Note10)	6(Note11)	1(Note12)	0: Disable 1: Enable
Timeout Status	0x07(Note13)	0x71(Note14)	0(Note15)	1	1: Clear timeout status
Output Mode	0x07(Note16)	0xF5(Note17)	4(Note18)	1(Note19)	Select WDTRST# output mode 0: level 1: pulse
WDTRST output	0x07(Note20)	0xFA(Note21)	0(Note22)	1(Note23)	Enable/Disable time out output via WDTRST# 0: Disable 1: Enable

```

*****
// SuperIO relative definition (Please reference to Table 1)
#define byte SIOIndex //This parameter is represented from Note1
#define byte SIOData //This parameter is represented from Note2
#define void IOWriteByte(byte IOPort, byte Value);
#define byte IOReadByte(byte IOPort);
// Watch Dog relative definition (Please reference to Table 2)
#define byte TimerLDN //This parameter is represented from Note3
#define byte TimerReg //This parameter is represented from Note4
#define byte TimerVal // This parameter is represented from Note24
#define byte UnitLDN //This parameter is represented from Note5
#define byte UnitReg //This parameter is represented from Note6
#define byte UnitBit //This parameter is represented from Note7
#define byte UnitVal //This parameter is represented from Note8
#define byte EnableLDN //This parameter is represented from Note9
#define byte EnableReg //This parameter is represented from Note10
#define byte EnableBit //This parameter is represented from Note11
#define byte EnableVal //This parameter is represented from Note12
#define byte StatusLDN // This parameter is represented from Note13
#define byte StatusReg // This parameter is represented from Note14
#define byte StatusBit // This parameter is represented from Note15
#define byte ModeLDN // This parameter is represented from Note16
#define byte ModeReg // This parameter is represented from Note17
#define byte ModeBit // This parameter is represented from Note18
#define byte ModeVal // This parameter is represented from Note19
#define byte WDRstLDN // This parameter is represented from Note20
#define byte WDRstReg // This parameter is represented from Note21
#define byte WDRstBit // This parameter is represented from Note22
#define byte WDRstVal // This parameter is represented from Note23
*****

```

```
*****
VOID Main() {
    // Procedure : AaeonWDTConfig
    // (byte)Timer : Time of WDT timer.(0x00~0xFF)
    // (boolean)Unit : Select time unit(0: second, 1: minute).
    AaeonWDTConfig();

    // Procedure : AaeonWDTEnable
    // This procedure will enable the WDT counting.
    AaeonWDTEnable();
}
*****
```

```

*****
// Procedure : AaeonWDTEnable
VOID AaeonWDTEnable (){
    WDTEnableDisable(EnableLDN, EnableReg, EnableBit, 1);
}

// Procedure : AaeonWDTConfig
VOID AaeonWDTConfig (){
    // Disable WDT counting
    WDTEnableDisable(EnableLDN, EnableReg, EnableBit, 0);
    // Clear Watchdog Timeout Status
    WDTClearTimeoutStatus();
    // WDT relative parameter setting
    WDTParameterSetting();
}

VOID WDTEnableDisable(byte LDN, byte Register, byte BitNum, byte Value){
    SIOBitSet(LDN, Register, BitNum, Value);
}

VOID WDTParameterSetting(){
    // Watchdog Timer counter setting
    SIOByteSet(TimerLDN, TimerReg, TimerVal);
    // WDT counting unit setting
    SIOBitSet(UnitLDN, UnitReg, UnitBit, UnitVal);
    // WDT output mode setting, level / pulse
    SIOBitSet(ModeLDN, ModeReg, ModeBit, ModeVal);
    // Watchdog timeout output via WDTRST#
    SIOBitSet(WDTRstLDN, WDTRstReg, WDTRstBit, WDTRstVal);
}

VOID WDTClearTimeoutStatus(){
    SIOBitSet(StatusLDN, StatusReg, StatusBit, 1);
}
*****

```

```
*****
VOID SIOEnterMBPnPMode(){
    IOWriteByte(SIOIndex, 0x87);
    IOWriteByte(SIOIndex, 0x87);
}

VOID SIOExitMBPnPMode(){
    IOWriteByte(SIOIndex, 0xAA);
}

VOID SIOSelectLDN(byte LDN){
    IOWriteByte(SIOIndex, 0x07); // SIO LDN Register Offset = 0x07
    IOWriteByte(SIOData, LDN);
}

VOID SIOBitSet(byte LDN, byte Register, byte BitNum, byte Value){
    Byte TmpValue;

    SIOEnterMBPnPMode();
    SIOSelectLDN(byte LDN);
    IOWriteByte(SIOIndex, Register);
    TmpValue = IOReadByte(SIOData);
    TmpValue &= ~(1 << BitNum);
    TmpValue |= (Value << BitNum);
    IOWriteByte(SIOData, TmpValue);
    SIOExitMBPnPMode();
}

VOID SIOByteSet(byte LDN, byte Register, byte Value){
    SIOEnterMBPnPMode();
    SIOSelectLDN(LDN);
    IOWriteByte(SIOIndex, Register);
    IOWriteByte(SIOData, Value);
    SIOExitMBPnPMode();
}
*****
```

Appendix C

Electrical Specifications for I/O Ports

C.1 Digital I/O Register

	Default Value	Note
Index	0x2E(Note1)	SIO MB PnP Mode Index Register 0x2E or 0x4E
Data	0x2F(Note2)	SIO MB PnP Mode Data Register 0x2F or 0x4F

	LDN	Register	BitNum	Value	Note
DIO-1 Pin Status	0x06(Note3)	0x8A(Note4)	0(Note5)		GPIO80
DIO-2 Pin Status	0x06(Note6)	0x8A (Note7)	1(Note8)		GPIO81
DIO-3 Pin Status	0x06(Note9)	0x8A (Note10)	3(Note11)		GPIO83
DIO-4 Pin Status	0x06(Note12)	0x8A (Note13)	2(Note14)		GPIO82
DIO-5 Pin Status	0x06(Note15)	0x8A (Note16)	5(Note17)		GPIO85
DIO-6 Pin Status	0x06(Note18)	0x8A (Note19)	4(Note20)		GPIO84
DIO-7 Pin Status	0x06(Note21)	0x8A (Note22)	6(Note23)		GPIO86
DIO-8 Pin Status	0x06(Note24)	0x8A (Note25)	7(Note26)		GPIO87

Table 3 : Digital Output relative register table					
	LDN	Register	BitNum	Value	Note
DIO-1 Output Data	0x06(Note27)	0x89(Note28)	0(Note29)	(Note30)	GPIO80
DIO-2 Output Data	0x06(Note31)	0x89 (Note32)	1(Note33)	(Note34)	GPIO81
DIO-3 Output Data	0x06(Note35)	0x89 (Note36)	3(Note37)	(Note38)	GPIO83
DIO-4 Output Data	0x06(Note39)	0x89 (Note40)	2(Note41)	(Note42)	GPIO82
DIO-5 Output Data	0x06(Note43)	0x89 (Note44)	5(Note45)	(Note46)	GPIO85
DIO-6 Output Data	0x06(Note47)	0x89 (Note48)	4(Note49)	(Note50)	GPIO84
DIO-7 Output Data	0x06(Note51)	0x89 (Note52)	6(Note53)	(Note54)	GPIO86
DIO-8 Output Data	0x06(Note55)	0x89 (Note56)	7(Note57)	(Note58)	GPIO87

C.2 Digital I/O Sample Program

```
*****
// SuperIO relative definition (Please reference to Table 1)
#define byte SIOIndex //This parameter is represented from Note1
#define byte SIOData //This parameter is represented from Note2
#define void IOWriteByte(byte IOPort, byte Value);
#define byte IOReadByte(byte IOPort);
// Digital Input Status relative definition (Please reference to Table 2)
#define byte DInput1LDN // This parameter is represented from Note3
#define byte DInput1Reg // This parameter is represented from Note4
#define byte DInput1Bit // This parameter is represented from Note5
#define byte DInput2LDN // This parameter is represented from Note6
#define byte DInput2Reg // This parameter is represented from Note7
#define byte DInput2Bit // This parameter is represented from Note8
#define byte DInput3LDN // This parameter is represented from Note9
#define byte DInput3Reg // This parameter is represented from Note10
#define byte DInput3Bit // This parameter is represented from Note11
#define byte DInput4LDN // This parameter is represented from Note12
#define byte DInput4Reg // This parameter is represented from Note13
#define byte DInput4Bit // This parameter is represented from Note14
#define byte DInput5LDN // This parameter is represented from Note15
#define byte DInput5Reg // This parameter is represented from Note16
#define byte DInput5Bit // This parameter is represented from Note17
#define byte DInput6LDN // This parameter is represented from Note18
#define byte DInput6Reg // This parameter is represented from Note19
#define byte DInput6Bit // This parameter is represented from Note20
#define byte DInput7LDN // This parameter is represented from Note21
#define byte DInput7Reg // This parameter is represented from Note22
#define byte DInput7Bit // This parameter is represented from Note23
#define byte DInput8LDN // This parameter is represented from Note24
#define byte DInput8Reg // This parameter is represented from Note25
#define byte DInput8Bit // This parameter is represented from Note26
*****
```

```

*****
// Digital Output control relative definition (Please reference to Table 3)
#define byte   DOutput1LDN // This parameter is represented from Note27
#define byte   DOutput1Reg // This parameter is represented from Note28
#define byte   DOutput1Bit // This parameter is represented from Note29
#define byte   DOutput1Val // This parameter is represented from Note30
#define byte   DOutput2LDN // This parameter is represented from Note31
#define byte   DOutput2Reg // This parameter is represented from Note32
#define byte   DOutput2Bit // This parameter is represented from Note33
#define byte   DOutput2Val // This parameter is represented from Note34
#define byte   DOutput3LDN // This parameter is represented from Note35
#define byte   DOutput3Reg // This parameter is represented from Note36
#define byte   DOutput3Bit // This parameter is represented from Note37
#define byte   DOutput3Val // This parameter is represented from Note38
#define byte   DOutput4LDN // This parameter is represented from Note39
#define byte   DOutput4Reg // This parameter is represented from Note40
#define byte   DOutput4Bit // This parameter is represented from Note41
#define byte   DOutput4Val // This parameter is represented from Note42
#define byte   DOutput5LDN // This parameter is represented from Note43
#define byte   DOutput5Reg // This parameter is represented from Note44
#define byte   DOutput5Bit // This parameter is represented from Note45
#define byte   DOutput5Val // This parameter is represented from Note46
#define byte   DOutput6LDN // This parameter is represented from Note47
#define byte   DOutput6Reg // This parameter is represented from Note48
#define byte   DOutput6Bit // This parameter is represented from Note49
#define byte   DOutput6Val // This parameter is represented from Note50
#define byte   DOutput7LDN // This parameter is represented from Note51
#define byte   DOutput7Reg // This parameter is represented from Note52
#define byte   DOutput7Bit // This parameter is represented from Note53
#define byte   DOutput7Val // This parameter is represented from Note54
#define byte   DOutput8LDN // This parameter is represented from Note55
#define byte   DOutput8Reg // This parameter is represented from Note56
#define byte   DOutput8Bit // This parameter is represented from Note57
#define byte   DOutput8Val // This parameter is represented from Note58
*****

```

```
*****
VOID Main() {
    Boolean PinStatus ;

    // Procedure : AaeonReadPinStatus
    // Input :
    //     Example, Read Digital I/O Pin 3 status
    // Output :
    //     InputStatus :
    //         0: Digital I/O Pin level is low
    //         1: Digital I/O Pin level is High
    PinStatus = AaeonReadPinStatus(DInput3LDN, DInput3Reg, DInput3Bit);

    // Procedure : AaeonSetOutputLevel
    // Input :
    //     Example, Set Digital I/O Pin 6 level
    AaeonSetOutputLevel(DOutput6LDN, DOutput6Reg, DOutput6Bit, DOutput6Val);
}
*****
```

```
*****
Boolean AaeonReadPinStatus(byte LDN, byte Register, byte BitNum){
    Boolean PinStatus ;

    PinStatus = SIOBitRead(LDN, Register, BitNum);
    Return PinStatus ;
}
VOID AaeonSetOutputLevel(byte LDN, byte Register, byte BitNum, byte Value){
    ConfigToOutputMode(LDN, Register, BitNum);
    SIOBitSet(LDN, Register, BitNum, Value);
}
*****
```

```

*****
VOID SIOEnterMBPnPMode(){
    IOWriteByte(SIOIndex, 0x87);
    IOWriteByte(SIOIndex, 0x87);
}

VOID SIOExitMBPnPMode(){
    IOWriteByte(SIOIndex, 0xAA);
}

VOID SIOSelectLDN(byte LDN){
    IOWriteByte(SIOIndex, 0x07); // SIO LDN Register Offset = 0x07
    IOWriteByte(SIOData, LDN);
}

VOID SIOBitSet(byte LDN, byte Register, byte BitNum, byte Value){
    Byte TmpValue;

    SIOEnterMBPnPMode();
    SIOSelectLDN(byte LDN);
    IOWriteByte(SIOIndex, Register);
    TmpValue = IOReadByte(SIOData);
    TmpValue &= ~(1 << BitNum);
    TmpValue |= (Value << BitNum);
    IOWriteByte(SIOData, TmpValue);
    SIOExitMBPnPMode();
}

VOID SIOByteSet(byte LDN, byte Register, byte Value){
    SIOEnterMBPnPMode();
    SIOSelectLDN(LDN);
    IOWriteByte(SIOIndex, Register);
    IOWriteByte(SIOData, Value);
    SIOExitMBPnPMode();
}
*****

```

```

*****
Boolean SIOBitRead(byte LDN, byte Register, byte BitNum){
    Byte TmpValue;

    SIOEnterMBPnPMode();
    SIOSelectLDN(LDN);
    IOWriteByte(SIOIndex, Register);
    TmpValue = IOReadByte(SIOData);
    TmpValue &= (1 << BitNum);
    SIOExitMBPnPMode();
    If(TmpValue == 0)
        Return 0;
    Return 1;
}

VOID ConfigToOutputMode(byte LDN, byte Register, byte BitNum){
    Byte TmpValue, OutputEnableReg;

    OutputEnableReg = Register-1;
    SIOEnterMBPnPMode();
    SIOSelectLDN(LDN);
    IOWriteByte(SIOIndex, OutputEnableReg);
    TmpValue = IOReadByte(SIOData);
    TmpValue |= (1 << BitNum);
    IOWriteByte(SIOData, OutputEnableReg);
    SIOExitMBPnPMode();
}
*****

```