

BOXER-6751-ADP

Fanless Embedded Box PC

User's Manual 1st Ed

Copyright Notice

This document is copyrighted, 2023. All rights are reserved. The original manufacturer reserves the right to make improvements to the products described in this manual at any time without notice.

No part of this manual may be reproduced, copied, translated, or transmitted in any form or by any means without the prior written permission of the original manufacturer. Information provided in this manual is intended to be accurate and reliable. However, the original manufacturer assumes no responsibility for its use, or for any infringements upon the rights of third parties that may result from its use.

The material in this document is for product information only and is subject to change without notice. While reasonable efforts have been made in the preparation of this document to assure its accuracy, AAEON assumes no liabilities resulting from errors or omissions in this document, or from the use of the information contained herein.

AAEON reserves the right to make changes in the product design without notice to its users.

Acknowledgement

All other product name or trademarks are properties of their respective owners.

- Microsoft Windows®, Windows® 10, and Windows® 11 are registered trademarks of Microsoft Corp.
- Intel® is a registered trademark of Intel Corporation.
- Intel® Core™ is a trademark of Intel Corporation.
- Linux® is a registered trademark of Linus Torvalds in the U.S. and other countries.
- Ubuntu and Canonical are registered trademarks of Canonical Ltd.

All other product names or trademarks are properties of their respective owners. The publisher of this document does not assume nor imply ownership of any trademarked product not listed herein.

Packing List

Before setting up your product, please make sure the following items have been shipped:

Item	Quantity
● BOXER-6751-ADP	1
● DIN Rail Kit	1
● 3 Pin DC-in Power Connector	1
● Screw Pack	1

If any of these items are missing or damaged, please contact your distributor or sales representative immediately.

About this Document

This User's Manual contains all the essential information, such as detailed descriptions and explanations on the product's hardware and software features (if any), its specifications, dimensions, jumper/connector settings/definitions, and driver installation instructions (if any), to facilitate users in setting up their product.

Users may refer to the product page at AAEON.com for the latest version of this document.

Safety Precautions

Please read the following safety instructions carefully. It is advised that you keep this manual for future references

1. All cautions and warnings on the device should be noted.
2. Make sure the power source matches the power rating of the device.
3. Position the power cord so that people cannot step on it. Do not place anything over the power cord.
4. Always completely disconnect the power before working on the system's hardware.
5. No connections should be made when the system is powered as a sudden rush of power may damage sensitive electronic components.
6. If the device is not to be used for a long time, disconnect it from the power supply to avoid damage by transient over-voltage.
7. Always disconnect this device from any power supply before cleaning.
8. While cleaning, use a damp cloth instead of liquid or spray detergents.
9. Make sure the device is installed near a power outlet and is easily accessible.
10. Keep this device away from humidity.
11. Place the device on a solid surface during installation to prevent falls.
12. Do not cover the openings on the device to ensure optimal heat dissipation.
13. Watch out for high temperatures when the system is running.
14. Do not touch the heat sink or heat spreader when the system is running
15. Never pour any liquid into the openings. This could cause fire or electric shock.
16. As most electronic components are sensitive to static electrical charge, be sure to ground yourself to prevent static charge when installing the internal components. Use a grounding wrist strap and contain all electronic components in any static-shielded containers.

17. If any of the following situations arises, please contact our service personnel:
 - i. Damaged power cord or plug
 - ii. Liquid intrusion to the device
 - iii. Exposure to moisture
 - iv. Device is not working as expected or in a manner as described in this manual
 - v. The device is dropped or damaged
 - vi. Any obvious signs of damage displayed on the device
18. Do not leave this device in an uncontrolled environment with temperatures beyond the device's permitted storage temperatures (see chapter 1) to prevent damage.
19. Do NOT disassemble the motherboard so as not to damage the system or void your warranty.
20. If the thermal pad had been damaged, please contact AAEON's salesperson to purchase a new one. Do NOT use those of other brands.
21. The Hex Cylinder Coppers on the front panel are not removable.
22. Repeatedly assemble and disassemble the system may cause damages to the exterior paint and surface and screw holes.
23. Use the right size screwdriver.
24. Use the screwdriver correctly to remove screws from the system.

FCC Statement

Warning!



This device complies with Part 15 FCC Rules. Operation is subject to the following two conditions: (1) this device may not cause harmful interference, and (2) this device must accept any interference received including interference that may cause undesired operation.

Caution:

There is a danger of explosion if the battery is incorrectly replaced. Replace only with the same or equivalent type recommended by the manufacturer. Dispose of used batteries according to the manufacturer's instructions and your local government's recycling or disposal directives.

Attention:

Il y a un risque d'explosion si la batterie est remplacée de façon incorrecte. Ne la remplacer qu'avec le même modèle ou équivalent recommandé par le constructeur. Recycler les batteries usées en accord avec les instructions du fabricant et les directives gouvernementales de recyclage.

产品中有毒有害物质或元素名称及含量

AAEON System

QO4-381 Rev.A0

部件名称	有毒有害物质或元素					
	铅 (Pb)	汞 (Hg)	镉 (Cd)	六价铬 (Cr(VI))	多溴联苯 (PBB)	多溴二苯 醚(PBDE)
印刷电路板 及其电子组件	×	○	○	○	○	○
外部信号 连接器及线材	×	○	○	○	○	○
外壳	○	○	○	○	○	○
中央处理器 与内存	×	○	○	○	○	○
硬盘	×	○	○	○	○	○
液晶模块	×	×	○	○	○	○
光驱	×	○	○	○	○	○
触控模块	×	○	○	○	○	○
电源	×	○	○	○	○	○
电池	×	○	○	○	○	○

本表格依据 SJ/T 11364 的规定编制。

○：表示该有毒有害物质在该部件所有均质材料中的含量均在 GB/T 26572 标准规定的限量要求以下。

×：表示该有害物质的某一均质材料超出了 GB/T 26572 的限量要求，然而该部件

仍符合欧盟指令 2011/65/EU 的规范。

备注：

- 一、此产品所标示之环保使用期限，系指在一般正常使用状况下。
- 二、上述部件物质中央处理器、内存、硬盘、光驱、电源为选购品。
- 三、上述部件物质液晶模块、触控模块仅一体机产品适用。

Hazardous and Toxic Materials List

AAEON System

QO4-381 Rev.A0

Component Name	Hazardous or Toxic Materials or Elements					
	Lead (Pb)	Mercury (Hg)	Cadmium (Cd)	Hexavalent Chromium (Cr(VI))	Polybrominated biphenyls (PBBS)	Polybrominated diphenyl ethers (PBDES)
PCB and Components	X	O	O	O	O	O
Wires & Connectors for Ext.Connections	X	O	O	O	O	O
Chassis	O	O	O	O	O	O
CPU & RAM	X	O	O	O	O	O
HDD Drive	X	O	O	O	O	O
LCD Module	X	X	O	O	O	O
Optical Drive	X	O	O	O	O	O
Touch Control Module	X	O	O	O	O	O
PSU	X	O	O	O	O	O
Battery	X	O	O	O	O	O

This form is prepared in compliance with the provisions of SJ/T 11364.

O: The level of toxic or hazardous materials present in this component and its parts is below the limit specified by GB/T 26572.

X: The level of toxic of hazardous materials present in the component exceed the limits specified by GB/T 26572, but is still in compliance with EU Directive 2011/65/EU (RoHS 2).

Notes:

1. The Environment Friendly Use Period indicated by labelling on this product is applicable only to use under normal conditions.
2. Individual components including the CPU, RAM/memory, HDD, optical drive, and PSU are optional.
3. LCD Module and Touch Control Module only applies to certain products which feature these components.

Table of Contents

- Chapter 1 - Product Specifications 1
 - 1.1 Specifications..... 2
- Chapter 2 – Hardware Information 4
 - 2.1 Dimensions 5
 - 2.2 System Port Pin Definition 7
 - 2.3 List of System Ports..... 8
 - 2.3.1 9 ~ 36V DC-In Port (3P(M) 5.0mm) (1) 9
 - 2.3.2 System On/Off (with Green LED) (2) 9
 - 2.3.3 COM 2 (RS-232/422/485) (3)..... 10
 - 2.3.4 COM 1 (RS-232/422/485) (4) 11
 - 2.3.5 Dual HDMI Port (5) 12
 - 2.3.6 Dual USB 3.2 Port (6) 14
 - 2.3.7 Dual USB 3.2/USB 2.0 Port (7)..... 15
 - 2.3.8 DIO Port (8)..... 16
 - 2.3.9 GbE RJ-45 LAN Port (9)..... 17
 - 2.3.10 2.5GbE RJ-45 LAN Port (10)..... 18
 - 2.3.11 Dual USB 2.0 Port (11) 19
 - 2.3.12 Audio Line-Out Port (3.5mm Stereo) (12) 20
 - 2.4 Main Board Jumpers and Connectors 21
 - 2.5 List of Jumpers 23
 - 2.5.1 Setting Jumpers 23
 - 2.5.2 Power Button Selection (JP4) 24
 - 2.5.3 Clear CMOS Jumper (JP2) 24
 - 2.6 Main Board List of Connectors 25
 - 2.6.1 Audio I/O Port (CN27)..... 27
 - 2.6.2 Dual HDMI Port (CN3) 28

2.6.3	Dual USB 3.2 Port (CN22).....	30
2.6.4	Dual USB 3.2/USB 2.0 Port (CN23).....	31
2.6.5	RJ-45 Connector (CN4/CN5).....	32
2.6.6	M.2 2280 M-Key (CN19).....	33
2.6.7	Remote Button Connector (CN48).....	35
2.6.8	M.2 3052 B-Key (CN20).....	35
2.6.9	Debug Card Connector (CN37).....	37
2.6.10	SATA Connector (CN11).....	38
2.6.11	SATA Power Connector (CN42).....	39
2.6.12	Digital IO Port (CN45).....	39
2.6.13	COM 1/COM 2 RS-232/422/485 Connector (CN40).....	40
2.6.14	COM 3/COM 4 RS-232/422/485 Connector (CN41).....	41
2.6.15	COM 1 RS-232/422/485 Box Connector (CN52).....	42
2.6.16	COM 2 RS-232/422/485 Box Connector (CN53).....	43
2.6.17	M.2 2230 E-Key (CN51).....	44
2.6.18	USB 2.0 Box Connector (5P Pitch:1.25mm) (CN46/CN47).....	46
2.7	DDR4 Module Installation.....	47
2.8	2.5" SATA Drive Installation.....	48
2.9	M.2 Module Installation.....	49
2.10	DIN Rail Mounting Instructions.....	50
Chapter 3 - AMI BIOS Setup.....		51
3.1	System Test and Initialization.....	52
3.2	AMI BIOS Setup.....	53
3.3	Setup Submenu: Main.....	54
3.4	Setup Submenu: Advanced.....	55
3.4.1	CPU Configuration.....	56
3.4.2	Memory Configuration.....	57
3.4.3	PCH-FW Configuration.....	58

3.4.3.1	Firmware Update Configuration.....	59
3.4.3.2	PTT Configuration	60
3.4.4	Hardware Monitor	61
3.4.5	Power Management.....	62
3.4.6	AAEON BIOS Robot.....	63
3.4.6.1	Device Detecting Configuration.....	65
3.4.7	AAEON Smart Boost.....	71
3.5	Setup Submenu: System I/O.....	72
3.5.1	Storage Configuration.....	73
3.5.2	HD Audio Configuration	74
3.5.3	Digital IO Port Configuration	75
3.5.4	Legacy Logical Devices Configuration.....	77
3.5.4.1	Serial Port 1	78
3.5.4.2	Serial Port 2	79
3.5.5	Serial Port Console Redirection	80
3.5.5.1	Console Redirection Settings (COM0)	81
3.5.5.2	Console Redirection Settings (Out-of-Band Mgmt Port).....	84
3.6	Setup Submenu: Security	86
3.6.1	Trusted Computing.....	87
3.6.2	Secure Boot	89
3.6.2.1	Key Management	90
3.7	Setup Submenu: Boot.....	92
3.7.1	UEFI BBS Priorities	93
3.8	Setup Submenu: Save & Exit	94
3.9	Setup Submenu: MEBx.....	95
Chapter 4	– Drivers Installation	96
4.1	Drivers Download and Installation.....	97

Appendix A – I/O Information 99

 A.1 I/O Address Map 100

 A.2 Memory Address Map 101

 A.3 IRQ Mapping Chart 102

Chapter 1

Product Specifications

1.1 Specifications

System

CPU	12th Generation Intel® Core™ Processors: Intel® Core™ i7-1265UE Intel® Core™ i5-1245UE Intel® Core™ i3-1215UE
Chipset	Intel® SoC
System Memory	DDR4 SODIMM x 1, up to 32GB
Display Interface	HDMI 1.4b (Type-A) x 2
Storage Device	2.5" SATA III Drive Bay x 1 M.2 2280 M-Key x 1 (PCIe [x4])
Ethernet	RJ-45 x 1 for Intel® I226-LM, 2.5GbE RJ-45 x 1 for Intel® I219-LM, GbE
I/O	USB 3.2 Gen 2 (Type-A) x 3 USB 2.0 (Type-A) x 3 DB-9 x 2 for RS-232/422/485 DB-15 x 1 for DIO 8-bit HDMI 1.4b (Type-A) x 2 Audio x 1 for Line-Out Power Button x 1 3-pin Terminal Block for DC-in x 1 Antenna Opening x 4
Expansion	M.2 2230 E-Key x 1 (Wi-Fi/BT) M.2 3052 B-Key w/ SIM x 1 (LTE/5G) M.2 2280 M-Key x 1 (NVMe)
Indicator	Power Button with LED x 1

System

OS Support	Windows® 10 IoT Enterprise LTSC
	Windows® 11 Pro
	Ubuntu 22.04

Power Supply

Power Requirement	DC 9V ~ 36V with 3-pin Terminal Block
--------------------------	---------------------------------------

Mechanical

Mounting	DIN Rail Mount
	Wallmount (Optional)
Dimensions (W x H x D)	2.93" x 7.32" x 5.0" (74.3mm x 186mm x 127mm)
Gross Weight	5.3 lb. (2.41Kg)
Net Weight	3.9 lb. (1.77Kg)

Environmental

Operating Temperature	-4°F ~140°F (-20°C ~ 60°C), IEC68-2 with 0.5 m/s AirFlow
Storage Temperature	-40°F ~ 176°F (-40°C ~ 80°C)
Storage Humidity	5 ~ 95% @40°C, non-condensing
Anti-Vibration	With SSD: Random, 3 Grms, 5~500Hz
Anti-Shock	With SSD: 50G, IEC 60068-2-27, half sine, 11ms duration
Certification	CE/FCC Class A

Chapter 2

Hardware Information

2.1 Dimensions

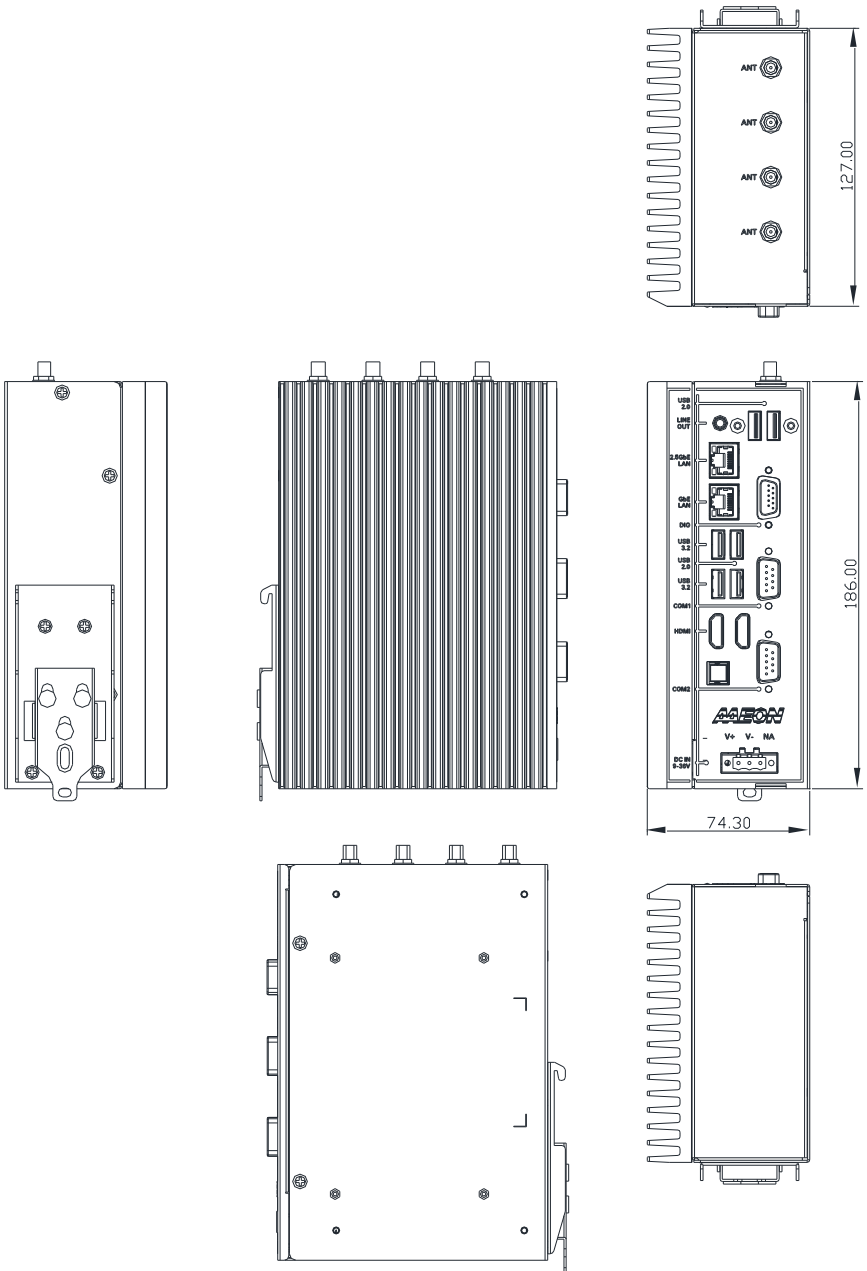

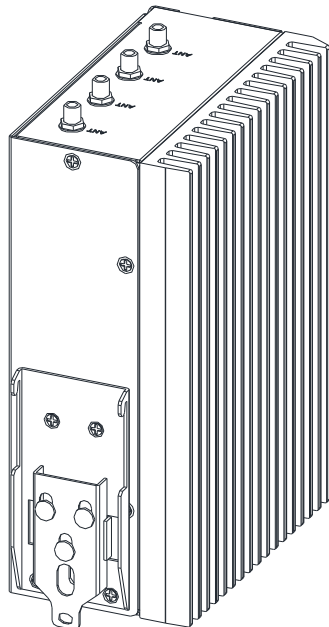
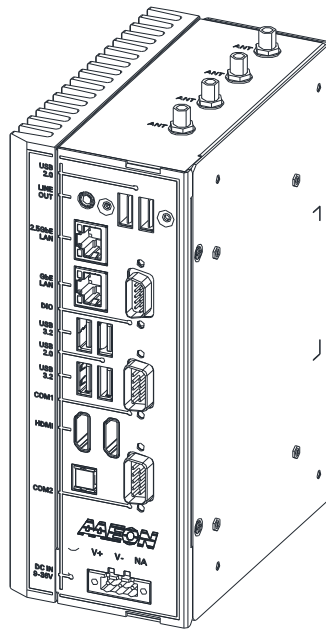

2.2 System Port Pin Definition

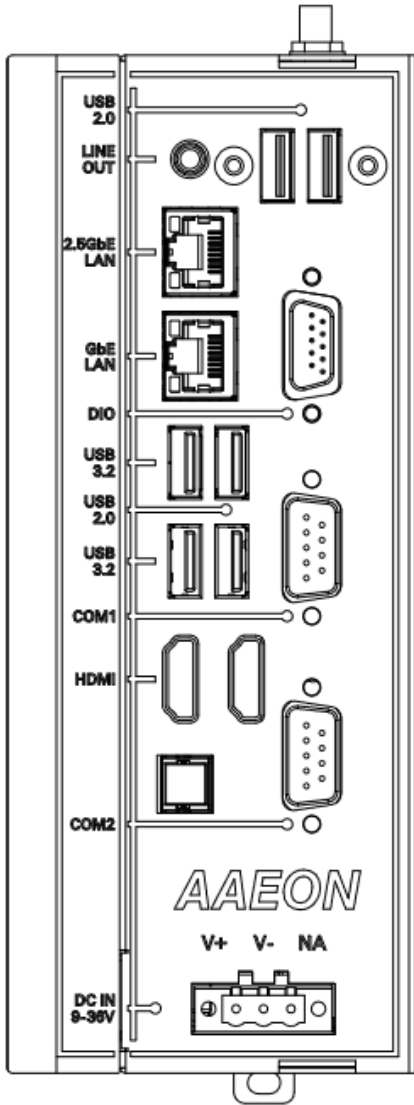

2.3 List of System Ports

Please refer to the table below for all of the system's ports that you can configure for your application

Label	Function
1	9~36V DC-In
2	System On/Off (with Green LED)
3	COM 2 (RS-232/422/485)
4	COM 1 (RS-232/422/485)
5	Dual HDMI Port
6	Dual USB 3.2 Port
7	Dual USB 3.2/USB 2.0 Port
8	DIO Port
9	GbE RJ-45 LAN Port
10	2.5GbE RJ-45 LAN Port
11	Dual USB 2.0 Port
12	Audio Line Out Port

2.3.1 9 ~ 36V DC-In Port (3P(M) 5.0mm) (1)

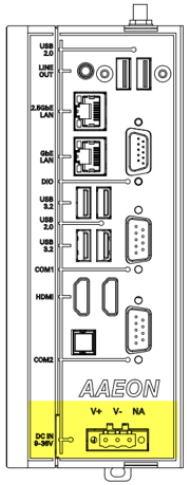

2.3.2 System On/Off (with Green LED) (2)

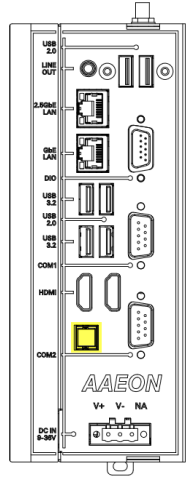

2.3.3 COM 2 (RS-232/422/485) (3)

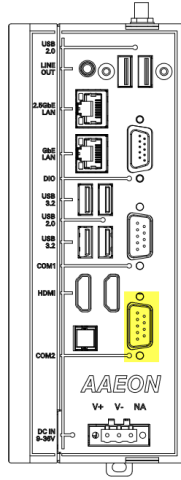

Pin	Pin Name	Signal Type	RS-422	RS-485
1	DCD2	IN	RS422_TX-	RS485_D-
2	RX2	IN	RS422_TX+	RS485_D+
3	TX2	OUT	RS422_RX+	
4	DTR2	OUT	RS422_RX-	
5	GND	GND		
6	DSR2	IN		
7	RTS2	OUT		
8	CTS2	IN		
9	RI1	IN		

2.3.4 COM 1 (RS-232/422/485) (4)

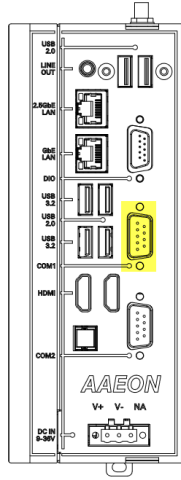

Pin	Pin Name	Signal Type	RS-422	RS-485
1	DCD1	IN	RS422_TX-	RS485_D-
2	RX1	IN	RS422_TX+	RS485_D+
3	TX1	OUT	RS422_RX+	
4	DTR1	OUT	RS422_RX-	
5	GND	GND		
6	DSR1	IN		
7	RTS1	OUT		
8	CTS1	IN		
9	RI1	IN		

2.3.5 Dual HDMI Port (5)

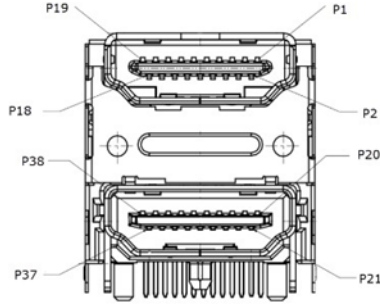
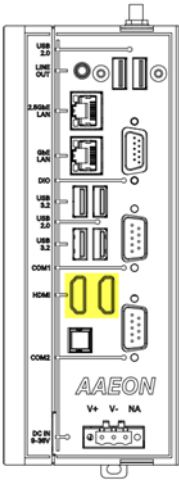

Pin	Signal	Signal Type	Signal Level
P1	HDMI1_DATA2_P	DIFF	
P2	GND	GND	
P3	HDMI1_DATA2_N	DIFF	
P4	HDMI1_DATA1_P	DIFF	
P5	GND	GND	
P6	HDMI1_DATA1_N	DIFF	
P7	HDMI1_DATA0_P		
P8	GND	GND	
P9	HDMI1_DATA0_n		
P10	HDMI1_CLK_P	DIFF	
P11	GND	GND	
P12	HDMI1_CLK_N	DIFF	
P13	CEC		+3.3V
P14	NC	GND	
P15	HDMI1_SCL	PWR	

Pin	Signal	Signal Type	Signal Level
P16	HDMI1_SDA		
P17	GND		
P18	+V5S_HDMI_CON	GND	+5V
P19	HDMI1_HPD		+5V
P20	HDMI2_DATA2_P		
P21	GND	GND	
P22	HDMI2_DATA2_N		
P23	HDMI2_DATA1_P		
P24	GND	GND	
P25	HDMI2_DATA1_N		
P26	HDMI2_DATA0_P		
P27	GND	GND	
P28	HDMI2_DATA0_N		
P29	HDMI2_CLK_P		
P30	GND		
P31	HDMI2_CLK_N		
P32	CEC		+3.3V
P33	NC	GND	
P34	HDMI2_SCL		
P35	HDMI2_SDA		
P36	GND		
P37	+V5S_HDMI_CON		+5V
P38	HDMI2_HPD		+5V

2.3.6 Dual USB 3.2 Port (6)

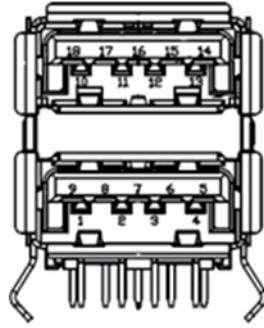
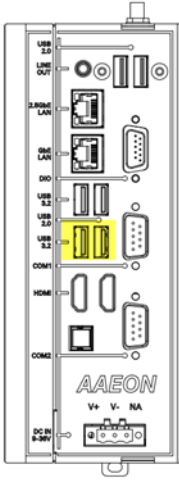

Pin	Signal	Signal Type	Signal Level
1	+5VSB	PWR	+5V
2	USB_D-	DIFF	
3	USB_D+	DIFF	
4	GND	GND	
5	USB3_RX_N	DIFF	
6	USB3_RX_P	DIFF	
7	GND	GND	
8	USB3_TX_N	DIFF	
9	USB3_TX_P	DIFF	
10	+5VSB	PWR	+5V
11	USB_D-	DIFF	
12	USB_D+	DIFF	
13	GND	GND	
14	USB3_RX_N	DIFF	
15	USB3_RX_P	DIFF	

Pin	Signal	Signal Type	Signal Level
16	GND	GND	
17	USB3_TX_N	DIFF	
18	USB3_TX_P	DIFF	

2.3.7 Dual USB 3.2/USB 2.0 Port (7)

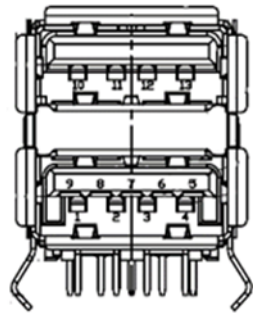
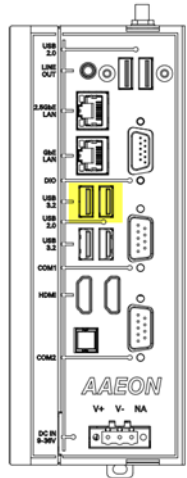

Pin	Signal	Signal Type	Signal Level
1	+5VSB	PWR	+5V
2	USB_D-	DIFF	
3	USB_D+	DIFF	
4	GND	GND	
5	USB3_RX_N	DIFF	
6	USB3_RX_P	DIFF	
7	GND	GND	
8	USB3_TX_N	DIFF	
9	USB3_TX_P	DIFF	
10	+5VSB	PWR	+5V
11	USB_D-	DIFF	

Pin	Signal	Signal Type	Signal Level
12	USB_D+	DIFF	
13	GND	GND	

2.3.8 DIO Port (8)

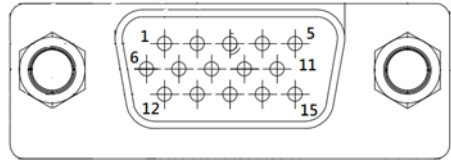
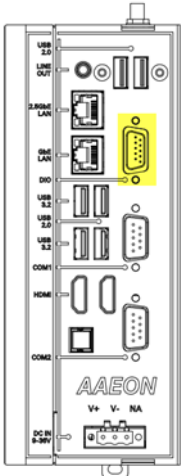

Pin	Signal	Signal Type	Signal Level
1	DIO0	I/O	+5V
2	DIO1	I/O	+5V
3	DIO2	I/O	+5V
4	DIO3	I/O	+5V
5	DIO4	I/O	+5V
6	DIO5	I/O	+5V
7	DIO6	I/O	+5V
8	DIO7	I/O	+5V
9	+5V	PWR	+5V
10	GND	GND	
11	NC		
12	NC		

Pin	Signal	Signal Type	Signal Level
13	NC		
14	NC		
15	NC		

2.3.9 GbE RJ-45 LAN Port (9)

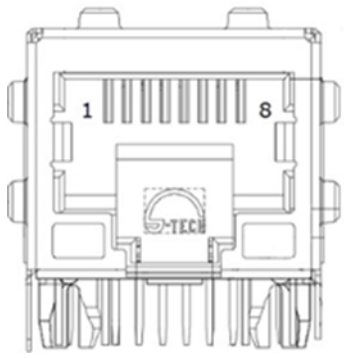
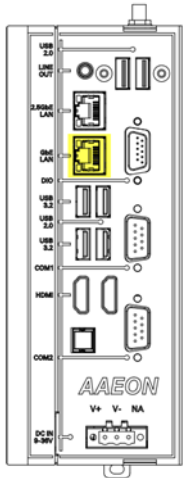

Pin	Signal	Signal Type
1	MDI0+	DIFF
2	MDI0-	DIFF
3	MDI1+	DIFF
4	MDI2+	DIFF
5	MDI2-	DIFF
6	MDI1-	DIFF
7	MDI3+	DIFF
8	MDI3-	DIFF

2.3.10 2.5GbE RJ-45 LAN Port (10)

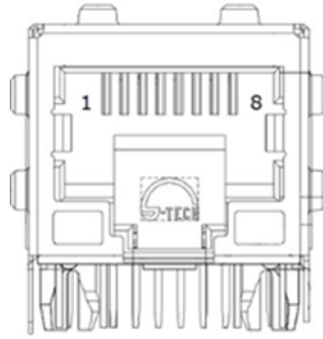
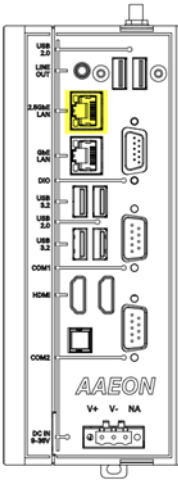

Pin	Signal	Signal Type
1	MDI0+	DIFF
2	MDI0-	DIFF
3	MDI1+	DIFF
4	MDI2+	DIFF
5	MDI2-	DIFF
6	MDI1-	DIFF
7	MDI3+	DIFF
8	MDI3-	DIFF

2.3.11 Dual USB 2.0 Port (11)

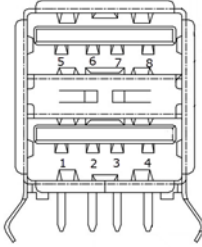
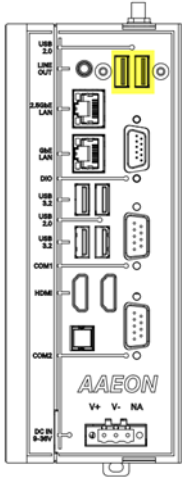

Pin	Signal	Signal Type	Signal Level
1	+5VSB	PWR	+5V
2	USB_D-	DIFF	
3	USB_D+	DIFF	
4	GND	GND	
5	+5VSB	PWR	+5V
6	USB_D-	DIFF	
7	USB_D+	DIFF	
8	GND	GND	

2.3.12 Audio Line-Out Port (3.5mm Stereo) (12)

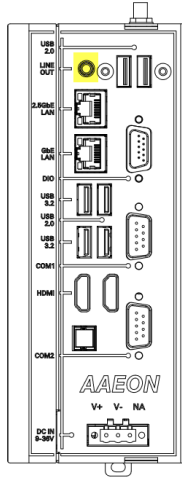

2.4 Main Board Jumpers and Connectors

Component Side

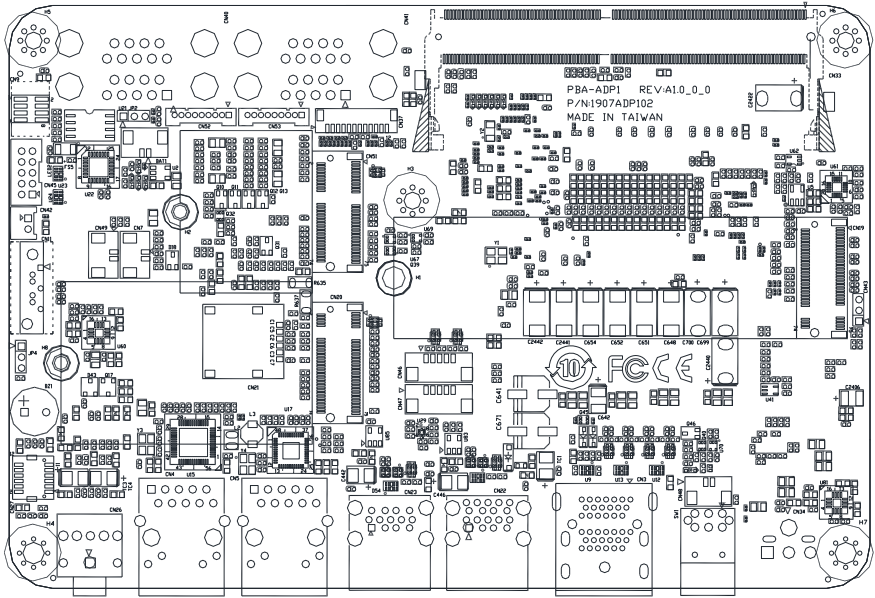

Solder Side

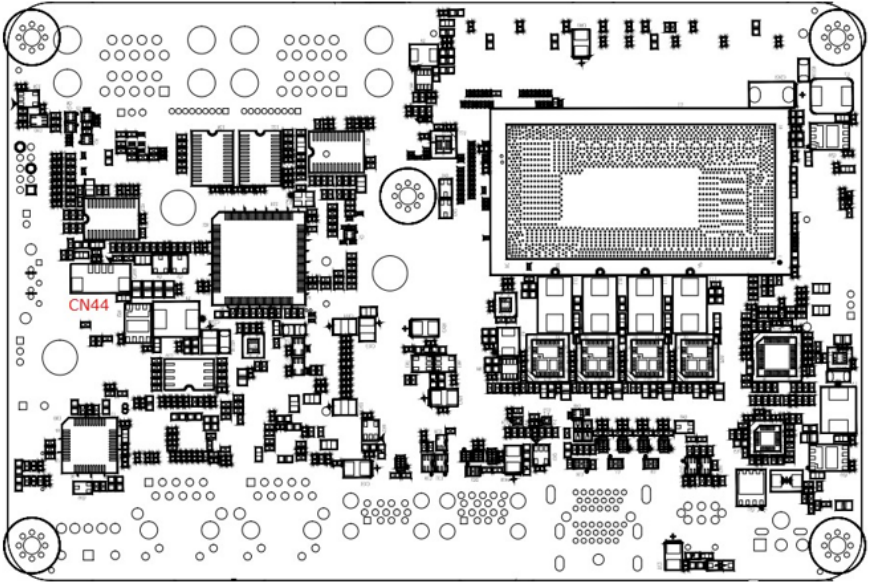

2.5 List of Jumpers

Please refer to the table below for all of the system's jumpers that you can configure for your application.

Label	Function
JP4	Power Button Selection (ATX/AT)
JP2	CMOS Control Selection

2.5.1 Setting Jumpers

The BOXER-6751-ADP comes with several jumpers which allow you to configure the system by either setting the jumper to "open" or "closed"; or by selecting certain pins. A closed jumper has two pins connected with a jumper clip, while an open jumper has no pins connected.

For jumpers with multiple pins, this guide uses "pins A-B" to notate which pins should be connected by a jumper clip. For example, "pins 1-2" means you should connect pins 1 and 2, while "pins 2-3" means you should connect pins 2 and 3.

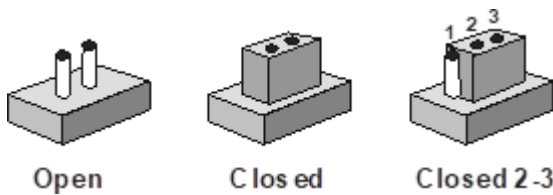

A pair of needle-nose pliers may be helpful when working with jumpers.

If you have any questions about how best to configure the system for your application, contact your AAEON representative or visit our website to talk with our support team.

2.5.2 Power Button Selection (JP4)

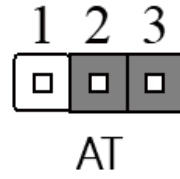
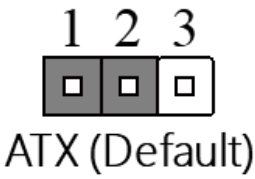

2.5.3 Clear CMOS Jumper (JP2)

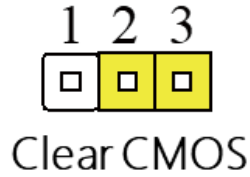
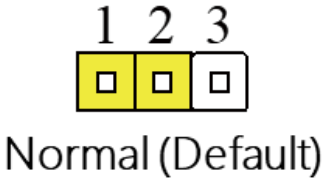

2.6 Main Board List of Connectors

Please refer to the table below for all of the system's connectors that you can configure for your application

Label	Function
CN33	SODIMM Channel A
CN3	Dual HDMI Port
CN4	RJ-45 Connector
CN5	RJ-45 Connector
CN51	M.2 2230 E-Key
CN19	M.2 2280 M-Key
CN20	M.2 3052 B-Key
CN21	SIM Slot (B-Key)
CN48	Remote Button Connector
CN37	Debug Card Connector (ESPI bus)
CN11	SATA Connector
CN42	SATA Power Connector
CN45	DIO Connector
CN40	COM 1/COM 2 RS-232/RS-422/RS-485 Connector
CN41	COM 3/COM 4 RS-232/RS-422/RS-485 Connector
CN52	COM 1 RS-232/RS-422/RS-485 Box Connector
CN53	COM 2 RS-232/RS-422/RS-485 Box Connector
CN22	Dual USB 3.2 Connector
CN23	Dual USB 3.2/USB 2.0
CN46	USB 2.0 Box Connector
CN47	USB 2.0 Box Connector
CN26	Audio Line Out

Label	Function
CN27	Audio
CN34	Power Input
SW1	Power Button w/ LED
BAT1	RTC Connector
CN7	Reset Switch
CN49	PS_ON Connector

2.6.1 Audio I/O Port (CN27)

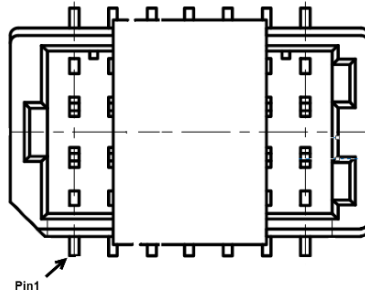

Pin	Signal	Signal Type	Signal Level
1	LINE_OUT_R	OUT	
2	MIC_R	IN	
3	LINE_OUT_L	OUT	
4	MIC_L	IN	
5	HPOUT-JD	IN	
6	MIC-JD	IN	
7	AUD_GND	GND	
8	AUD_GND	GND	
9	LINE_IN_JD	IN	
10	LINE_IN_R	IN	
11	+VDD_AUD	PWR	+5V
12	LINE_IN_L	IN	
13	AUD_GND	GND	
14	AUD_GND	GND	

2.6.2 Dual HDMI Port (CN3)

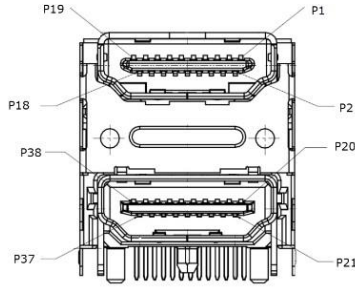

Pin	Signal	Signal Type	Signal Level
P1	HDMI1_DATA2_P	DIFF	
P2	GND	GND	
P3	HDMI1_DATA2_N	DIFF	
P4	HDMI1_DATA1_P	DIFF	
P5	GND	GND	
P6	HDMI1_DATA1_N	DIFF	
P7	HDMI1_DATA0_P		
P8	GND	GND	
P9	HDMI1_DATA0_n		
P10	HDMI1_CLK_P	DIFF	
P11	GND	GND	
P12	HDMI1_CLK_N	DIFF	
P13	CEC		+3.3V
P14	NC		
P15	HDMI1_SCL		
P16	HDMI1_SDA		
P17	GND	GND	
P18	+V5S_HDMI_CON	PWR	+5V
P19	HDMI1_HPD		+5V

Pin	Signal	Signal Type	Signal Level
P20	HDMI2_DATA2_P		
P21	GND	GND	
P22	HDMI2_DATA2_N		
P23	HDMI2_DATA1_P		
P24	GND	GND	
P25	HDMI2_DATA1_N		
P26	HDMI2_DATA0_P		
P27	GND	GND	
P28	HDMI2_DATA0_N		
P29	HDMI2_CLK_P		
P30	GND	GND	
P31	HDMI2_CLK_N		
P32	CEC		+3.3V
P33	NC		
P34	HDMI2_SCL		
P35	HDMI2_SDA		
P36	GND	GND	
P37	+V55_HDMI_CON		+5V
P38	HDMI2_HPD		+5V

2.6.3 Dual USB 3.2 Port (CN22)

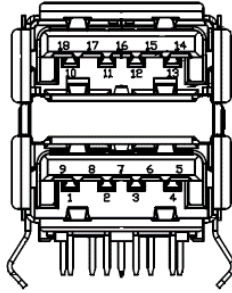

Pin	Signal	Signal Type	Signal Level
1	+5VSB	PWR	+5V
2	USB_D-	DIFF	
3	USB_D+	DIFF	
4	GND	GND	
5	USB3_RX_N	DIFF	
6	USB3_RX_P	DIFF	
7	GND	GND	
8	USB3_TX_N	DIFF	
9	USB3_TX_P	DIFF	
10	+5VSB	PWR	+5V
11	USB_D-	DIFF	
12	USB_D+	DIFF	
13	GND	GND	
14	USB3_RX_N	DIFF	
15	USB3_RX_P	DIFF	
16	GND	GND	
17	USB3_TX_N	DIFF	
18	USB3_TX_P	DIFF	

2.6.4 Dual USB 3.2/USB 2.0 Port (CN23)

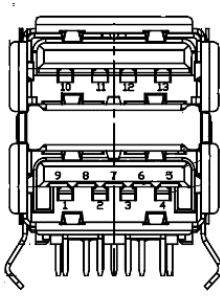

Pin	Signal	Signal Type	Signal Level
1	+5VSB	PWR	+5V
2	USB_D-	DIFF	
3	USB_D+	DIFF	
4	GND	GND	
5	USB3_RX_N	DIFF	
6	USB3_RX_P	DIFF	
7	GND	GND	
8	USB3_TX_N	DIFF	
9	USB3_TX_P	DIFF	
10	+5VSB	PWR	+5V
11	USB_D-	DIFF	
12	USB_D+	DIFF	
13	GND	GND	

2.6.5 RJ-45 Connector (CN4/CN5)

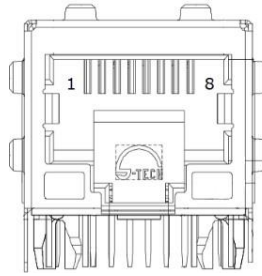

Pin	Signal	Signal Type
1	MDI0+	DIFF
2	MDI0-	DIFF
3	MDI1+	DIFF
4	MDI2+	DIFF
5	MDI2-	DIFF
6	MDI1-	DIFF
7	MDI3+	DIFF
8	MDI3-	DIFF

2.6.6 M.2 2280 M-Key (CN19)

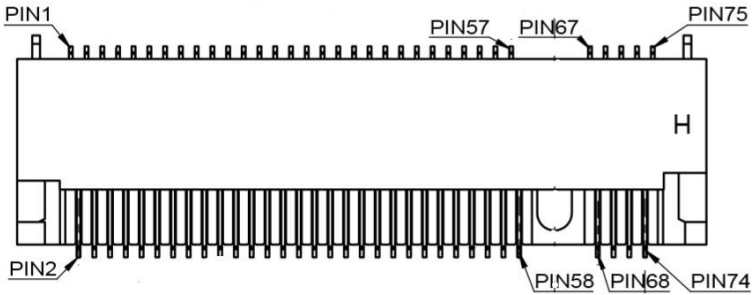

Pin	Pin Name	Signal Type	Pin	Pin Name	Signal Type	Signal Level
1	GND	GND	2	+3.3V	PWR	+3.3V
3	GND	GND	4	+3.3V	PWR	+3.3V
5	PCIE_RXN0	IN	6	CARD_PWR_OFF_N	OUT	+3.3V
7	PCIE_RXP0	IN	8	NC		
9	GND	GND	10	NC		
11	PCIE_TXN0	OUT	12	+3.3V	PWR	+3.3V
13	PCIE_TXP0	OUT	14	+3.3V	PWR	+3.3V
15	GND	PWR	16	+3.3V	PWR	+3.3V
17	PCIE_RXN1	IN	18	+3.3V	PWR	+3.3V
19	PCIE_RXP1	IN	20	NC		
21	GND	PWR	22	NC		
23	PCIE_TXN1	OUT	24	NC		
25	PCIE_TXP1	OUT	26	NC		
27	GND	PWR	28	NC		
29	PCIE_RXN2	IN	30	NC		
31	PCIE_RXP2	IN	32	NC		
33	GND	GND	34	NC		

Pin	Pin Name	Signal Type	Pin	Pin Name	Signal Type	Signal Level
35	PCIE_TXN2	OUT	36	NC		
37	PCIE_TXP2	OUT	38	DEVSLP	IN	+3.3V
39	GND	GND	40	SMB_CLK_M2		+1.8V
41	PCIE_RXP3	IN	42	SMB_DATA_M2		+1.8V
43	PCIE_RXN3	IN	44	NC		
45	GND	GND	46	NC		
47	PCIE_TXN3	OUT	48	NC		
49	PCIE_TXP3	OUT	50	RESET#	IN	+3.3V
51	GND	PWR	52	CLKREQ#	OUT	+3.3V
53	PCIE_M.2_CLK#	OUT	54	WAKE#	OUT	+3.3V
55	PCIE_M.2_CLK	OUT	56	NC		
57	GND	GND	58	NC		
67	NC		68	NC		
69	NC		70	+3.3V	PWR	+3.3V
71	GND	GND	72	+3.3V	PWR	+3.3V
73	GND	GND	74	+3.3V	PWR	+3.3V
75	GND	GND				

2.6.7 Remote Button Connector (CN48)

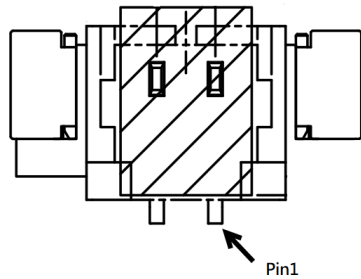

Pin	Signal	Signal Type
1	PWR_BUTTON	IN
2	GND	GND

2.6.8 M.2 3052 B-Key (CN20)

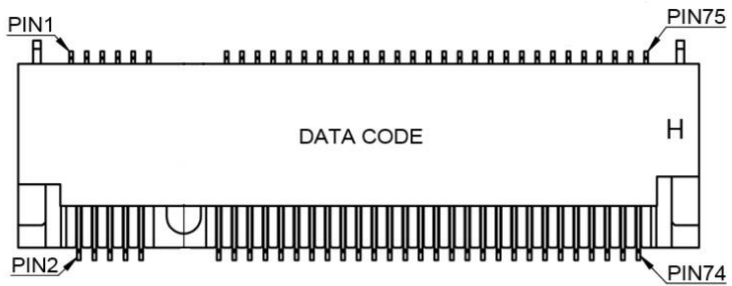

Pin	Pin Name	Signal Type	Pin	Pin Name	Signal Type	Signal Level
1	NC		2	+3.3V	PWR	+3.3V
3	GND	GND	4	+3.3V	PWR	+3.3V
5	GND	GND	6	CARD_PWR_OFF_N	OUT	+3.3V
7	USB_2.0_P		8	W_DISABLE	IN	+3.3V
9	USB_2.0_N		10	NC		

Pin	Pin Name	Signal Type	Pin	Pin Name	Signal Type	Signal Level
11	GND	GND	12			
			20	NC		
21	NC		22	NC		
23	NC		24	NC		
25	NC		26	NC		
27	GND	GND	28	NC		
29	USB3_RXN		30	UIM_RST		
31	USB3_RXP		32	UIM_CLK		
33	GND	GND	34	UIM_DATA		
35	USB3_TXN		36	UIM_PWR		
37	USB3_TXP		38	NC		
39	GND	GND	40	NC		
41	PCIE_RXN		42	NC		
43	PCIE_RXP		44	NC		
45	GND	GND	46	NC		
47	PCIE_TXN		48	NC		
49	PCIE_TXP		50	RESET#	IN	+3.3V
51	GND	PWR	52	CLKREQ#	OUT	+3.3V
53	PCIE_M.2_CLK#	OUT	54	WAKE#	OUT	+3.3V
55	PCIE_M.2_CLK	OUT	56	NC		
57	GND	GND	58	NC		
59	NC		60	NC		
61	NC		62	NC		
63	NC		64	NC		

Pin	Pin Name	Signal Type	Pin	Pin Name	Signal Type	Signal Level
65	NC		66	NC		
67	RESET#		68	SUSCLK		
69	NC		70	+3.3V	PWR	+3.3V
71	GND	GND	72	+3.3V	PWR	+3.3V
73	GND	GND	74	+3.3V	PWR	+3.3V
75	GND	GND				

2.6.9 Debug Card Connector (CN37)

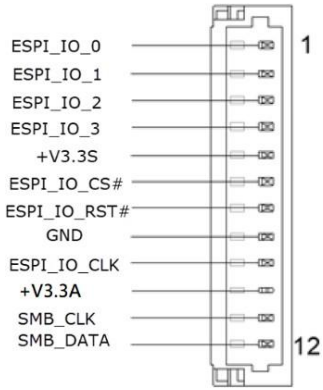

Pin	Signal	Signal Type	Signal Level
1	ESPI_IO_0	I/O	+1.8V
2	ESPI_IO_1	I/O	+1.8V
3	ESPI_IO_2	I/O	+1.8V
4	ESPI_IO_3	I/O	+1.8V
5	+3.3V	PWR	+3.3V
6	ESPI_IO_CS#	IN	
7	ESPI_IO_RST#	IN	
8	GND	GND	

Pin	Signal	Signal Type	Signal Level
9	EPSI_IO_LCLK	IN	
10	SMCLK	IN	
11	SMDAT	I/O	
12	NC		

2.6.10 SATA Connector (CN11)

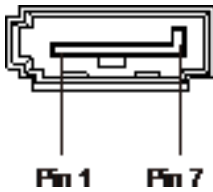

Pin	Signal	Signal Type
1	GND	GND
2	SATA_TX+	DIFF
3	SATA_TX-	DIFF
4	GND	GND
5	SATA_RX-	DIFF
6	SATA_RX+	DIFF
7	GND	GND

2.6.11 SATA Power Connector (CN42)

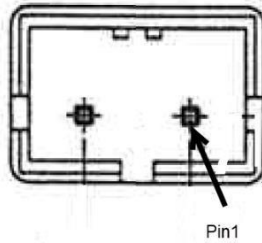

Pin	Signal	Signal Type	Signal Level
1	+5VS	PWR	+5V
2	GND	GND	

2.6.12 Digital IO Port (CN45)

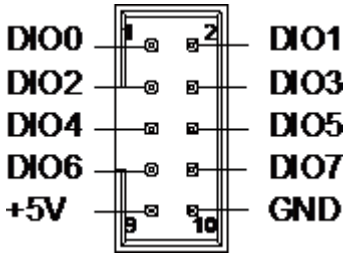

Pin	Signal	Signal Type	Signal Level
1	DIO0	I/O	+5V
2	DIO1	I/O	+5V
3	DIO2	I/O	+5V
4	DIO3	I/O	+5V
5	DIO4	I/O	+5V
6	DIO5	I/O	+5V
7	DIO6	I/O	+5V
8	DIO7	I/O	+5V

Pin	Signal	Signal Type	Signal Level
9	+5V	PWR	+5V
10	GND	GND	

2.6.13 COM 1/COM 2 RS-232/422/485 Connector (CN40)

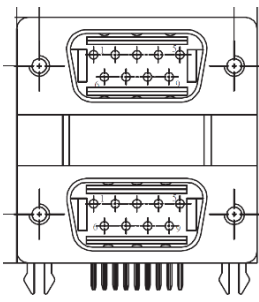

Pin	Pin Name	Signal Type	RS-422	RS-485
1	DCD1	IN	RS422_TX-	RS485_D-
6	DSR1	IN		
2	RX1	IN	RS422_TX+	RS485_D+
7	RTS1	OUT		
3	TX1	OUT	RS422_RX+	
8	CTS1	IN		
4	DTR1	OUT	RS422_RX-	
9	RI1	IN		
5	GND	GND		
10	DCD2	IN	RS422_TX-	RS485_D-
15	DSR2	IN		
11	RX2	IN	RS422_TX+	RS485_D+
16	RTS2	OUT		

Pin	Pin Name	Signal Type	RS-422	RS-485
12	TX2	OUT	RS422_RX+	
17	CTS2	IN		
13	DTR2	OUT	RS422_RX-	
18	RI2	IN		
14	GND	GND		

2.6.14 COM 3/COM 4 RS-232/422/485 Connector (CN41)

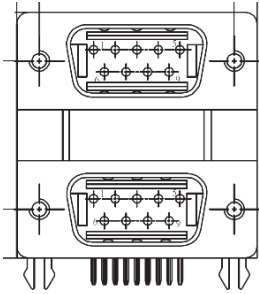

Pin	Pin Name	Signal Type	RS-422	RS-485
1	DCD3	IN	RS422_TX-	RS485_D-
6	DSR3	IN		
2	RX3	IN	RS422_TX+	RS485_D+
7	RTS3	OUT		
3	TX3	OUT	RS422_RX+	
8	CTS3	IN		
4	DTR3	OUT	RS422_RX-	
9	RI3	IN		
5	GND	GND		
10	DCD4	IN	RS422_TX-	RS485_D-
15	DSR4	IN		

Pin	Pin Name	Signal Type	RS-422	RS-485
11	RX4	IN	RS422_TX+	RS485_D+
16	RTS4	OUT		
12	TX4	OUT	RS422_RX+	
17	CTS4	IN		
13	DTR4	OUT	RS422_RX-	
18	RI4	IN		
14	GND	GND		

2.6.15 COM 1 RS-232/422/485 Box Connector (CN52)

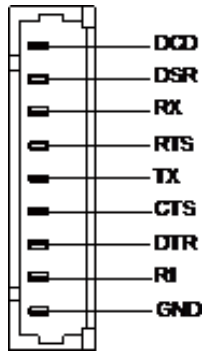

Pin	Pin Name	Signal Type	RS-422	RS-485
1	DCD1	IN	RS422_TX-	RS485_D-
2	DSR1	IN		
3	RX1	IN	RS422_TX+	RS485_D+
4	RTS1	OUT		
5	TX1	OUT	RS422_RX+	
6	CTS1	IN		
7	DTR1	OUT	RS422_RX-	

Pin	Pin Name	Signal Type	RS-422	RS-485
8	RI1	IN		
9	GND	GND		

2.6.16 COM 2 RS-232/422/485 Box Connector (CN53)

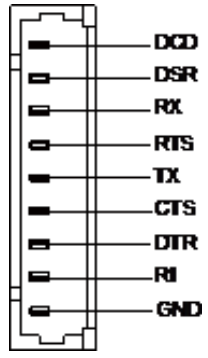

Pin	Pin Name	Signal Type	RS-422	RS-485
1	DCD2	IN	RS422_TX-	RS485_D-
2	DSR2	IN		
3	RX2	IN	RS422_TX+	RS485_D+
4	RTS2	OUT		
5	TX2	OUT	RS422_RX+	
6	CTS2	IN		
7	DTR2	OUT	RS422_RX-	
8	RI2	IN		
9	GND	GND		

2.6.17 M.2 2230 E-Key (CN51)

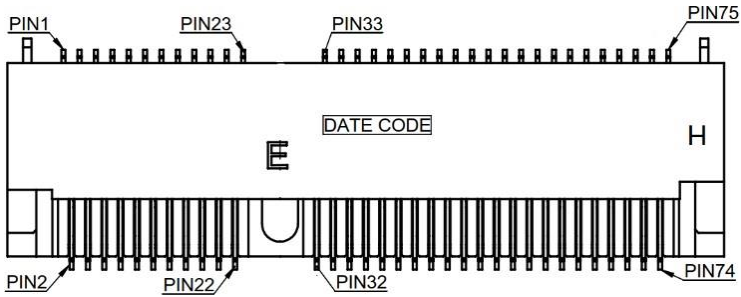

Pin	Pin Name	Signal Type	Pin	Pin Name	Signal Type	Signal Level
1	GND	GND	2	+3.3V	PWR	+3.3V
3	USB_2.0_P	DIFF	4	+3.3V	PWR	+3.3V
5	USB_2.0_N	DIFF	6	NC		
7	GND	GND	8	NC		
9	NC		10	NC		
11	NC		12	NC		
13	NC		14	NC		
15	NC		16	NC		
17	NC		18	GND	GND	
19	NC		20	NC		
21	NC		22	NC		
23	NC					
			32	NC		
33	GND	GND	34	NC		

Pin	Pin Name	Signal Type	Pin	Pin Name	Signal Type	Signal Level
35	PCIE_TXP	DIFF	36	NC		
37	PCIE_TXN	DIFF	38	NC		
39	GND	GND	40	NC		
41	PCIE_RXP	DIFF	42	NC		
43	PCIE_RXN	DIFF	44	NC		
45	GND	GND	46	NC		
47	PCIE_CLK	DIFF	48	NC		
49	PCIE_CLK#	DIFF	50	SUSCLK		
51	GND		52	PLT_RESET#		
53	PCIE_CLKREQ#		54	BT_DIS#		
55	PCIE_WAKE#		56	WLAK_DIS#		
57	GND	GND	58	NC		
59	NC		60	NC		
61	NC		62	NC		
63	GND	GND	64	NC		
65	NC		66	NC		
67	NC		68	NC		
69	GND	GND	70	+3.3V	PWR	+3.3V
71	NC		72	+3.3V	PWR	+3.3V
73	NC		74	+3.3V	PWR	+3.3V
75	GND	GND				

2.6.18 USB 2.0 Box Connector (5P Pitch:1.25mm) (CN46/CN47)

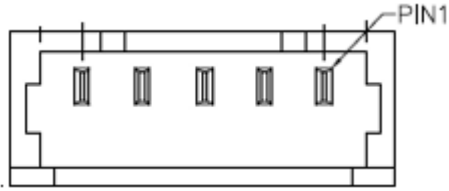

Pin	Signal	Signal Type	Signal Level
1	+5V	GND	+5V
2	USBD-	DIFF	
3	USBD+	DIFF	
4	GND	GND	
5	GND	GND	

2.7 DDR4 Module Installation

Before installing the DDR4 module, ensure the system is powered down and disconnect the power cord from the system. Make sure you have the module ready to install.

Step 1: Remove the three (3) M3 screws from the bottom of the chassis as shown, then remove the bottom panel from the system.

Step 2: Insert the DDR4 module into the slot, followed by a thermal pad underneath the DIMM heatsink.

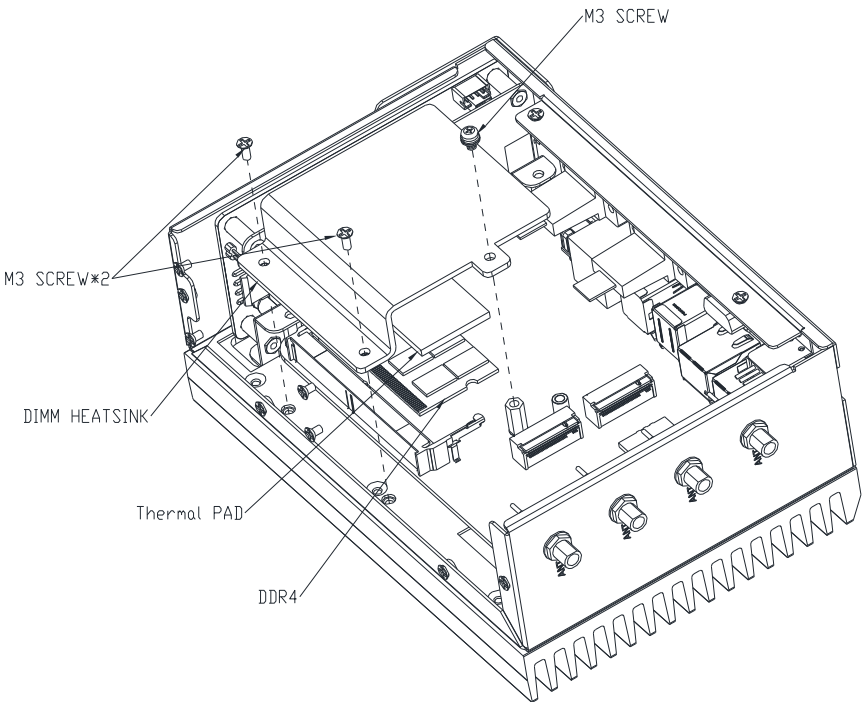

2.8 2.5" SATA Drive Installation

Before installing the SATA Drive, ensure the system is powered down and disconnect the power cord from the system. Make sure you have the SATA Drive ready to install.

Step 1: Remove the four (4) screws from the bottom of the chassis to remove the bottom panel from the system.

Step 2: Attach the SATA drive to the HDD Bracket using the screws provided.

Step 3: Attach the HDD Bracket to the bottom panel using four (4) M3 screws as shown in the figure below, then attach the SATA and SATA Power cables to the board and the SATA drive.

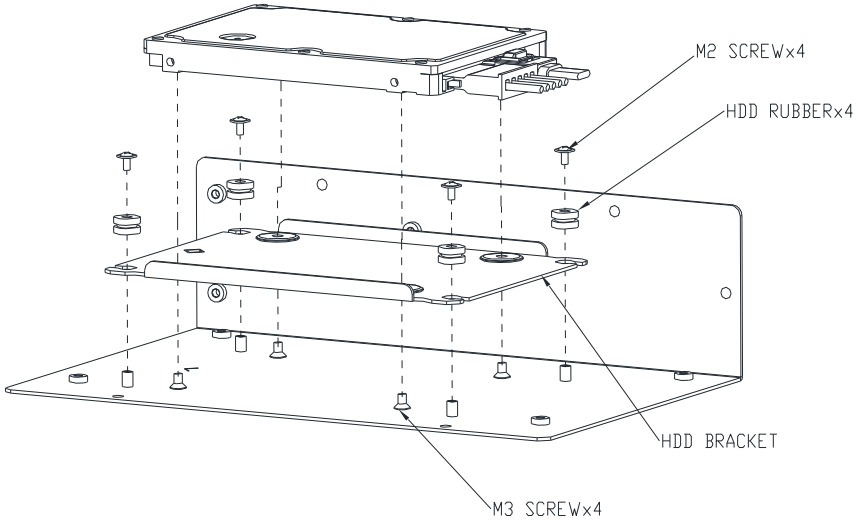

Step 4: Use the four (4) M2 screws provided to assemble 2.5" SATA drive with the HDD Bracket, being sure to place the four (4) HDD dampers between the screws and HDD bracket

2.9 M.2 Module Installation

The M.2 2230 E-Key, M.2 2280 M-Key, and M.2 3052 B-Key slots are accessible by removing the bottom panel.

Follow standard procedures for expansion card installation, aligning the notch on each M.2 SSD with its respective key slot.

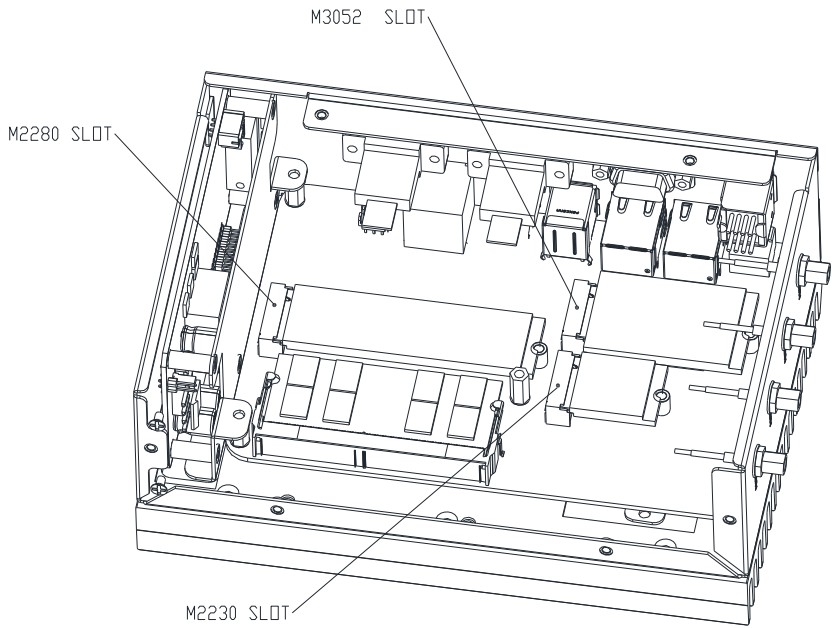

2.10 DIN Rail Mounting Instructions

For DIN Rail mounting, affix the chassis to the DIN rail using the four (4) M3 screws provided, as shown.

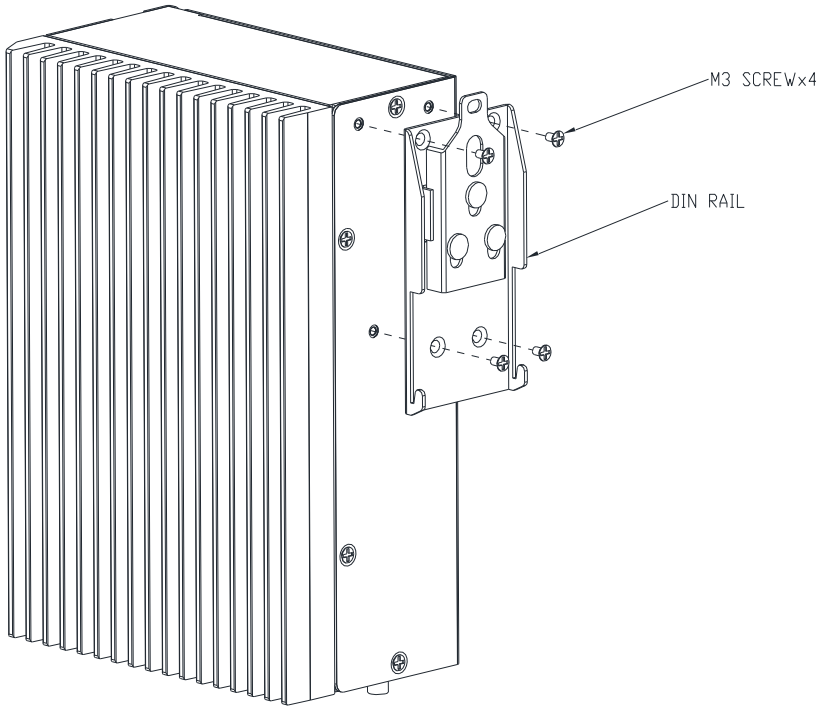

Chapter 3

AMI BIOS Setup

3.1 System Test and Initialization

The system uses certain routines to perform testing and initialization. If an error, fatal or non-fatal, is encountered, a few short beeps or an error message will be outputted. The board can usually continue the boot up sequence with non-fatal errors.

The system configuration verification routines check the current system configuration against the values stored in the CMOS memory. If they do not match, an error message will be outputted, in which case you will need to run the BIOS setup program to set the configuration information in memory.

There are three situations in which you will need to change the CMOS settings:

- You are starting your system for the first time
- You have changed your system's hardware
- The CMOS memory has lost power and the configuration information is erased

The system's CMOS memory uses a backup battery for data retention, which is to be replaced once emptied.

3.2 AMI BIOS Setup

The AMI BIOS ROM has a pre-installed Setup program that allows users to modify basic system configurations, which is stored in the battery-backed CMOS RAM and BIOS NVRAM so that the information is retained when the power is turned off.

To enter BIOS Setup, press or <F2> immediately while your computer is powering up.

The function for each interface can be found below.

Main – Date and time can be set here. Press <Tab> to switch between date elements

Advanced – Enable/ Disable boot option for legacy network devices

System I/O – Enable/ Disable system I/O device

Security – The setup administrator password can be set here

Boot – Enable/ Disable quiet Boot Option

Save & Exit – Save your changes and exit the program

MEBx – Intel® Management Engine BIOS Extension

3.3 Setup Submenu: Main

Aptio Setup - AMI

Main Advanced System I/O Security Boot Save & Exit MEBx

== BIOS Information == BOXER-6751-ADP R1.2 (B751AM12)(05/02/2023)		Set the Date. Use Tab to switch between Date elements. Default Ranges: Year: 1998-2199 Months: 1-12 Days: dependent on month
== CPU Information == 12th Gen Intel(R) Core(TM) i7-1265UE		
== MEM Information == Total Memory 8192 MB Memory Frequency 2133 MHz		
== SATA Information == Serial ATA Port 1 TS128GSSD370I (128.0GB)		
System Date	[Sat 07/29/2023]	+/: Select Screen ↑↓: Select Item Enter: Select +/-: Change Opt. F1: General Help F2: Previous Values F3: Optimized Defaults F4: Save & Exit ESC: Exit
System Time	[20:15:21]	
Access Level	Administrator	

Version 2.22.1286 Copyright (C) 2023 AMI

3.4 Setup Submenu: Advanced

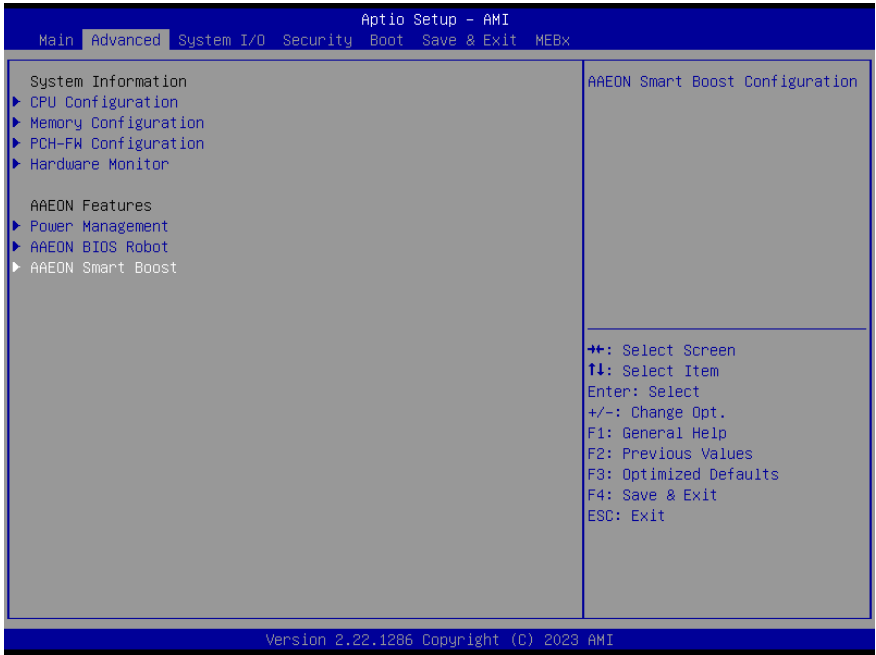

3.4.1 CPU Configuration

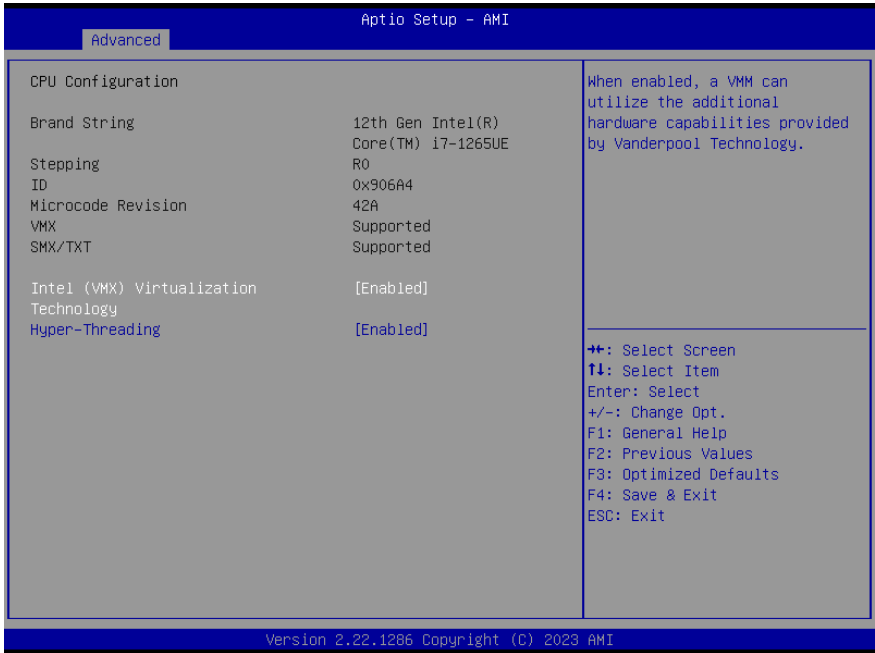

Options Summary		
Intel (VMX) Virtualization Technology	Disabled	
	Enabled	Optimal Default, Failsafe Default
When enabled, a VMM can utilize the additional hardware capabilities provided by Vanderpool Technology.		
Hyper-Threading	Disabled	
	Enabled	Optimal Default, Failsafe Default
Enable or Disable Hyper-Threading Technology.		

3.4.2 Memory Configuration

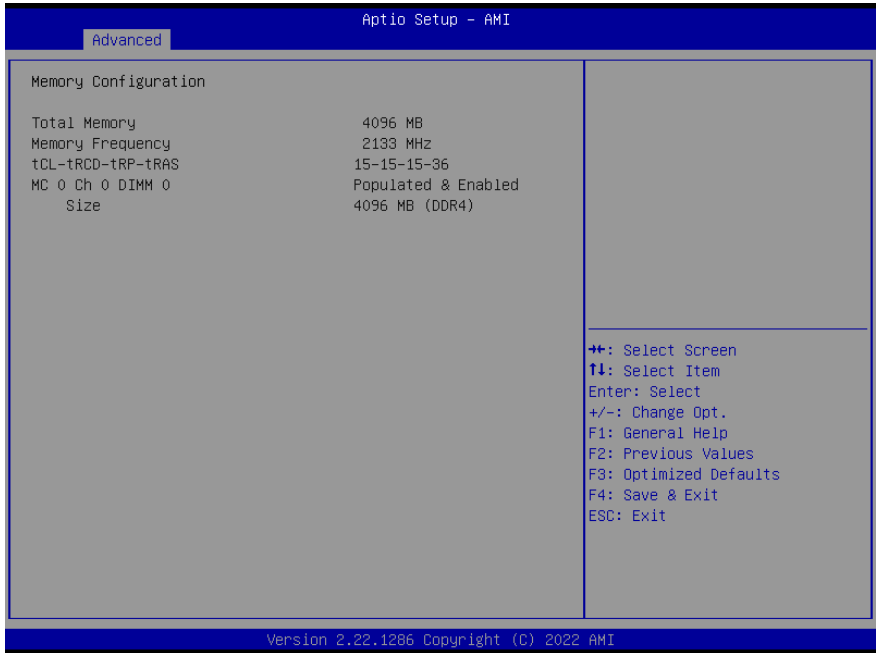

3.4.3 PCH-FW Configuration

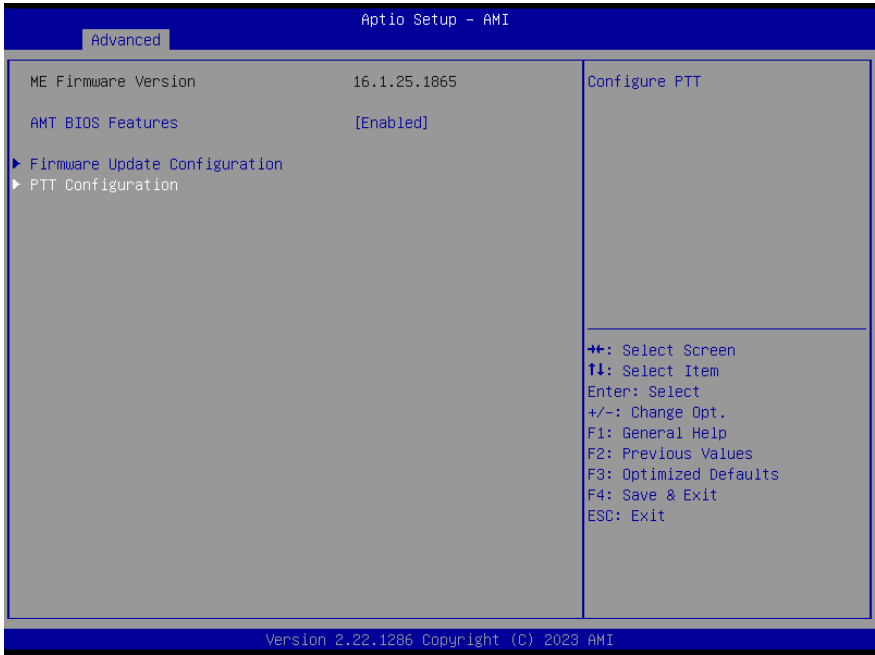

Options Summary		
AMT BIOS Features	Enabled	Optimal Default, Failsafe Default
	Disabled	
<p>When disabled AMT BIOS Features are no longer supported and user is no longer able to access MEBx Setup.</p> <p>Note: This option does not disable Manageability Features in FW.</p>		

3.4.3.1 Firmware Update Configuration

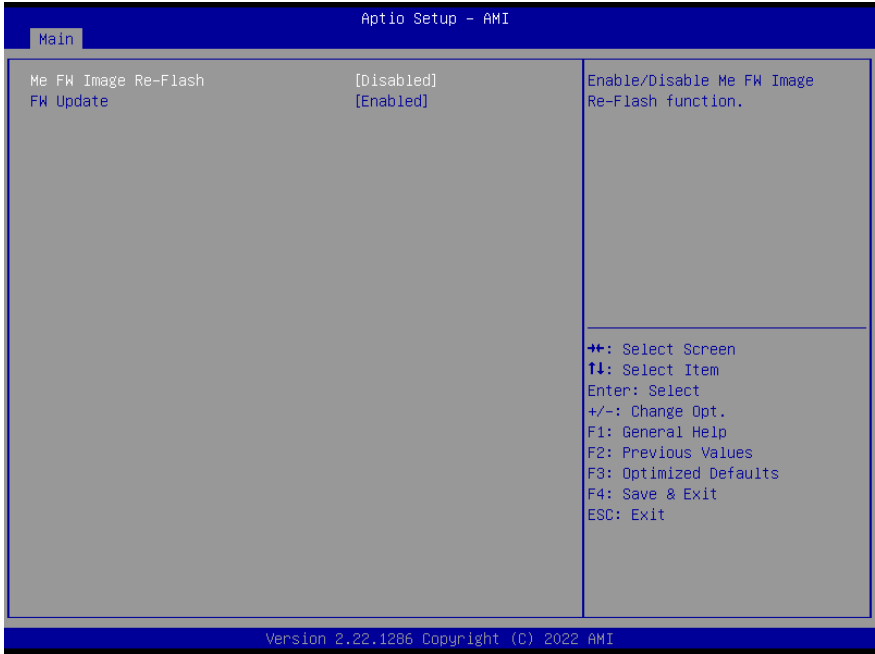

Options Summary		
Me FW Image Re-Flash	Enabled	
	Disabled	Optimal Default, Failsafe Default
Enable/ Disable Me FW Image Re-Flash function.		
FW Update	Enabled	
	Disabled	Optimal Default, Failsafe Default
Enable/ Disable Me FW Update function.		

3.4.3.2 PTT Configuration



Options Summary		
Me FW Image Re-Flash	PTT	
	dTPM	Optimal Default, Failsafe Default
<p>Selects TPM device: PTT or dTPM. PTT - Enables PTT in SkuMgr. dTPM 1.2 - Disables PTT in SkuMgr. Warning! PTT/dTPM will be disabled and all data saved on it will be lost.</p>		

3.4.4 Hardware Monitor

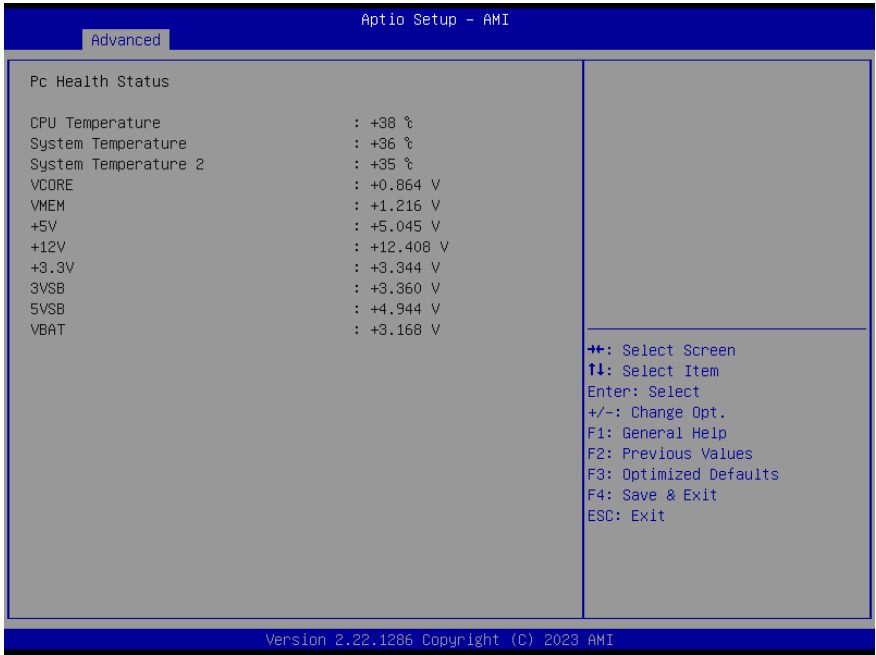

3.4.5 Power Management

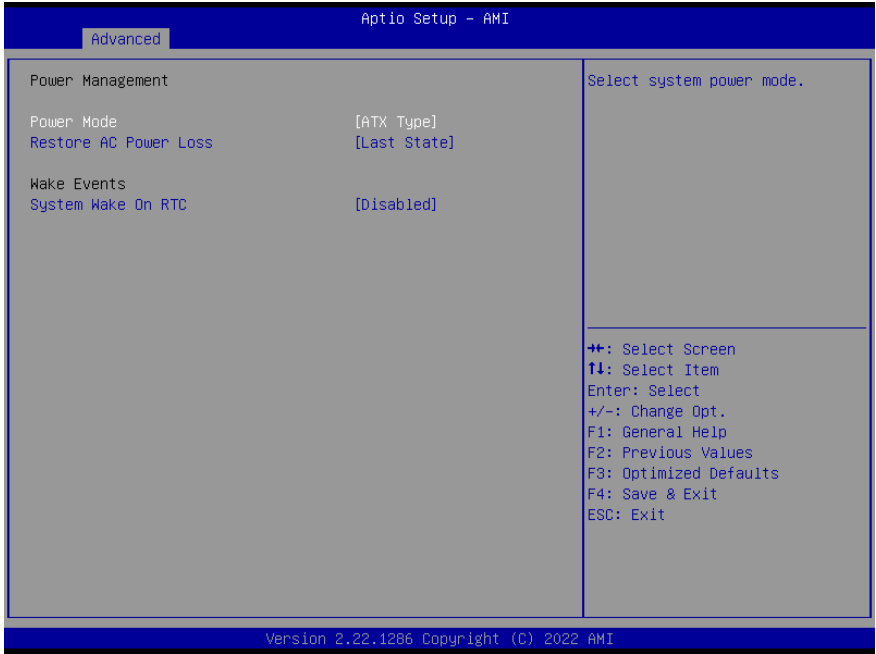

Options Summary		
Power Mode	ATX Type	Optimal Default, Failsafe Default
	AT Type	
Select system power mode		
Restore AC Power Loss	Last State	Optimal Default, Failsafe Default
	Always On	
	Always Off	
Set GPI [3:0] Output as Hi or Low		
System Wake On RTC	Disabled	Optimal Default, Failsafe Default
	By Date	
	By Weekday	
	Bypass	
By Date: System will wake on the day with hr::min::sec specified.		
By Weekday: System will wake on the enabled weekday with hr::min::sec specified.		
Bypass: BIOS will not control RTC wake function.		

3.4.6 AAEON BIOS Robot

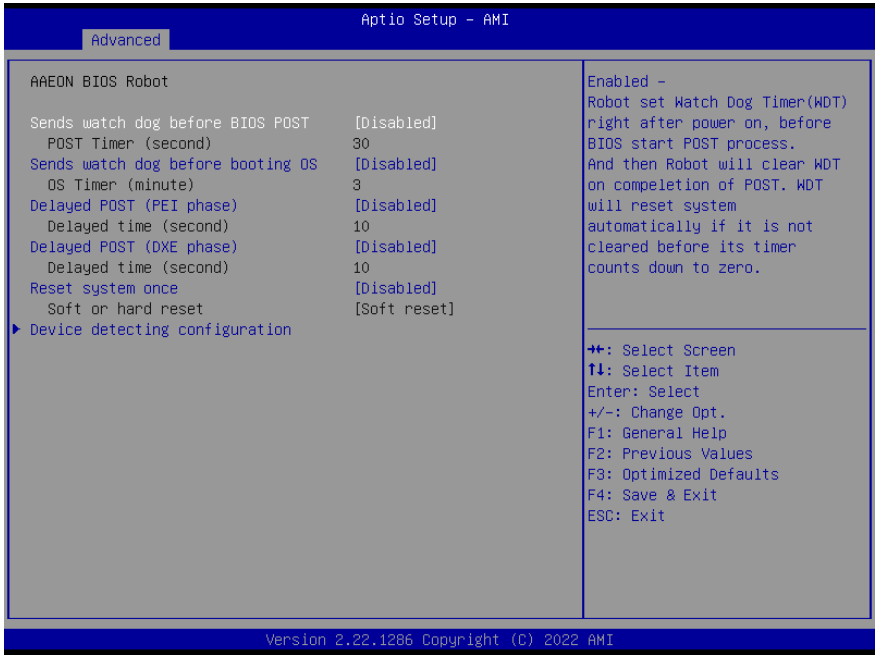

Options Summary		
Sends watch dog before BIOS POST	Disabled	Optimal Default, Failsafe Default
	Enabled	
Enabled – Robot set Watch Dog Timer (WDT) right after power on, before BIOS start POST process. And then Robot will clear WDT on completion of POST. WDT on completion of POST. WDT will reset system automatically if it is not cleared before its timer counts down to zero.		
Sends watch dog before booting OS	Disabled	Optimal Default, Failsafe Default
	Enabled	
Enabled – Robot set Watch Dog Timer (WDT) after POST completion, before BIOS transfer control to OS. WARNING: Before enabling this function, a program in OS must be in responsible for clearing WDT. Also, this function should be disabled if OS is going to update itself.		
Delayed POST (PEI phase)	Disabled	Optimal Default, Failsafe Default
	Enabled	

Options Summary		
Enabled - Robot holds BIOS from starting POST, right after power on. This allows BIOS POST to start with stable power or start after system is physically warmed-up. Note: Robot does this before 'Sends watch dog'.		
Delayed POST (DXE phase)	Disabled	Optimal Default, Failsafe Default
	Enabled	
Enabled - Robot holds BIOS before POST completion. This allows BIOS POST to start with stable power or start after system is physically warmed-up. Note: Robot does this after 'Sends watch dog before BIOS POST'.		

3.4.6.1 Device Detecting Configuration

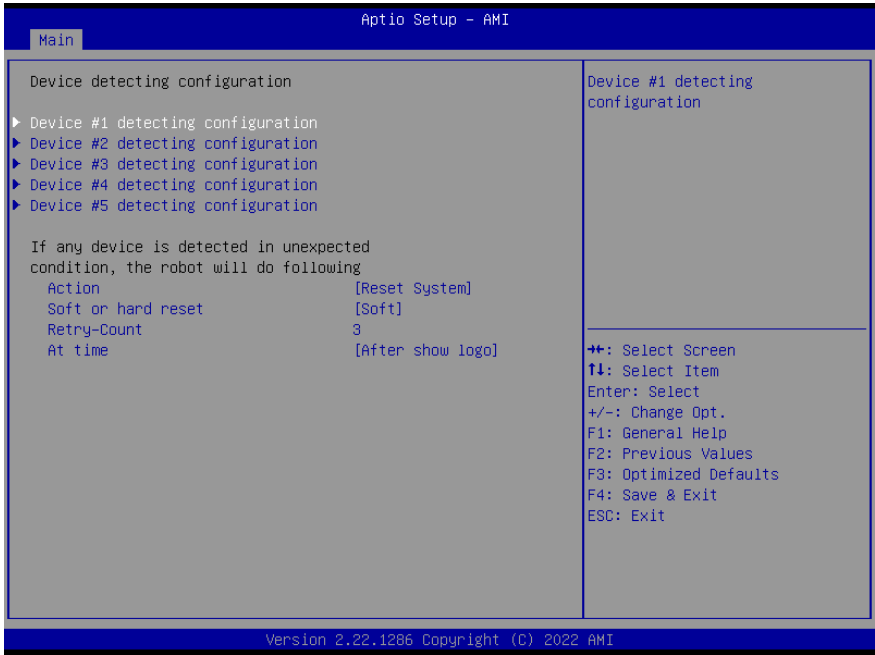

Options Summary		
Action	Reset System	Optimal Default, Failsafe Default
	Hold System	
Select action that robot should do.		
Soft or hard reset	Soft	Optimal Default, Failsafe Default
	Hard	
Select reset type robot should send on each boot.		
Retry-Count	3	Optimal Default, Failsafe Default
Fill retry counter here. Robot will reset system at most counter times, and then let system continue its POST.		
At time	After show logo	Optimal Default, Failsafe Default
	Before show logo	
Select robot action time: After show logo -Robot will do action after logo is displayed. System devices are almost ready. Before show logo - Robot will do action earlier before logo, but some devices may not be ready.		

3.4.6.1.1 Device #1 Detecting Configuration

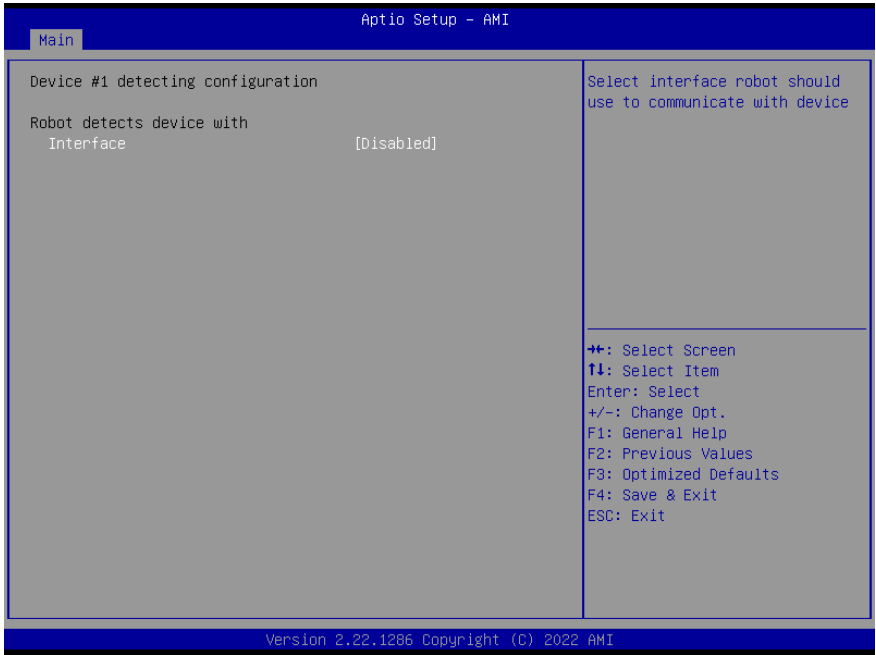

Options Summary		
Interface	Disabled	Optimal Default, Failsafe Default
	PCI	
	DIO	
	SMBUS	
	Legacy I/O	
	Super I/O	
	MMIO	
Select interface robot should use to communicate with device.		

3.4.6.1.2 Device #2 Detecting Configuration

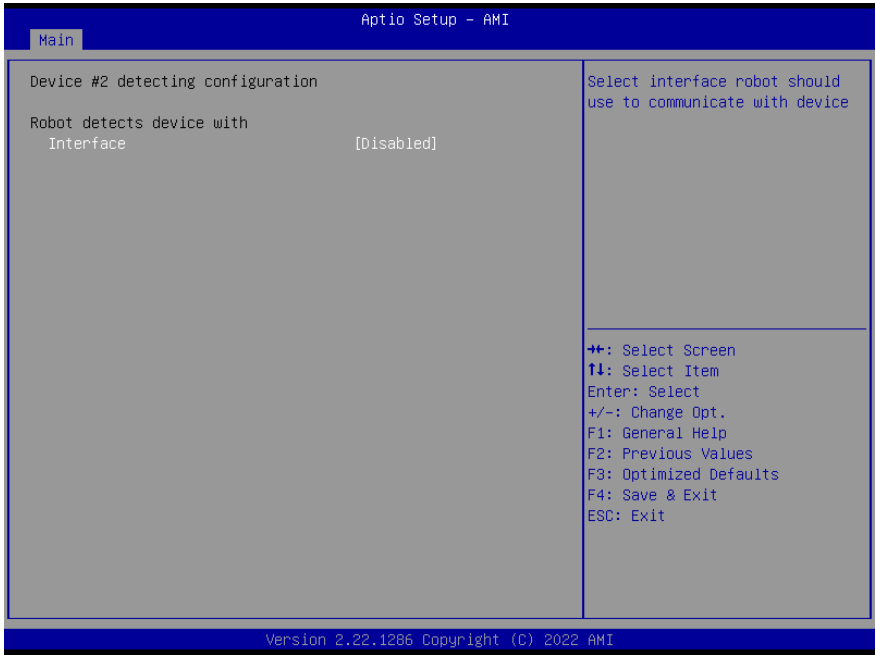

Options Summary		
Interface	Disabled	Optimal Default, Failsafe Default
	PCI	
	DIO	
	SMBUS	
	Legacy I/O	
	Super I/O	
	MMIO	
Select interface robot should use to communicate with device.		

3.4.6.1.3 Device #3 Detecting Configuration

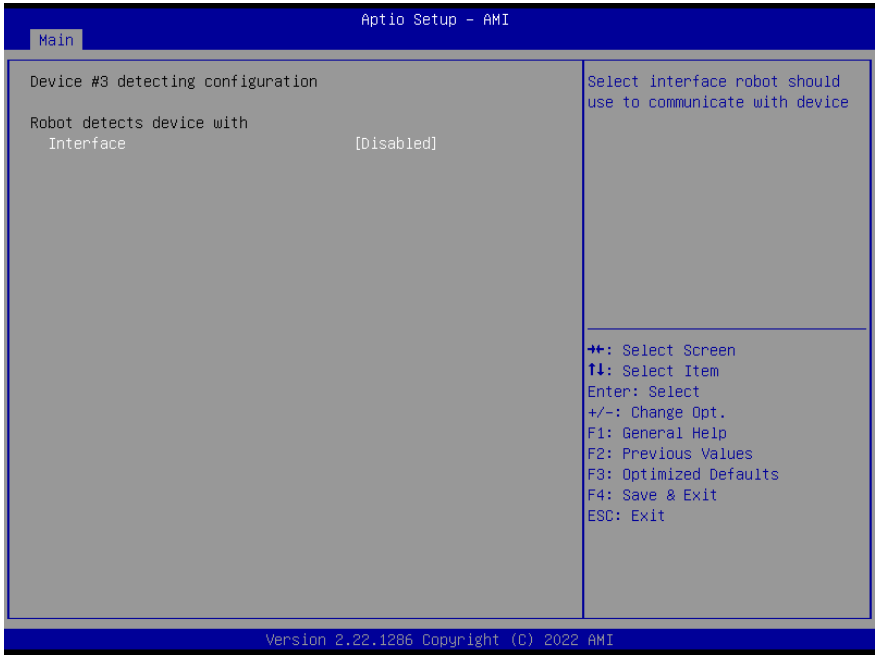

Options Summary		
Interface	Disabled	Optimal Default, Failsafe Default
	PCI	
	DIO	
	SMBUS	
	Legacy I/O	
	Super I/O	
	MMIO	
Select interface robot should use to communicate with device.		

3.4.6.1.4 Device #4 Detecting Configuration

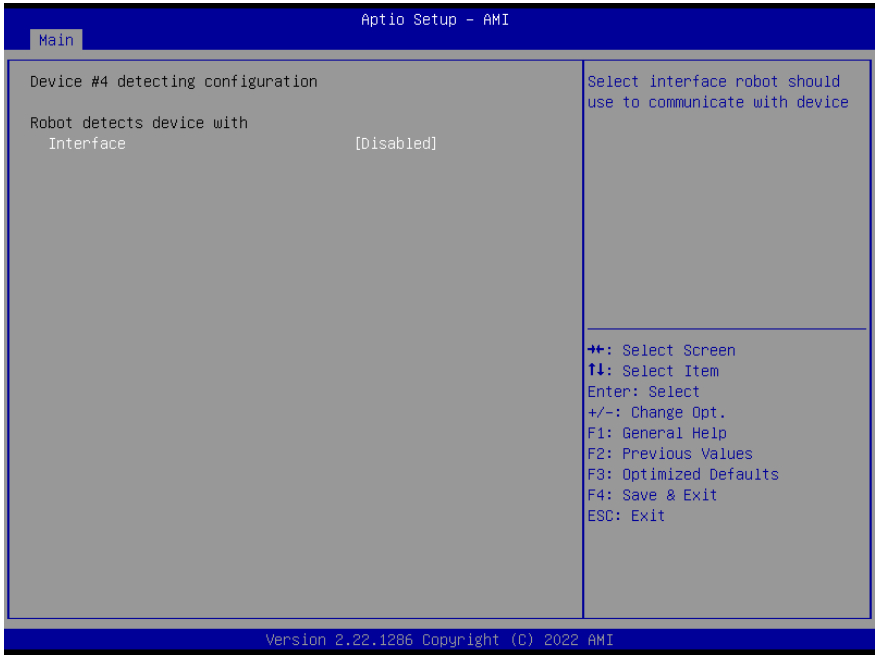

Options Summary		
Interface	Disabled	Optimal Default, Failsafe Default
	PCI	
	DIO	
	SMBUS	
	Legacy I/O	
	Super I/O	
	MMIO	
Select interface robot should use to communicate with device.		

3.4.6.1.5 Device #5 Detecting Configuration

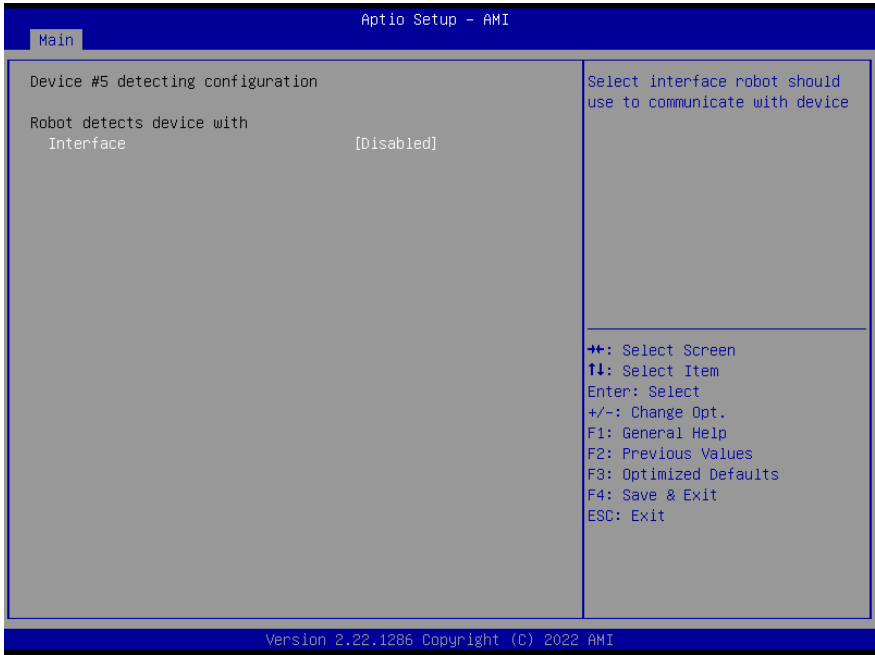

Options Summary		
Interface	Disabled	Optimal Default, Failsafe Default
	PCI	
	DIO	
	SMBUS	
	Legacy I/O	
	Super I/O	
	MMIO	
Select interface robot should use to communicate with device.		

3.4.7 AAEON Smart Boost

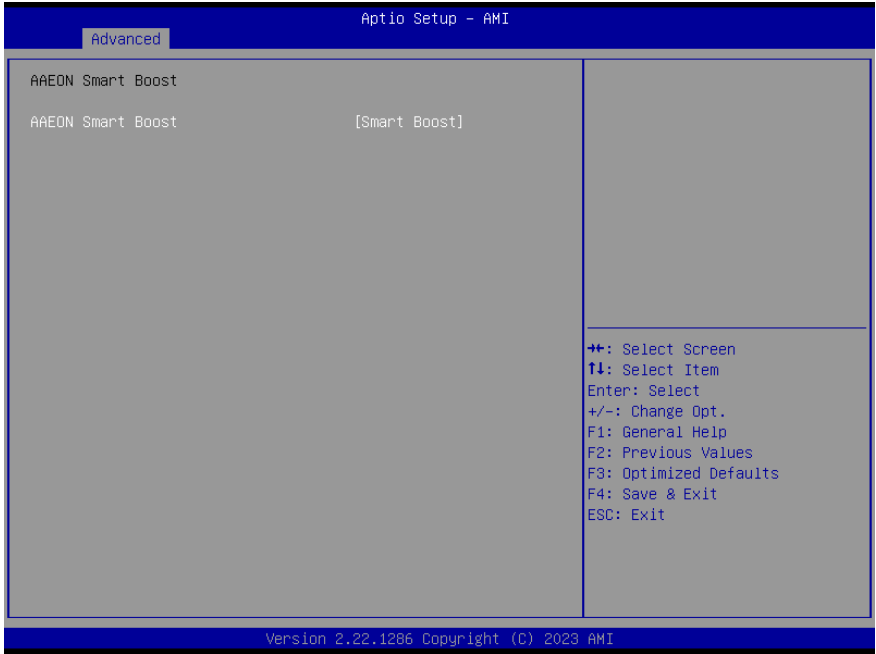

Options Summary		
AAEON Smart Boost	Smart Boost	Optimal Default, Failsafe Default
	Maximum Performance	
	Good Stability	
	Disable	

3.5 Setup Submenu: System I/O



3.5.1 Storage Configuration

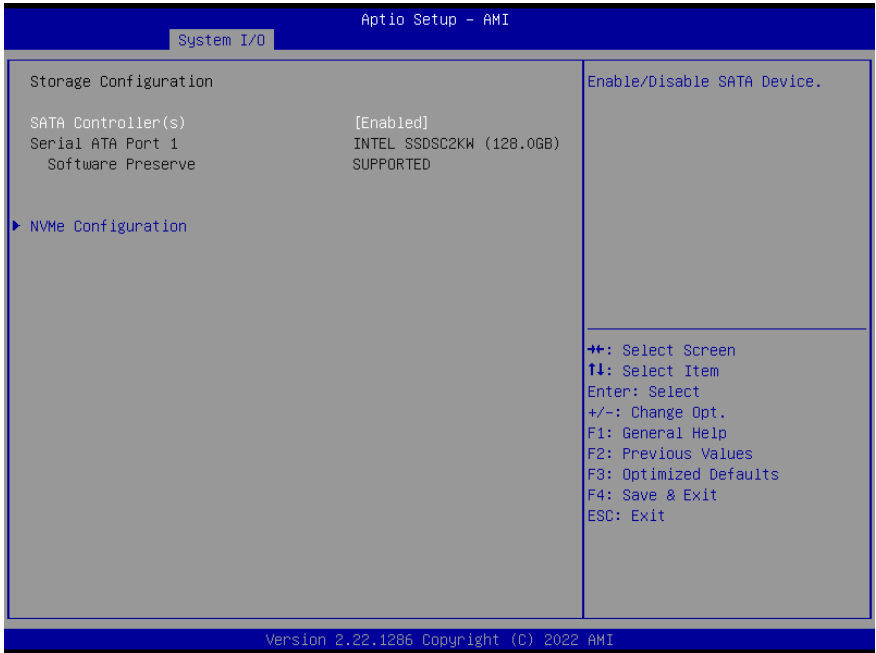

Options Summary		
SATA Controller(s)	Enabled	Optimal Default, Failsafe Default
	Disabled	
Enable/Disable SATA Device.		

3.5.2 HD Audio Configuration

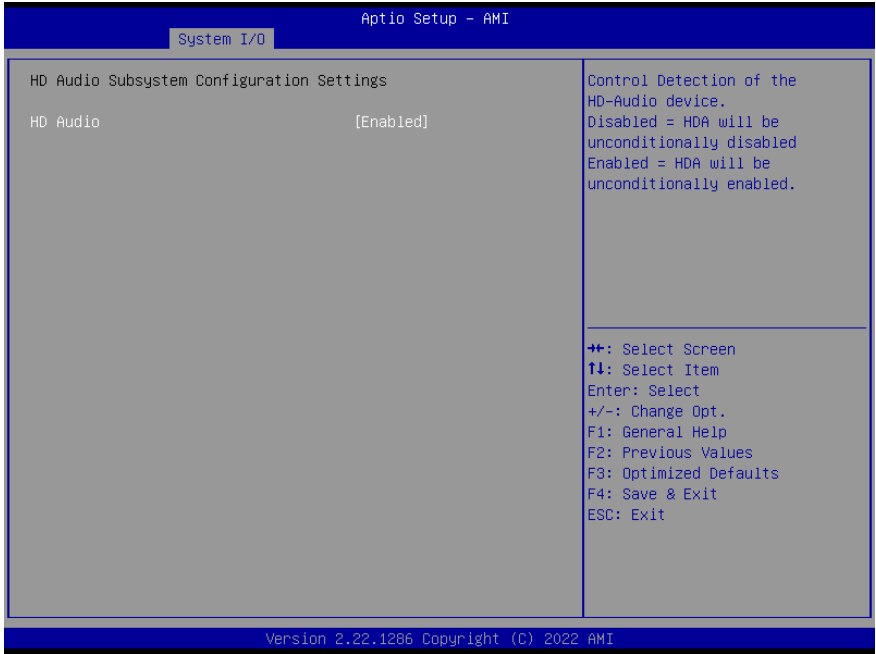

Options Summary		
HD Audio	Disabled	
	Enabled	Optimal Default, Failsafe Default
Control Detection of the HD-Audio device. Disabled = HDA will be unconditionally disabled. Enabled = HDA will be unconditionally enabled.		

3.5.3 Digital IO Port Configuration

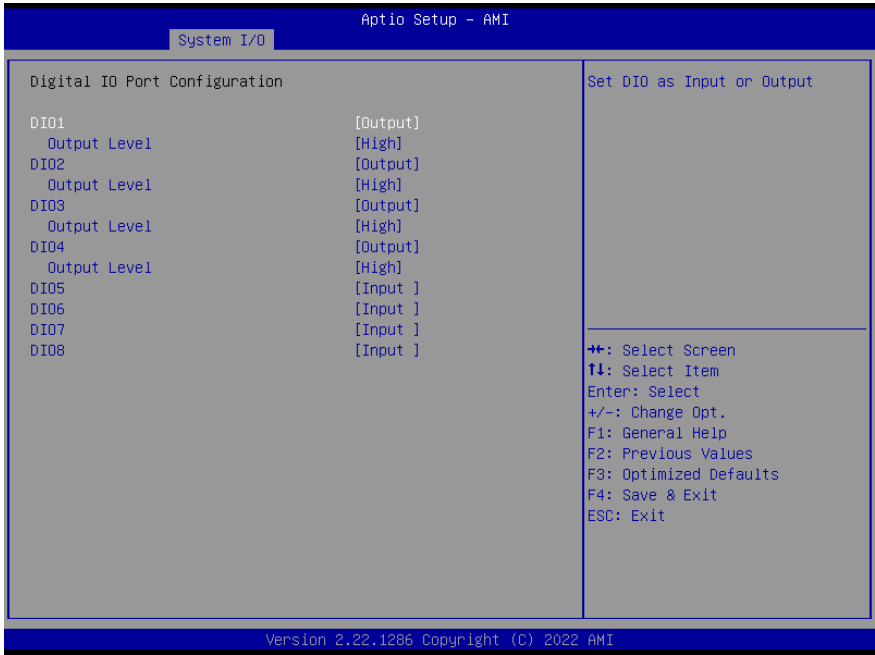

Options Summary		
DIO1	Input	
	Output	Optimal Default, Failsafe Default
Set DIO as Input or Output.		
Output Level	Low	
	High	Optimal Default, Failsafe Default
Set output level when DIO pin is Output.		
DIO2	Input	
	Output	Optimal Default, Failsafe Default
Set DIO as Input or Output.		
Output Level	Low	
	High	Optimal Default, Failsafe Default
Set output level when DIO pin is Output.		
DIO3	Input	
	Output	Optimal Default, Failsafe Default
Set DIO as Input or Output.		

Options Summary		
Output Level	Low	
	High	Optimal Default, Failsafe Default
Set output level when DIO pin is Output.		
DIO4	Input	
	Output	Optimal Default, Failsafe Default
Set DIO as Input or Output.		
Output Level	Low	
	High	Optimal Default, Failsafe Default
Set output level when DIO pin is Output.		
DIO5	Input	Optimal Default, Failsafe Default
	Output	
Set DIO as Input or Output.		
DIO6	Input	Optimal Default, Failsafe Default
	Output	
Set DIO as Input or Output.		
DIO7	Input	Optimal Default, Failsafe Default
	Output	
Set DIO as Input or Output.		
DIO8	Input	Optimal Default, Failsafe Default
	Output	
Set DIO as Input or Output.		

3.5.4 Legacy Logical Devices Configuration



3.5.4.1 Serial Port 1

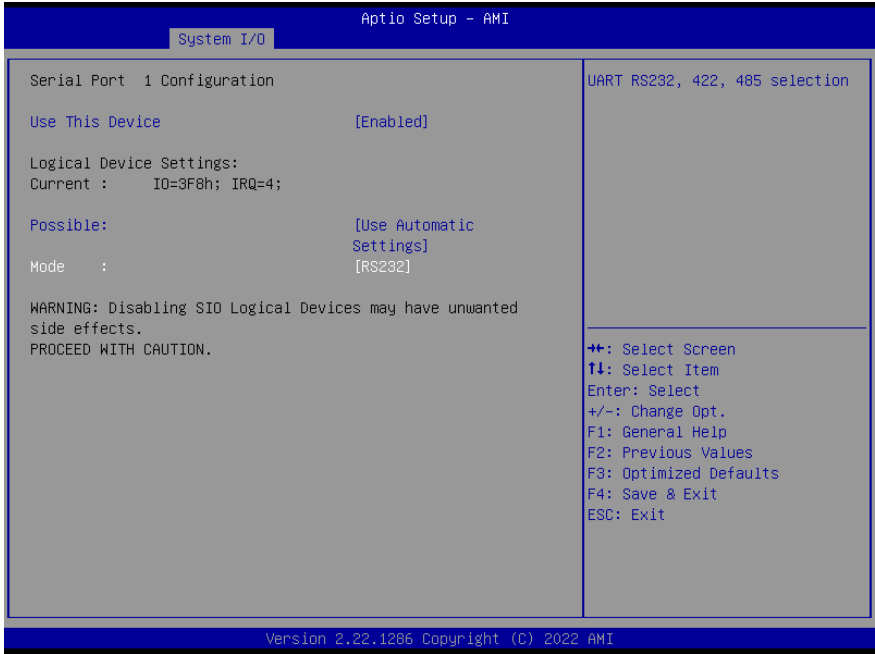

Options Summary		
Use This Device	Disabled	
	Enabled	Optimal Default, Failsafe Default
Enable or Disable this Logical Device.		
Possible:	Use Automatic Settings	Optimal Default, Failsafe Default
	IO=3F8; IRQ=4;	
	IO=2F8; IRQ=3;	
Allows the user to change the device resource settings. New settings will be reflected on this setup page after system restarts.		
Mode	RS232	Optimal Default, Failsafe Default
	RS422	
	RS485	
UART RS232, 422, 485, selection.		

3.5.4.2 Serial Port 2

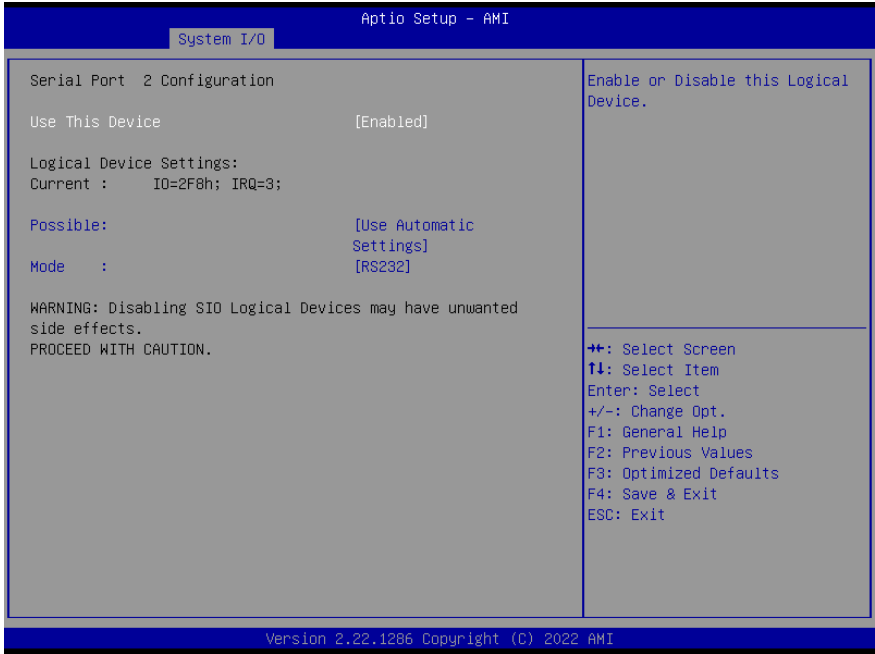

Options Summary		
Use This Device	Disabled	
	Enabled	Optimal Default, Failsafe Default
Enable or Disable this Logical Device.		
Possible:	Use Automatic Settings	Optimal Default, Failsafe Default
	IO=2F8; IRQ=3;	
	IO=3F8; IRQ=4;	
Allows the user to change the device resource settings. New settings will be reflected on this setup page after system restarts.		
Mode	RS232	Optimal Default, Failsafe Default
	RS422	
	RS485	
UART RS232, 422, 485, selection.		

3.5.5 Serial Port Console Redirection

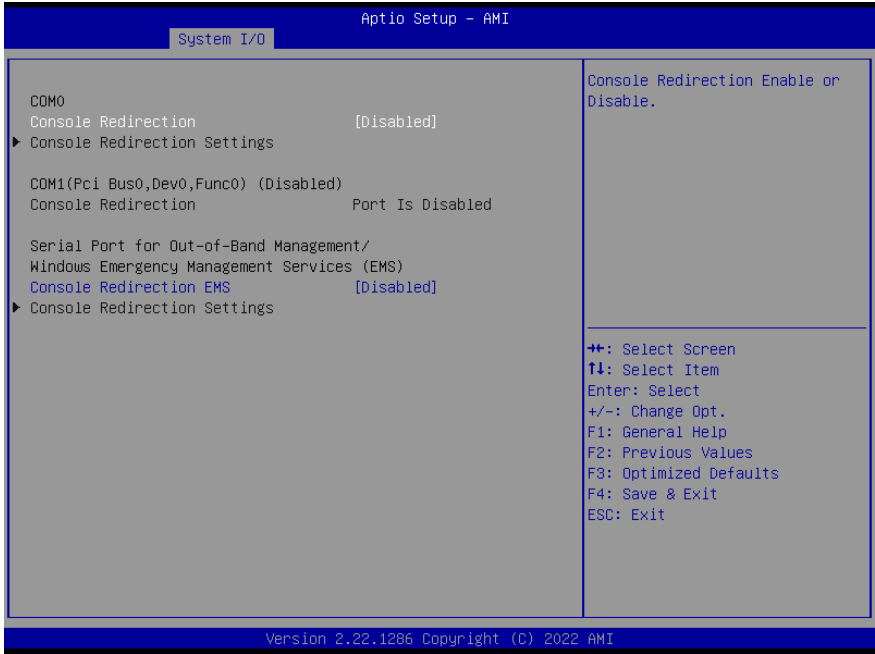

Options Summary		
Console Redirection	Disabled	Optimal Default, Failsafe Default
	Enabled	
Console Redirection Enable or Disable.		
Console Redirection EMS	Disabled	Optimal Default, Failsafe Default
	Enabled	
Console Redirection Enable or Disable.		

3.5.5.1 Console Redirection Settings (COM0)

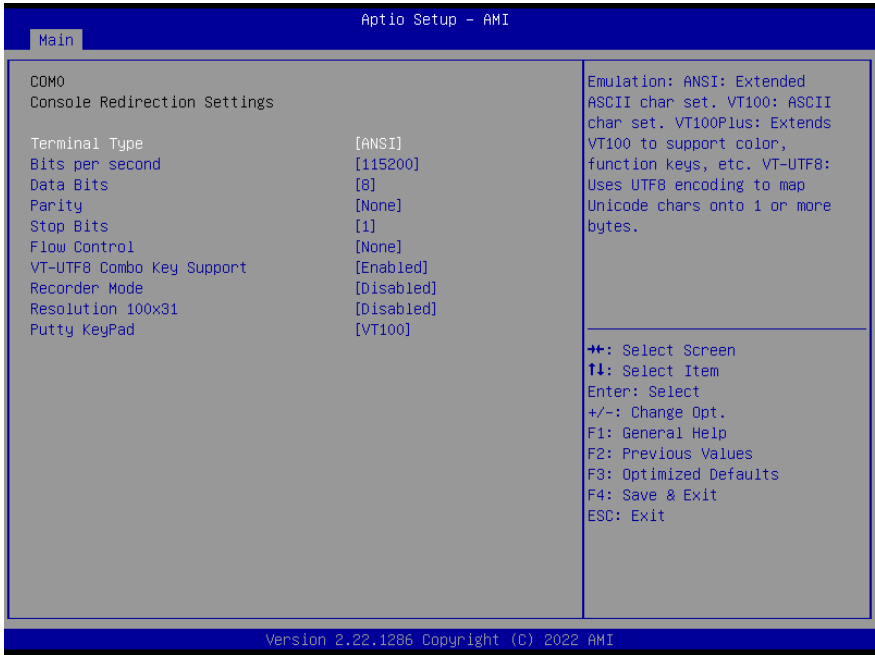

Options Summary		
Terminal Type	VT100	
	VT100Plus	
	VT-UTF8	
	ANSI	Optimal Default, Failsafe Default
Emulation: ANSI: Extended ASCII char set. VT100: ASCII char set. VT100Plus: Extends VT100 to support color, function keys, etc. VT-UTF8: Uses UTF8 encoding to map Unicode chars onto 1 or more bytes.		
Bits per second	9600	
	19200	
	38400	
	57600	
	115200	Optimal Default, Failsafe Default

Options Summary		
Selects serial port transmission speed. The speed must be matched on the other side. Long or noisy lines may require lower speeds.		
Data Bits	7	
	8	Optimal Default, Failsafe Default
Data Bits.		
Parity	None	Optimal Default, Failsafe Default
	Even	
	Odd	
	Mark	
	Space	
A parity bit can be sent with the data bits to detect some transmission errors. Even: parity bit is 0 if the num of 1's in the data bits is even. Odd: parity bit is 0 if num of 1's in the data bits is odd. Mark: parity bit is always 1. Space: Parity bit is always 0. Mark and Space Parity do not allow for error detection. They can be used as an additional data bit.		
Stop Bits	1	Optimal Default, Failsafe Default
	2	
Stop bits indicate the end of a serial data packet. (A start bit indicates the beginning). The standard setting is 1 stop bit. Communication with slow devices may require more than 1 stop bit.		
Flow Control	None	Optimal Default, Failsafe Default
	Hardware RTS/CTS	
Flow control can prevent data loss from buffer overflow. When sending data, if the receiving buffers are full, a 'stop' signal can be sent to stop the data flow. Once the buffers are empty, a 'start' signal can be sent to re-start the flow. Hardware flow control uses two wires to send start/stop signals.		
VT-UTF8 Combo Key Support	Disabled	
	Enabled	Optimal Default, Failsafe Default
Enable VT-UTF8 Combination Key Support for ANSI/VT100 terminals		
Recorder Mode	Disabled	Optimal Default, Failsafe Default
	Enabled	
With this mode enabled only text will be sent. This is to capture Terminal data.		
Resolution 100x31	Disabled	Optimal Default, Failsafe Default
	Enabled	
Enables or disables extended terminal resolution.		

Options Summary		
Putty KeyPad	VT100	Optimal Default, Failsafe Default
	LINUX	
	XTERMR6	
	SCO	
	ESCN	
	VT400	
Select FunctionKey and KeyPad on Putty.		

3.5.5.2 Console Redirection Settings (Out-of-Band Mgmt Port)

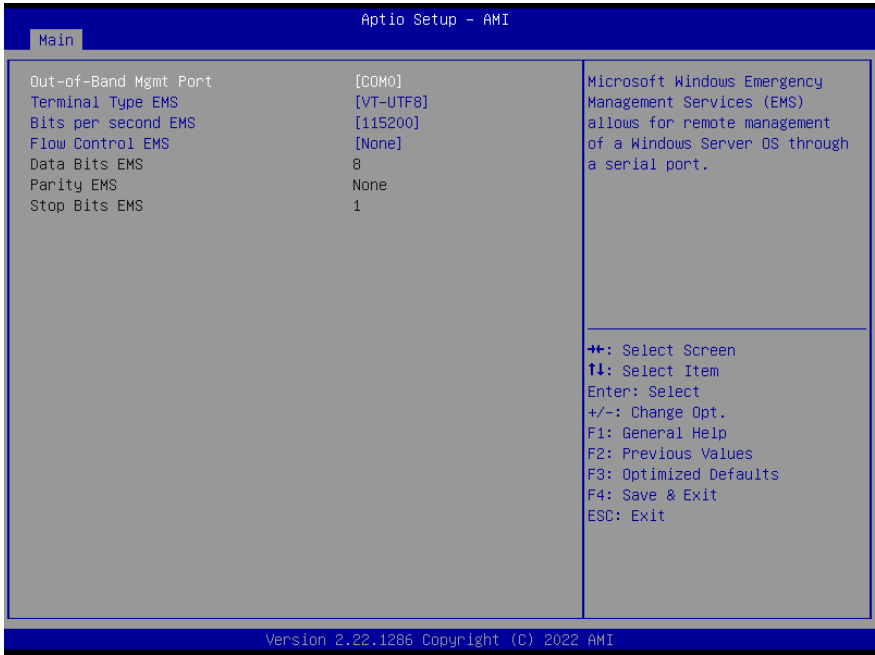

Options Summary		
Out-of-Band Mgmt Port	COM0	Optimal Default, Failsafe Default
	COM1(Pci Bus0, Dev0, Func0) (Disabled)	
Microsoft Windows Emergency Management Services (EMS) allows for remote management of a Windows Server OS through a serial port.		
Terminal Type EMS	VT100	
	VT100Plus	
	VT-UTF8	Optimal Default, Failsafe Default
	ANSI	
<p>VT-UTF8 is the preferred terminal type for out-of-band management. The next best choice is VT100+ and then VT100. See above, in Console Redirection Settings page, for more Help with Terminal Type/Emulation.</p>		

Options Summary		
Bits per second EMS	9600	
	19200	
	57600	
	115200	Optimal Default, Failsafe Default
Selects serial port transmission speed. The speed must be matched on the other side. Long or noisy lines may require lower speeds.		
Flow Control EMS	None	Optimal Default, Failsafe Default
	Hardware RTS/CTS	
	Software Xon/Xoff	
Flow control can prevent data loss from buffer overflow. When sending data, if the receiving buffers are full, a 'stop' signal can be sent to stop the data flow. Once the buffers are empty, a 'start' signal can be sent to re-start the flow. Hardware flow control uses two wires to send start/stop signals.		

3.6 Setup Submenu: Security

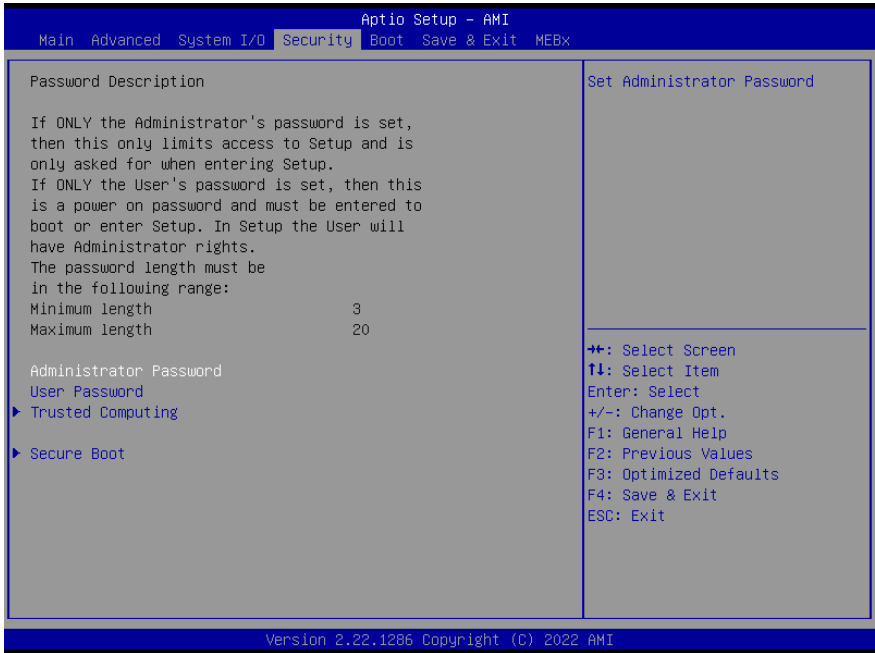

Change User/Administrator Password

You can set a User Password once an Administrator Password. The password will be required during boot up, or when the user enters the Setup utility. Please Note that a User Password does not provide access to many of the features in the Setup utility. Select the password you wish to set, press Enter to open a dialog box to enter your password (you can enter no more than six letters or numbers). Press Enter to confirm your entry, after which you will be prompted to retype your password for a final confirmation. Press Enter again after you have retyped it correctly.

Removing the Password

Highlight this item and type in the current password. At the next dialog box press Enter to disable password protection.

3.6.1 Trusted Computing

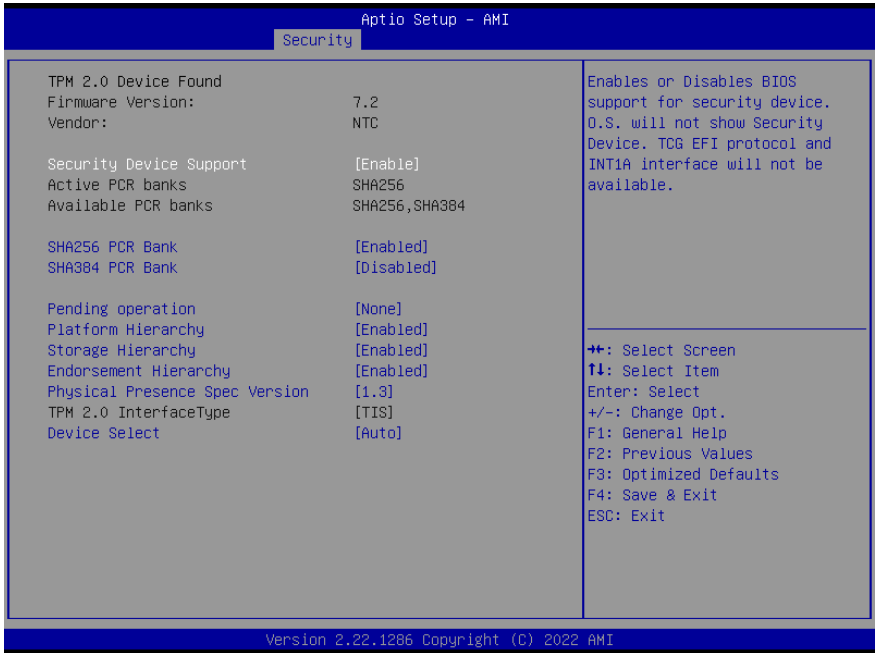

Options Summary		
Security Device Support	Enable	Optimal Default, Failsafe Default
	Disable	
Enables or Disables BIOS support for security device. O.S. will not show Security Device. TCG EFI protocol and INT1A interface will not be available.		
SHA256 PCR Bank	Disabled	
	Enabled	Optimal Default, Failsafe Default
Enable or Disable SHA256 PCR Bank.		
SHA384 PCR Bank	Disabled	Optimal Default, Failsafe Default
	Enabled	
Enable or Disable SHA384 PCR Bank.		
Pending operation	None	Optimal Default, Failsafe Default
	TPM Clear	
Schedule an Operation for the Security Device.		
Note: Your Computer will reboot during restart in order to change State of Security Device.		

Options Summary		
Platform Hierarchy	Disabled	
	Enabled	Optimal Default, Failsafe Default
Enable or Disable Platform Hierarchy.		
Storage Hierarchy	Disabled	
	Enabled	Optimal Default, Failsafe Default
Enable or Disable Storage Hierarchy.		
Endorsement Hierarchy	Disabled	
	Enabled	Optimal Default, Failsafe Default
Enable or Disable Endorsement Hierarchy.		
Physical Presence Spec Version	1.2	
	1.3	Optimal Default, Failsafe Default
Select to Tell O.S. to support PPI Spec Version 1.2 or 1.3. Note some HCK tests might not support 1.3.		
Device Select	TPM 1.2	
	TPM 2.0	
	Auto	Optimal Default, Failsafe Default
TPM 1.2 will restrict support to TPM 1.2 devices, TPM 2.0 will restrict support to TPM 2.0 devices, Auto will support both with the default set to TPM 2.0 devices if not found, TPM 1.2 devices will be enumerated.		

3.6.2 Secure Boot

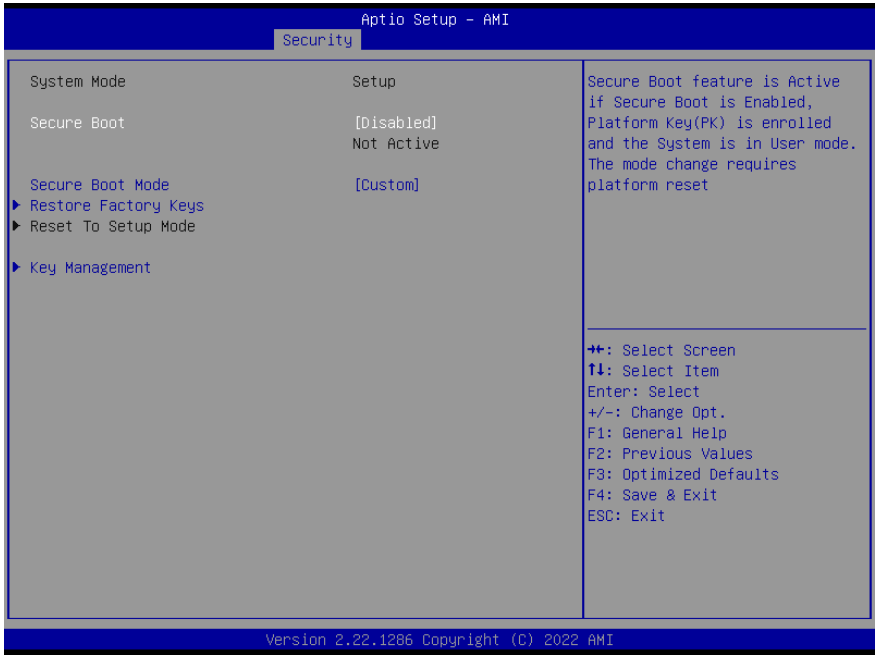

Options Summary		
Secure Boot	Disabled	Optimal Default, Failsafe Default
	Enabled	
Secure Boot feature is Active if Secure Boot is Enabled, Platform Key (PK) is enrolled and the System is in User mode. The mode change requires platform reset.		
Secure Boot Mode	Standard	
	Custom	Optimal Default, Failsafe Default
Secure Boot mode options: Standard or Custom. In Custom mode, Secure Boot Policy variables can be configured by a physically present user without full authentication.		
Restore Factory Keys	Yes	
	No	
Force System to User Mode. Install factory default Secure Boot key databases.		

3.6.2.1 Key Management

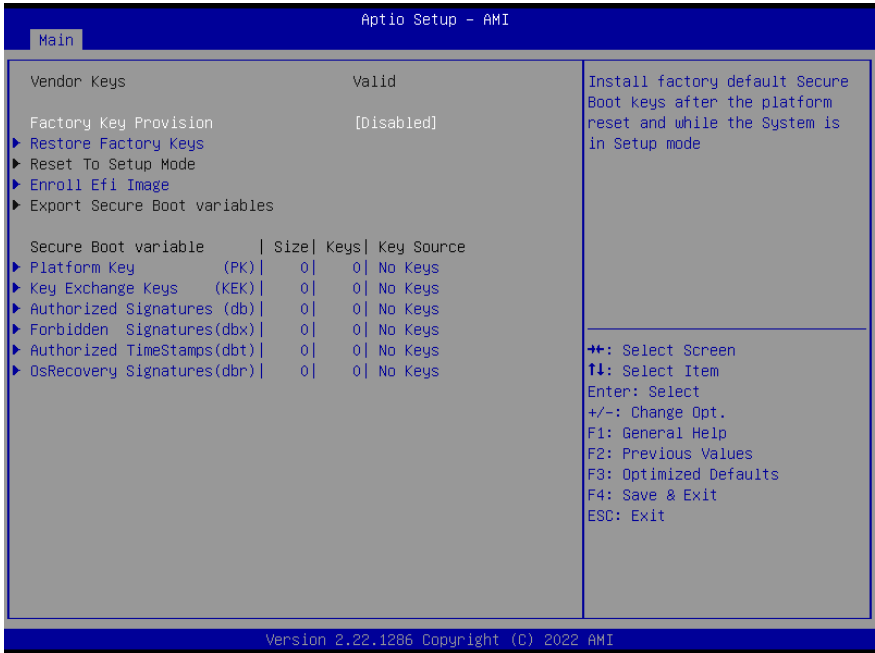

Options Summary		
Factory Key Provision	Disabled	Optimal Default, Failsafe Default
	Enabled	
Install factory default Secure Boot keys after the platform reset and while the System is in Setup mode.		
Restore Factory Keys	Yes	
	No	
Force System to User Mode. Install factory default Secure Boot key databases.		
Enroll Efi Image		
Allow Efi image to run in Secure Boot mode. Enroll SHA256 Hash certificate of a PE image into Authorized Signature Database (db).		
Platform Key (PK)	Update	
Key Exchange Keys (KEK)	Update	
	Append	
Authorized Signatures (db)	Update	
	Append	

Options Summary	
Forbidden Signatures (dbx)	Update
	Append
Authorized TimeStamps (dbt)	Update
	Append
OsRecovery Signatures (dbr)	Update
	Append
Enroll Factory Defaults or load certificates from a file:	
1. Public Key Certificate:	
a) EFI_SIGNATURE_LIST	
b) EFI_CERT_X509 (DER)	
c) EFI_CERT_RSA2048 (bin)	
d) EFI_CERT_SHAXXX	
2. Authenticated UEFI Variable	
3. EFI PE/COFF Image (SHA256)	
Key Source: Factory, External, Mixed	

3.7 Setup Submenu: Boot

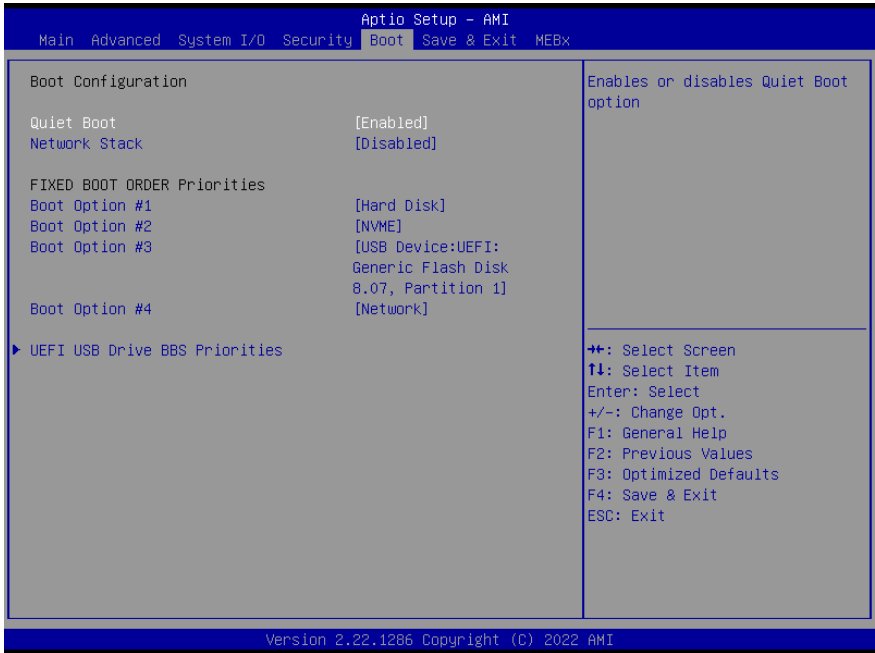

Options Summary		
Quiet Boot	Disabled	
	Enabled	Default
Enables/disables Quiet Boot option.		
Network Stack	Disabled	Default
	Enabled	
Enable/Disable UEFI Network Stack.		
Boot Option #1	Hard Disk	
Boot Option #2	NVME	
Boot Option #3	USB Device	
Boot Option #4	Network	
Sets the system boot order.		

3.7.1 UEFI BBS Priorities



Options Summary		
Quiet Boot	Disabled	
	Enabled	Default
Enables/disables Quiet Boot option.		
Network Stack	Disabled	Default
	Enabled	
Enable/Disable UEFI Network Stack.		
Boot Option #1	Hard Disk	
Boot Option #2	NVME	
Boot Option #3	USB Device	
Boot Option #4	Network	
Sets the system boot order.		

3.8 Setup Submenu: Save & Exit



3.9 Setup Submenu: MEBx



Chapter 4

Drivers Installation

4.1 Drivers Download and Installation

Drivers for the BOXER-6751-ADP can be downloaded from the product page on the AAEON website by following this link:

<https://www.aaeon.com/en/p/compact-fanless-box-pc-solutions-boxer-6751-adp>

Download the driver(s) you need and follow the steps below to install them.

Install Chipset Driver

1. Open the **Chipset** folder
2. Run the **SetupChipset.exe** file in the folder
3. Follow the instructions
4. Drivers will be installed automatically

Install Graphics Driver

1. Open the **Graphics** folder
2. Run the **Installer.exe** file in the folder
3. Follow the instructions
4. Drivers will be installed automatically

Install LAN Driver

1. Open the **LAN** folder
2. Run the **Autorun.exe** file in the folder
3. Follow the instructions
4. Drivers will be installed automatically

Install Audio Drivers

Note: Ensure Intel Smart Sound Driver (**ADSP-10.29.00.8467**) is installed before the Realtek Audio driver (**Realtek Audio 6.0.9239.1**)

Install Intel Smart Sound Driver

1. Open the **Audio (ADSP-10.29.00.8467)** folder
2. Follow the setup information within the file to manually install driver.

Install Realtek Audio Driver

1. Open the Intel Smart Sound Driver (**ADSP-10.29.00.8467**) folder
2. Run the **Setup.exe** file in the folder
3. Follow the instructions
4. Driver will be installed automatically

Install ME Driver

1. Open the **ME** folder
2. Run the **SetupME.exe** file in the folder
3. Follow the instructions
4. Drivers will be installed automatically

Install Serial Port Patch (Optional)

1. Open the **Serial Port Driver (Optional)** folder
2. Run the **FintekSerial.exe** file in the folder
3. Follow the instructions
4. Drivers will be installed automatically

Appendix A

I/O Information

A.1 I/O Address Map

The screenshot displays the Windows Device Manager window for a system named 'DESKTOP-1N48F93'. The 'Input/output (I/O)' category is expanded, showing a list of hardware devices with their corresponding I/O address ranges. The devices listed include:

- PCI Express Root Complex
- Programmable interrupt controller (multiple instances)
- Motherboard resources (multiple instances)
- System timer
- Fintek Communications Port (COM2)
- Fintek Communications Port (COM1)
- Standard SATA AHCI Controller (multiple instances)
- Intel(R) UHD Graphics
- Intel(R) Active Management Technology - SOL (COM3)

A.2 Memory Address Map

The screenshot displays the Windows Device Manager interface for a system named 'DESKTOP-1N48F93'. The 'Memory' category is expanded, showing a list of hardware devices with their corresponding memory addresses and descriptions. The devices listed include various controllers, motherboards, and graphics cards.

Device Name	Memory Address Range
Input/output (IO)	
Interrupt request (IRQ)	
Large Memory	
PCI Express Root Complex	[0000000400000000 - 0000007FFFFFFF]
Memory	
PCI Express Root Complex	[0000000000A0000 - 0000000000BFFFF]
Intel(R) Ethernet Controller I226-LM	[0000000080400000 - 00000000804FFFF]
Intel(R) PCI Express Root Port #10 - 51B1	[0000000080400000 - 00000000805FFFF]
PCI Express Root Complex	[0000000080400000 - 00000000BFFFFFF]
Intel(R) Ethernet Controller I226-LM	[0000000080500000 - 0000000080503FFF]
Standard SATA AHCI Controller	[0000000080620000 - 0000000080621FFF]
Standard SATA AHCI Controller	[0000000080622000 - 00000000806227FF]
Standard SATA AHCI Controller	[0000000080623000 - 00000000806230FF]
Intel(R) Active Management Technology - SOL (COM3)	[00000000BFFDF000 - 00000000BFFDFFFF]
Intel(R) Ethernet Connection (16) I219-LM	[00000000BFFE0000 - 00000000BFFFFFF]
Motherboard resources	[00000000C0000000 - 00000000CFFFFFF]
Intel(R) SPI (flash) Controller - 51A4	[00000000FE010000 - 00000000FE010FFF]
High precision event timer	[00000000FED00000 - 00000000FED003FF]
Motherboard resources	[00000000FED20000 - 00000000FED7FFF]
Trusted Platform Module 2.0	[00000000FED40000 - 00000000FED44FFF]
Motherboard resources	[00000000FED45000 - 00000000FED8FFF]
Motherboard resources	[00000000FED90000 - 00000000FED93FFF]
Motherboard resources	[00000000FEDA0000 - 00000000FEDA0FFF]
Motherboard resources	[00000000FEDA1000 - 00000000FEDA1FFF]
Motherboard resources	[00000000FEDC0000 - 00000000FEDC7FFF]
Motherboard resources	[00000000FEE00000 - 00000000FEEFFFF]
Intel(R) UHD Graphics	[0000004000000000 - 000000400FFFF]
Intel(R) UHD Graphics	[0000006000000000 - 0000006000FFFF]
Intel(R) USB 3.10 eXtensible Host Controller - 1.20 (Microsoft)	[0000006001100000 - 000000600110FFFF]
Intel(R) Management Engine Interface #1	[00000077FFEFB000 - 00000077FFEFBFFF]
High Definition Audio Controller	[00000077FFEFCC000 - 00000077FFEFCEFFF]
High Definition Audio Controller	[00000077FFFF00000 - 00000077FFFF0FFFF]

A.3 IRQ Mapping Chart

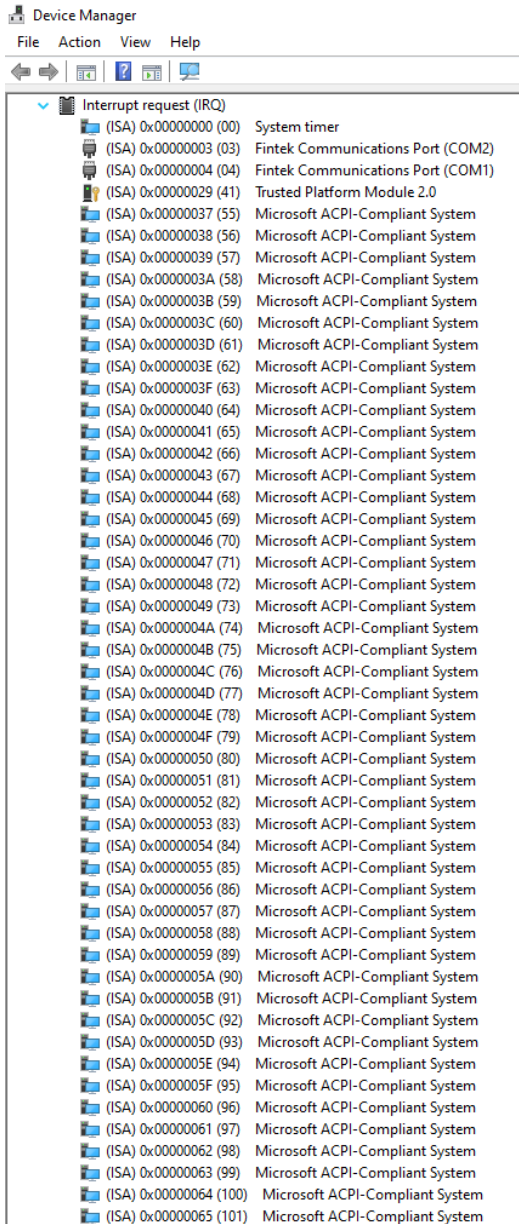

The screenshot shows the Windows Device Manager window with the 'Interrupt request (IRQ)' category expanded. The list contains 32 entries, each with an icon, an ISA address in parentheses, and a device name. The devices include a system timer, two Fintek Communications Ports (COM2 and COM1), a Trusted Platform Module 2.0, and 29 Microsoft ACPI-Compliant System devices.

ISA Address	Device Name
(ISA) 0x00000000 (00)	System timer
(ISA) 0x00000003 (03)	Fintek Communications Port (COM2)
(ISA) 0x00000004 (04)	Fintek Communications Port (COM1)
(ISA) 0x00000029 (41)	Trusted Platform Module 2.0
(ISA) 0x00000037 (55)	Microsoft ACPI-Compliant System
(ISA) 0x00000038 (56)	Microsoft ACPI-Compliant System
(ISA) 0x00000039 (57)	Microsoft ACPI-Compliant System
(ISA) 0x0000003A (58)	Microsoft ACPI-Compliant System
(ISA) 0x0000003B (59)	Microsoft ACPI-Compliant System
(ISA) 0x0000003C (60)	Microsoft ACPI-Compliant System
(ISA) 0x0000003D (61)	Microsoft ACPI-Compliant System
(ISA) 0x0000003E (62)	Microsoft ACPI-Compliant System
(ISA) 0x0000003F (63)	Microsoft ACPI-Compliant System
(ISA) 0x00000040 (64)	Microsoft ACPI-Compliant System
(ISA) 0x00000041 (65)	Microsoft ACPI-Compliant System
(ISA) 0x00000042 (66)	Microsoft ACPI-Compliant System
(ISA) 0x00000043 (67)	Microsoft ACPI-Compliant System
(ISA) 0x00000044 (68)	Microsoft ACPI-Compliant System
(ISA) 0x00000045 (69)	Microsoft ACPI-Compliant System
(ISA) 0x00000046 (70)	Microsoft ACPI-Compliant System
(ISA) 0x00000047 (71)	Microsoft ACPI-Compliant System
(ISA) 0x00000048 (72)	Microsoft ACPI-Compliant System
(ISA) 0x00000049 (73)	Microsoft ACPI-Compliant System
(ISA) 0x0000004A (74)	Microsoft ACPI-Compliant System
(ISA) 0x0000004B (75)	Microsoft ACPI-Compliant System
(ISA) 0x0000004C (76)	Microsoft ACPI-Compliant System
(ISA) 0x0000004D (77)	Microsoft ACPI-Compliant System
(ISA) 0x0000004E (78)	Microsoft ACPI-Compliant System
(ISA) 0x0000004F (79)	Microsoft ACPI-Compliant System
(ISA) 0x00000050 (80)	Microsoft ACPI-Compliant System
(ISA) 0x00000051 (81)	Microsoft ACPI-Compliant System
(ISA) 0x00000052 (82)	Microsoft ACPI-Compliant System
(ISA) 0x00000053 (83)	Microsoft ACPI-Compliant System
(ISA) 0x00000054 (84)	Microsoft ACPI-Compliant System
(ISA) 0x00000055 (85)	Microsoft ACPI-Compliant System
(ISA) 0x00000056 (86)	Microsoft ACPI-Compliant System
(ISA) 0x00000057 (87)	Microsoft ACPI-Compliant System
(ISA) 0x00000058 (88)	Microsoft ACPI-Compliant System
(ISA) 0x00000059 (89)	Microsoft ACPI-Compliant System
(ISA) 0x0000005A (90)	Microsoft ACPI-Compliant System
(ISA) 0x0000005B (91)	Microsoft ACPI-Compliant System
(ISA) 0x0000005C (92)	Microsoft ACPI-Compliant System
(ISA) 0x0000005D (93)	Microsoft ACPI-Compliant System
(ISA) 0x0000005E (94)	Microsoft ACPI-Compliant System
(ISA) 0x0000005F (95)	Microsoft ACPI-Compliant System
(ISA) 0x00000060 (96)	Microsoft ACPI-Compliant System
(ISA) 0x00000061 (97)	Microsoft ACPI-Compliant System
(ISA) 0x00000062 (98)	Microsoft ACPI-Compliant System
(ISA) 0x00000063 (99)	Microsoft ACPI-Compliant System
(ISA) 0x00000064 (100)	Microsoft ACPI-Compliant System
(ISA) 0x00000065 (101)	Microsoft ACPI-Compliant System

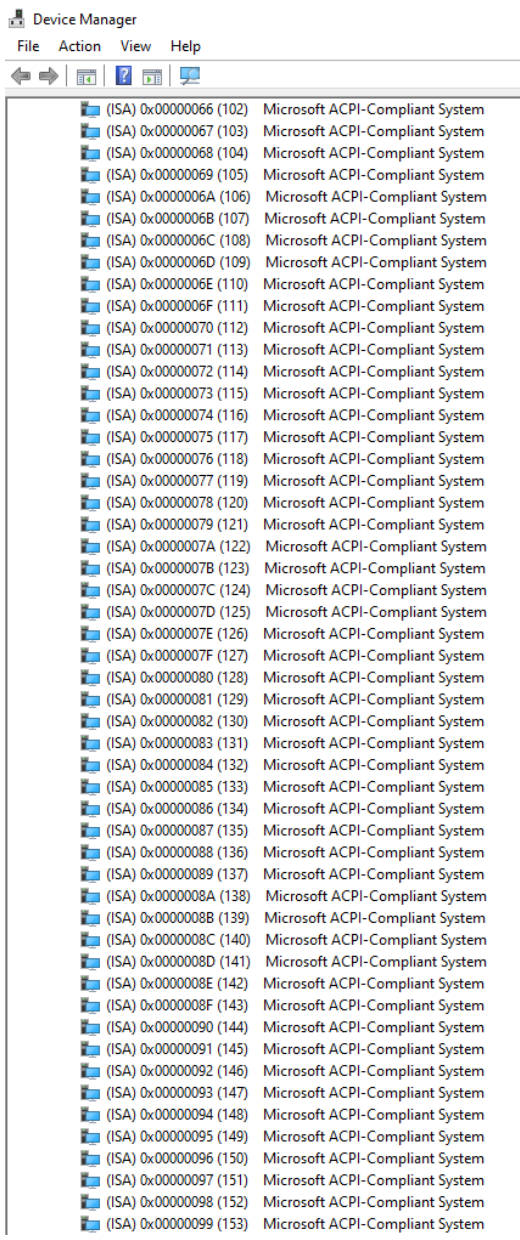

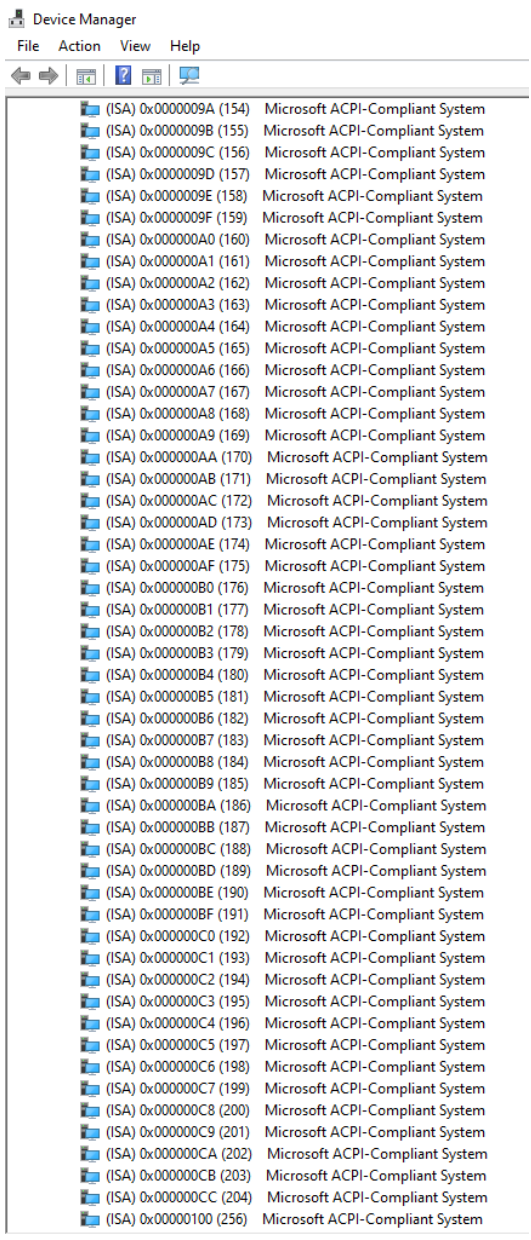

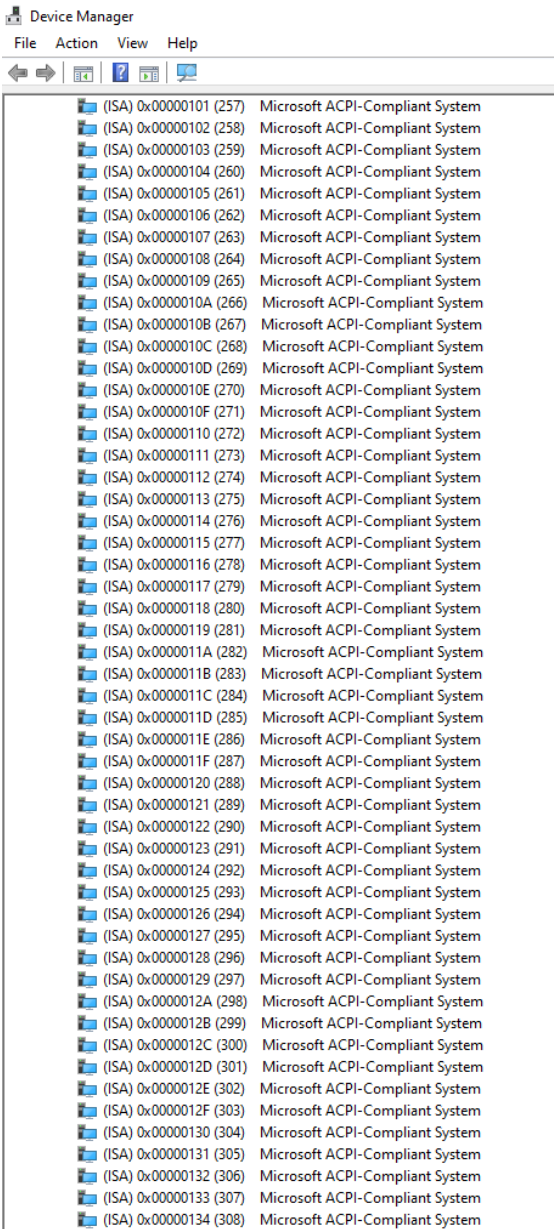

Device Manager





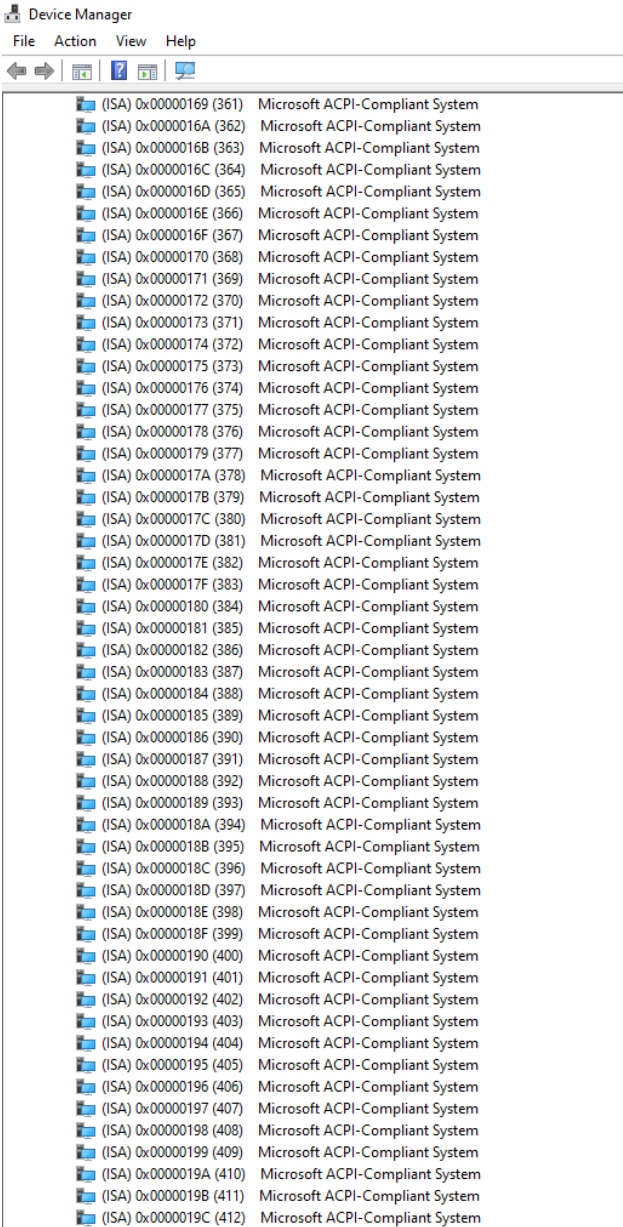

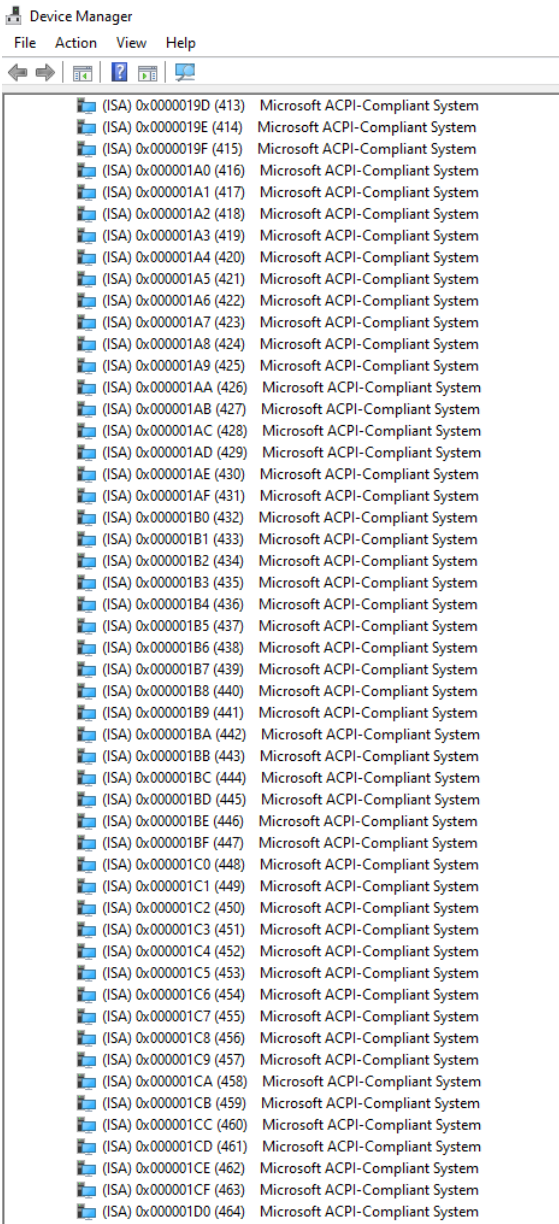

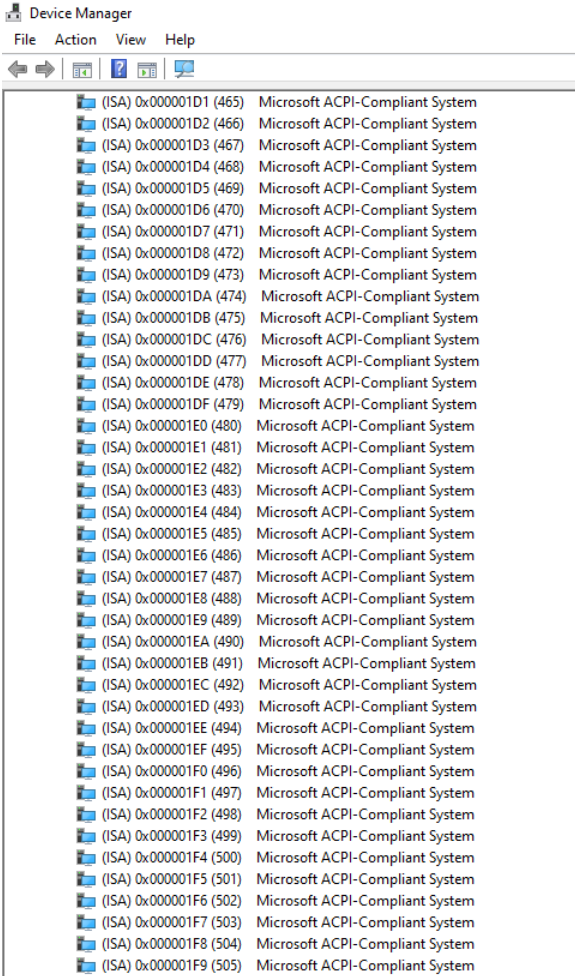















File Action View Help

	(ISA) 0x0000135 (309)	Microsoft ACPI-Compliant System
	(ISA) 0x0000136 (310)	Microsoft ACPI-Compliant System
	(ISA) 0x0000137 (311)	Microsoft ACPI-Compliant System
	(ISA) 0x0000138 (312)	Microsoft ACPI-Compliant System
	(ISA) 0x0000139 (313)	Microsoft ACPI-Compliant System
	(ISA) 0x000013A (314)	Microsoft ACPI-Compliant System
	(ISA) 0x000013B (315)	Microsoft ACPI-Compliant System
	(ISA) 0x000013C (316)	Microsoft ACPI-Compliant System
	(ISA) 0x000013D (317)	Microsoft ACPI-Compliant System
	(ISA) 0x000013E (318)	Microsoft ACPI-Compliant System
	(ISA) 0x000013F (319)	Microsoft ACPI-Compliant System
	(ISA) 0x0000140 (320)	Microsoft ACPI-Compliant System
	(ISA) 0x0000141 (321)	Microsoft ACPI-Compliant System
	(ISA) 0x0000142 (322)	Microsoft ACPI-Compliant System
	(ISA) 0x0000143 (323)	Microsoft ACPI-Compliant System
	(ISA) 0x0000144 (324)	Microsoft ACPI-Compliant System
	(ISA) 0x0000145 (325)	Microsoft ACPI-Compliant System
	(ISA) 0x0000146 (326)	Microsoft ACPI-Compliant System
	(ISA) 0x0000147 (327)	Microsoft ACPI-Compliant System
	(ISA) 0x0000148 (328)	Microsoft ACPI-Compliant System
	(ISA) 0x0000149 (329)	Microsoft ACPI-Compliant System
	(ISA) 0x000014A (330)	Microsoft ACPI-Compliant System
	(ISA) 0x000014B (331)	Microsoft ACPI-Compliant System
	(ISA) 0x000014C (332)	Microsoft ACPI-Compliant System
	(ISA) 0x000014D (333)	Microsoft ACPI-Compliant System
	(ISA) 0x000014E (334)	Microsoft ACPI-Compliant System
	(ISA) 0x000014F (335)	Microsoft ACPI-Compliant System
	(ISA) 0x0000150 (336)	Microsoft ACPI-Compliant System
	(ISA) 0x0000151 (337)	Microsoft ACPI-Compliant System
	(ISA) 0x0000152 (338)	Microsoft ACPI-Compliant System
	(ISA) 0x0000153 (339)	Microsoft ACPI-Compliant System
	(ISA) 0x0000154 (340)	Microsoft ACPI-Compliant System
	(ISA) 0x0000155 (341)	Microsoft ACPI-Compliant System
	(ISA) 0x0000156 (342)	Microsoft ACPI-Compliant System
	(ISA) 0x0000157 (343)	Microsoft ACPI-Compliant System
	(ISA) 0x0000158 (344)	Microsoft ACPI-Compliant System
	(ISA) 0x0000159 (345)	Microsoft ACPI-Compliant System
	(ISA) 0x000015A (346)	Microsoft ACPI-Compliant System
	(ISA) 0x000015B (347)	Microsoft ACPI-Compliant System
	(ISA) 0x000015C (348)	Microsoft ACPI-Compliant System
	(ISA) 0x000015D (349)	Microsoft ACPI-Compliant System
	(ISA) 0x000015E (350)	Microsoft ACPI-Compliant System
	(ISA) 0x000015F (351)	Microsoft ACPI-Compliant System
	(ISA) 0x0000160 (352)	Microsoft ACPI-Compliant System
	(ISA) 0x0000161 (353)	Microsoft ACPI-Compliant System
	(ISA) 0x0000162 (354)	Microsoft ACPI-Compliant System
	(ISA) 0x0000163 (355)	Microsoft ACPI-Compliant System
	(ISA) 0x0000164 (356)	Microsoft ACPI-Compliant System
	(ISA) 0x0000165 (357)	Microsoft ACPI-Compliant System
	(ISA) 0x0000166 (358)	Microsoft ACPI-Compliant System
	(ISA) 0x0000167 (359)	Microsoft ACPI-Compliant System
	(ISA) 0x0000168 (360)	Microsoft ACPI-Compliant System







	(ISA) 0x000001FA (506)	Microsoft ACPI-Compliant System
	(ISA) 0x000001FB (507)	Microsoft ACPI-Compliant System
	(ISA) 0x000001FC (508)	Microsoft ACPI-Compliant System
	(ISA) 0x000001FD (509)	Microsoft ACPI-Compliant System
	(ISA) 0x000001FE (510)	Microsoft ACPI-Compliant System
	(ISA) 0x000001FF (511)	Microsoft ACPI-Compliant System
	(PCI) 0x00000010 (16)	High Definition Audio Controller
	(PCI) 0x00000013 (19)	Intel(R) Active Management Technology - SOL (COM3)
	(PCI) 0xFFFFFFF0 (-17)	Intel(R) Management Engine Interface #1
	(PCI) 0xFFFFFFF0 (-16)	Intel(R) Ethernet Connection (16) I219-LM
	(PCI) 0xFFFFFFF1 (-15)	Intel(R) Ethernet Controller I226-LM
	(PCI) 0xFFFFFFF2 (-14)	Intel(R) Ethernet Controller I226-LM
	(PCI) 0xFFFFFFF3 (-13)	Intel(R) Ethernet Controller I226-LM
	(PCI) 0xFFFFFFF4 (-12)	Intel(R) Ethernet Controller I226-LM
	(PCI) 0xFFFFFFF5 (-11)	Intel(R) Ethernet Controller I226-LM
	(PCI) 0xFFFFFFF6 (-10)	Intel(R) Ethernet Controller I226-LM
	(PCI) 0xFFFFFFF7 (-9)	Intel(R) Ethernet Controller I226-LM
	(PCI) 0xFFFFFFF8 (-8)	Intel(R) Ethernet Controller I226-LM
	(PCI) 0xFFFFFFF9 (-7)	Intel(R) Ethernet Controller I226-LM
	(PCI) 0xFFFFFFFA (-6)	Intel(R) Ethernet Controller I226-LM
	(PCI) 0xFFFFFFF5 (-5)	Intel(R) Ethernet Controller I226-LM
	(PCI) 0xFFFFFFF4 (-4)	Intel(R) UHD Graphics
	(PCI) 0xFFFFFFF3 (-3)	Intel(R) USB 3.10 eXtensible Host Controller - 1.20 (Microsoft)
	(PCI) 0xFFFFFFF2 (-2)	Standard SATA AHCI Controller