

BOXER-6643-TGU

Fanless Embedded Box PC

User's Manual 1st Ed

Copyright Notice

This document is copyrighted, 2021. All rights are reserved. The original manufacturer reserves the right to make improvements to the products described in this manual at any time without notice.

No part of this manual may be reproduced, copied, translated, or transmitted in any form or by any means without the prior written permission of the original manufacturer. Information provided in this manual is intended to be accurate and reliable. However, the original manufacturer assumes no responsibility for its use, or for any infringements upon the rights of third parties that may result from its use.

The material in this document is for product information only and is subject to change without notice. While reasonable efforts have been made in the preparation of this document to assure its accuracy, AAEON assumes no liabilities resulting from errors or omissions in this document, or from the use of the information contained herein.

AAEON reserves the right to make changes in the product design without notice to its users.

Acknowledgements

All other product name or trademarks are properties of their respective owners.

- Microsoft Windows® is a registered trademark of Microsoft Corp.
- Intel® and Celeron® are registered trademarks of Intel Corporation
- Intel Core™ is a trademark of Intel Corporation
- Ubuntu is a registered trademark of Canonical
- LINUX FOUNDATION is a registered trademark of the Linux Foundation. Linux® is the registered trademark of Linus Torvalds in the U.S. and other countries.

All other product names or trademarks are properties of their respective owners. The publisher of this document does not assume nor imply ownership of any trademarked product not listed herein.

Packing List

Before setting up your product, please make sure the following items have been shipped:

Item	Quantity
● BOXER-6643-TGU	1
● Wall-mount bracket	2
● Screw Package	1
● 3 Pin DC-In Power Connector	1

If any of these items are missing or damaged, please contact your distributor or sales representative immediately.

About this Document

This User's Manual contains all the essential information, such as detailed descriptions and explanations on the product's hardware and software features (if any), its specifications, dimensions, jumper/connector settings/definitions, and driver installation instructions (if any), to facilitate users in setting up their product.

Users may refer to the product page at AAEON.com for the latest version of this document.

Safety Precautions

Please read the following safety instructions carefully. It is advised that you keep this manual for future references

1. All cautions and warnings on the device should be noted.
2. Make sure the power source matches the power rating of the device.
3. Position the power cord so that people cannot step on it. Do not place anything over the power cord.
4. Always completely disconnect the power before working on the system's hardware.
5. No connections should be made when the system is powered as a sudden rush of power may damage sensitive electronic components.
6. If the device is not to be used for a long time, disconnect it from the power supply to avoid damage by transient over-voltage.
7. Always disconnect this device from any power supply before cleaning.
8. While cleaning, use a damp cloth instead of liquid or spray detergents.
9. Make sure the device is installed near a power outlet and is easily accessible.
10. Keep this device away from humidity.
11. Place the device on a solid surface during installation to prevent falls.
12. Do not cover the openings on the device to ensure optimal heat dissipation.
13. Watch out for high temperatures when the system is running.
14. Do not touch the heat sink or heat spreader when the system is running
15. Never pour any liquid into the openings. This could cause fire or electric shock.
16. As most electronic components are sensitive to static electrical charge, be sure to ground yourself to prevent static charge when installing the internal components. Use a grounding wrist strap and contain all electronic components in any static-shielded containers.

17. If any of the following situations arises, please contact our service personnel:
 - i. Damaged power cord or plug
 - ii. Liquid intrusion to the device
 - iii. Exposure to moisture
 - iv. Device is not working as expected or in a manner as described in this manual
 - v. The device is dropped or damaged
 - vi. Any obvious signs of damage displayed on the device
18. Do not leave this device in an uncontrolled environment with temperatures beyond the device's permitted storage temperatures (see chapter 1) to prevent damage.
19. Do NOT disassemble the motherboard so as not to damage the system or void your warranty.
20. If the thermal pad had been damaged, please contact AAEON's salesperson to purchase a new one. Do NOT use those of other brands.
21. The Hex Cylinder Coppers on the front panel are not removable.
22. Repeatedly assemble and disassemble the system may cause damages to the exterior paint and surface and screw holes.
23. Use the right size screwdriver.
24. Use the screwdriver correctly to remove screws from the system.

FCC Statement

Warning!



This device complies with Part 15 FCC Rules. Operation is subject to the following two conditions: (1) this device may not cause harmful interference, and (2) this device must accept any interference received including interference that may cause undesired operation.

Caution:

There is a danger of explosion if the battery is incorrectly replaced. Replace only with the same or equivalent type recommended by the manufacturer. Dispose of used batteries according to the manufacturer's instructions and your local government's recycling or disposal directives.

Attention:

Il y a un risque d'explosion si la batterie est remplacée de façon incorrecte. Ne la remplacer qu'avec le même modèle ou équivalent recommandé par le constructeur. Recycler les batteries usées en accord avec les instructions du fabricant et les directives gouvernementales de recyclage.

产品中有毒有害物质或元素名称及含量

AAEON System

QO4-381 Rev.A0

部件名称	有毒有害物质或元素					
	铅 (Pb)	汞 (Hg)	镉 (Cd)	六价铬 (Cr(VI))	多溴联苯 (PBB)	多溴二苯 醚(PBDE)
印刷电路板 及其电子组件	×	○	○	○	○	○
外部信号 连接器及线材	×	○	○	○	○	○
外壳	○	○	○	○	○	○
中央处理器 与内存	×	○	○	○	○	○
硬盘	×	○	○	○	○	○
液晶模块	×	×	○	○	○	○
光驱	×	○	○	○	○	○
触控模块	×	○	○	○	○	○
电源	×	○	○	○	○	○
电池	×	○	○	○	○	○

本表格依据 SJ/T 11364 的规定编制。

○：表示该有毒有害物质在该部件所有均质材料中的含量均在 GB/T 26572标准规定的限量要求以下。

×：表示该有害物质的某一均质材料超出了GB/T 26572的限量要求，然而该部件

仍符合欧盟指令2011/65/EU 的规范。

备注：

- 一、此产品所标示之环保使用期限，系指在一般正常使用状况下。
- 二、上述部件物质中央处理器、内存、硬盘、光驱、电源为选购品。
- 三、上述部件物质液晶模块、触控模块仅一体机产品适用。

Hazardous and Toxic Materials List

AAEON System

QO4-381 Rev.A0

Component Name	Hazardous or Toxic Materials or Elements					
	Lead (Pb)	Mercury (Hg)	Cadmium (Cd)	Hexavalent Chromium (Cr(VI))	Polybrominated biphenyls (PBBS)	Polybrominated diphenyl ethers (PBDES)
PCB and Components	X	O	O	O	O	O
Wires & Connectors for Ext.Connections	X	O	O	O	O	O
Chassis	O	O	O	O	O	O
CPU & RAM	X	O	O	O	O	O
HDD Drive	X	O	O	O	O	O
LCD Module	X	X	O	O	O	O
Optical Drive	X	O	O	O	O	O
Touch Control Module	X	O	O	O	O	O
PSU	X	O	O	O	O	O
Battery	X	O	O	O	O	O

This form is prepared in compliance with the provisions of SJ/T 11364.

O: The level of toxic or hazardous materials present in this component and its parts is below the limit specified by GB/T 26572.

X: The level of toxic of hazardous materials present in the component exceed the limits specified by GB/T 26572, but is still in compliance with EU Directive 2011/65/EU (RoHS 2).

Notes:

1. The Environment Friendly Use Period indicated by labelling on this product is applicable only to use under normal conditions.
2. Individual components including the CPU, RAM/memory, HDD, optical drive, and PSU are optional.
3. LCD Module and Touch Control Module only applies to certain products which feature these components.

Table of Contents

Chapter 1 - Product Specifications	1
1.1 Specifications.....	2
Chapter 2 – Hardware Information	4
2.1 BOXER-6643-TGU Dimensions.....	5
2.2 Jumpers and Connectors	9
2.3 List of Jumpers	11
2.3.1 Setting Jumpers.....	11
2.3.2 Clear CMOS Jumper (JP1)	12
2.3.3 Auto-Power Button Selection (JP3).....	12
2.3.4 Mini-Card Mode Selection (JP4).....	12
2.4 List of Connectors	13
2.4.1 Dual HDMI Port (CN1).....	14
2.4.2 RJ-45 LAN Port (CN2, 3)	16
2.4.3 Remote Button Connector (CN4).....	17
2.4.4 COM Connector RS232/RS422/RS485 (CN9, 10).....	17
2.4.5 COM Port (Wafer Box, Optional) (CN13, 14)	18
2.4.6 M.2 Connector M-Key 2280 (CN15).....	19
2.4.7 Dual USB3.2 Gen 2 Ports (CN16, 17)	22
2.4.8 Audio Box Connector (CN23)	23
2.4.9 SATA Connector (CN26)	24
2.4.10 USB2.0 Wafer Box (CN27, 28)	25
2.4.11 Digital IO Port (CN31)	26
2.4.12 Debug Card Connector (CN34).....	27
2.4.13 Mini Card Slot (Full-Sized) (CN35)	28
2.4.14 SIM Slot (CN36, CN58)	30
2.4.15 M.2 Connector B-Key 3052 (CN40).....	31

2.5	Memory RAM Module Installation	34
2.6	Hardware Installation.....	35
2.6.1	2.5" SATA Drive Installation.....	35
2.6.2	Expansion Module Installation	36
Chapter 3 - AMI BIOS Setup.....		37
3.1	System Test and Initialization	38
3.2	AMI BIOS Setup.....	39
3.3	Setup Submenu: Main.....	40
3.4	Setup Submenu: Advanced	41
3.4.1	Trusted Computing.....	42
3.4.2	CPU Configuration	44
3.4.3	PCH-FW Configuration.....	46
3.4.3.1	Firmware Update Configuration.....	47
3.4.3.2	PTT Configuration	48
3.4.4	SATA Configuration	49
3.4.5	NVMe Configuration.....	50
3.4.6	USB Configuration.....	51
3.4.7	Hardware Monitor	52
3.4.8	SIO Configuration.....	53
3.4.8.1	Serial Port 1 Configuration	54
3.4.8.2	Serial Port 2 Configuration	55
3.4.8.3	Serial Port 3 Configuration	56
3.4.8.4	Serial Port 4 Configuration	57
3.4.9	Power Management.....	58
3.4.10	Digital IO Port Configuration	59
3.5	Setup Submenu: Chipset.....	61
3.5.1	System Agent (SA) Configuration	62
3.5.2	PCH-IO Configuration	64

3.6	Setup Submenu: Security	65
3.6.1	Secure Boot.....	66
3.6.1.1	Key Management.....	67
3.7	Setup Submenu: Boot.....	69
3.8	Setup Submenu: Save & Exit	70
Chapter 4 – Drivers Installation		71
4.1	Drivers Download and Installation.....	72
Appendix A - I/O Information.....		74
A.1	I/O Address Map.....	75
A.2	IRQ Mapping Chart	78
A.3	Memory Address Map	87

Chapter 1

Product Specifications

1.1 Specifications

System

CPU	Intel® Core™ i7-1185G7E Intel® Core™ i5-1145G7E Intel® Core™ i3-1115G4E
Chipset	Intel® SoC
System Memory	DDR4 SO-DIMM x 2, up to 64GB
Display Interface	HDMI 2.0 x 2
Storage Device	2.5" SATA SSD/HDD bay x 1 M.2 2280 for NVMe SSD (PCIe Gen 4)
Ethernet	Intel® i219 x 1 Intel® i225 x 1
I/O	HDMI x 2 RJ-45 x 1 for 1Gbps LAN (Intel® i219) RJ-45 x 1 for 2.5Gbps LAN (Intel® i225) USB3.2 Gen 2 x 3 USB2.0 x 1 DB-9 x 2 for RS-232/422/485 DB-9 x1 for 8-bit DIO Line out x 1 3-pin 9~36V Power Input x 1 Power Button x 1 Remote Power Switch x 1
Expansion	M.2 3052 B Key x 1 for 5G module Full-Size Mini Card x1 w/ SIM slot (mSATA/PCIe set by jumper, default PCIe)
Indicator	System/ Storage
Watchdog Timer	1 – 255 second/minute system reset
OS Support	Windows® 10 64-bit Ubuntu 20.04.2

Power Supply

Power Requirement	3-pin DC Input 9~36V
-------------------	----------------------

Mechanical

Mounting	Wall-mount
Dimensions (W x H x D)	7.87" x 5.63" x 1.75" (200mm x 143mm x 44.5mm) without bracket
Gross Weight	3.3 lbs. (1.5 kg)
Net Weight	4.4 lbs. (2.0 kg)

Environmental

Operating Temperature	-4°F ~ 140°F (-20°C ~ 60°C) with 0.5 m/s airflow
Storage Temperature	-40°F ~ 176°F (-40°C ~ 80°C)
Storage Humidity	5 ~ 95% @ 40°C, non-condensing
Anti-Vibration	2 Grms/ 5 ~ 500Hz/ operation – with SSD
Anti-Shock	Half sine, 50G/ 11ms – with SSD
Certification	CE, FCC Class A, UKCA

Chapter 2

Hardware Information

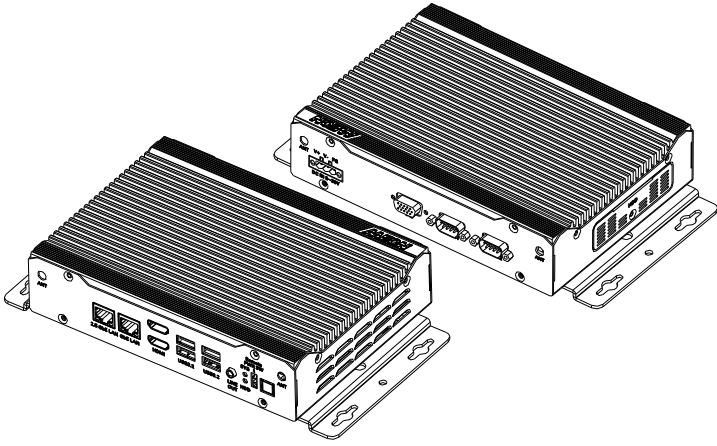

Board

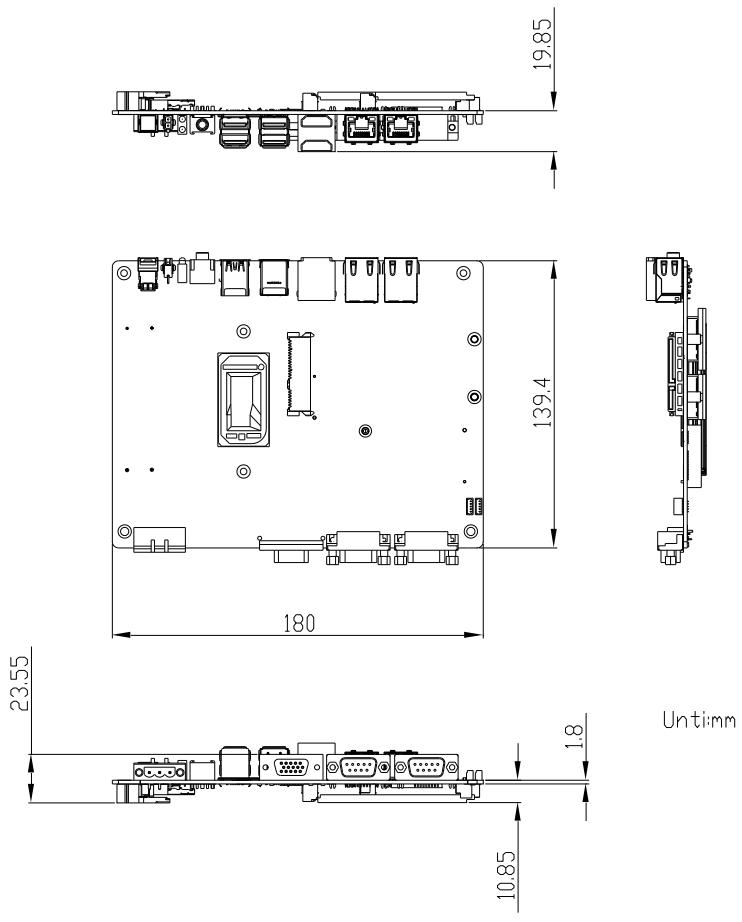

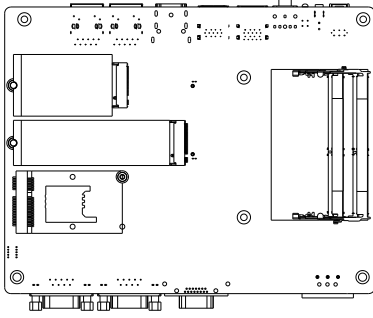

2.2 Jumpers and Connectors

Top

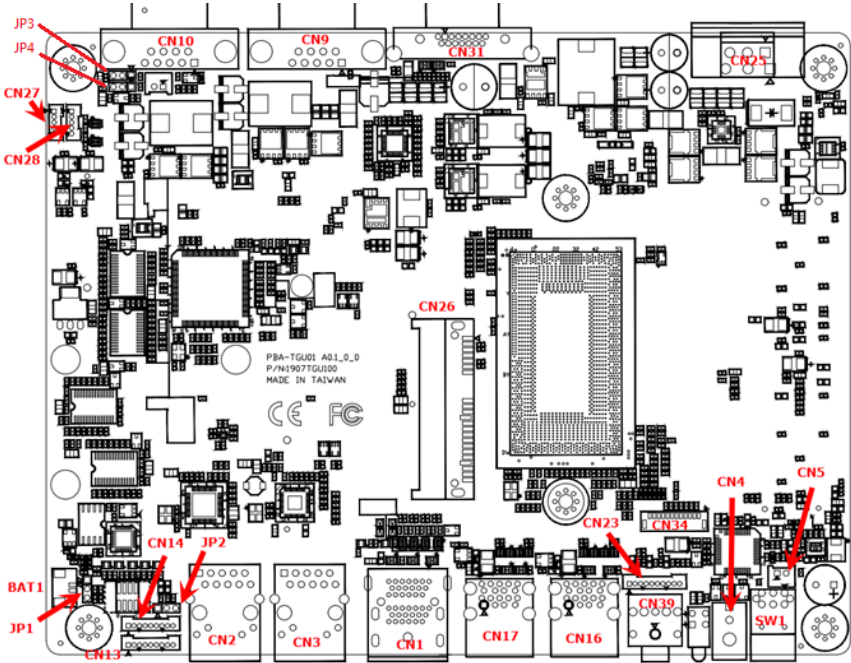

Bottom

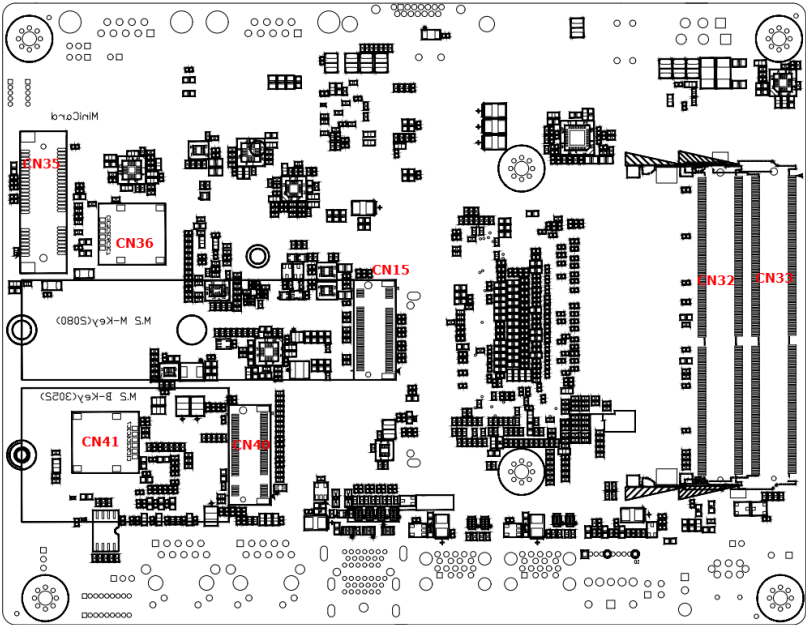

2.3 List of Jumpers

Please refer to the table below for all of the system's jumpers that you can configure for your application.

Label	Function
JP1	Clear CMOS Jumper
JP3	Auto-Power Button Selection (ATX/AT)
JP4	Mini Card mSATA/ PCIE selection

2.3.1 Setting Jumpers

The BOXER-6643-TGU comes with several jumpers which allow you to configure the system by either setting the jumper to "open" or "closed"; or by selecting certain pins. A closed jumper has two pins connected with a jumper clip, while an open jumper has no pins connected.

For jumpers with multiple pins, this guide uses "pins A-B" to notate which pins should be connected by a jumper clip. For example, "pins 1-2" means you should connect pins 1 and 2, while "pins 2-3" means you should connect pins 2 and 3.

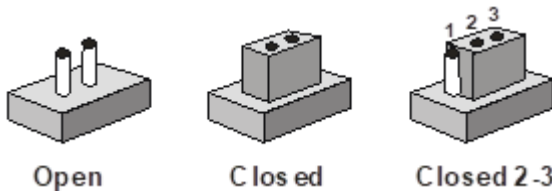

A pair of needle-nose pliers may be helpful when working with jumpers.

If you have any questions about how best to configure the system for your application, contact your AAEON representative or visit our website to talk with our support team.

2.3.2 Clear CMOS Jumper (JP1)

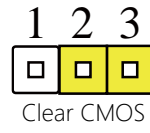
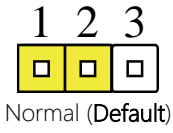

2.3.3 Auto-Power Button Selection (JP3)

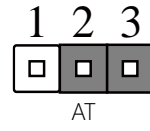
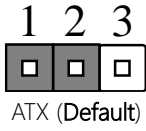

2.3.4 Mini-Card Mode Selection (JP4)

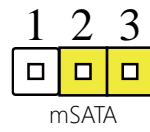
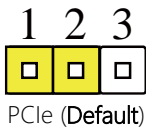

2.4 List of Connectors

Please refer to the table below for all of the system's connectors that you can configure for your application

Label	Function
CN1	Dual HDMI Port
CN2	LAN RJ-45 Connector 2.5Gbps
CN3	LAN RJ-45 Connector 1Gbps
CN4	Remote Button Connector
CN9	COM1 Connector RS232/RS422/RS485
CN10	COM2 Connector RS232/RS422/RS485
CN13	COM3 RS232/RS422/RS485 Box Connector
CN14	COM4 RS232/RS422/RS485 Box Connector
CN15	M.2 Slot Connector (M-Key 2280)
CN16	Dual USB3.2 Gen 2 Connector (Type A)
CN17	Dual USB3.2 Gen 2 Connector (Type A)
CN23	Audio Box Connector
CN25	Power Input Connector
CN26	SATA Connector (on-board type)
CN27	USB2.0 Box Connector
CN28	USB2.0 Box Connector
CN31	DIO Connector
CN32	SO-DIMM Channel A
CN33	SO-DIMM Channel B
CN34	Debug Card Connector (ESPI Bus)
CN35	Mini PCIe slot (Full-Size)
CN36	SIM Card Slot (for Mini Card)
CN38	Reset Switch Box Connector

Label	Function
CN39	Audio Line Out Connector
CN40	M.2 Slot Connector (B-Key 3052)
CN58	SIM Slot Connector (for B-Key)
SW1	Power Button with LED
BAT1	RTC Connector

2.4.1 Dual HDMI Port (CN1)

Note: Standard Specification

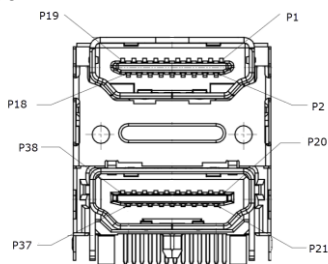

Pin	Signal	Signal Type	Signal Level
P1	HDMI1_DATA2_P	DIFF	
P2	GND	GND	
P3	HDMI1_DATA2_N	DIFF	
P4	HDMI1_DATA1_P	DIFF	
P5	GND	GND	
P6	HDMI1_DATA1_N	DIFF	
P7	HDMI1_DATA0_P		
P8	GND	GND	
P9	HDMI1_DATA0_n		
P10	HDMI1_CLK_P	DIFF	

Pin	Signal	Signal Type	Signal Level
P11	GND	GND	
P12	HDMI1_CLK_N	DIFF	
P13	CEC		3.3V
P14	NC		
P15	HDMI1_SCL		
P16	HDMI1_SDA		
P17	GND	GND	
P18	+V5S_HDMI_CON	PWR	5V
P19	HDMI1_HPD		5V
P20	HDMI2_DATA2_P		
P21	GND	GND	
P22	HDMI2_DATA2_N		
P23	HDMI2_DATA1_P		
P24	GND	GND	
P25	HDMI2_DATA1_N		
P26	HDMI2_DATA0_P		
P27	GND	GND	
P28	HDMI2_DATA0_N		
P29	HDMI2_CLK_P		
P30	GND	GND	
P31	HDMI2_CLK_N		
P32	CEC		3.3V
P33	NC		
P34	HDMI2_SCL		
P35	HDMI2_SDA		
P36	GND	GND	

Pin	Signal	Signal Type	Signal Level
P37	+V5S_HDMI_CON		5V
P38	HDMI2_HPD		5V

2.4.2 RJ-45 LAN Port (CN2, 3)

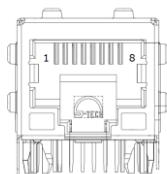

Pin	Signal	Signal Type	Signal Level
1	MDI0+	DIFF	
2	MDI0-	DIFF	
3	MDI1+	DIFF	
4	MDI2+	DIFF	
5	MDI2-	DIFF	
6	MDI1-	DIFF	
7	MDI3+	DIFF	
8	MDI3-	DIFF	

2.4.3 Remote Button Connector (CN4)

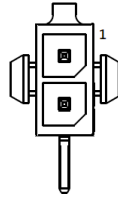

Note: Connects with male adapter EVER CONN 3016H-02 (2x1)

Pin	Signal	Signal Type	Signal Level
1	PWR_BUTTON	IN	
2	GND	GND	

2.4.4 COM Connector RS232/RS422/RS485 (CN9, 10)

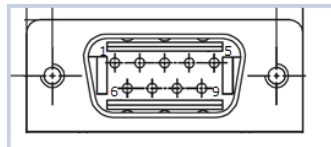

Pin	Pin Name	Signal	RS-422	RS-485
1	DCD	IN	TX-	D-
2	RX	IN	TX+	D+
3	TX	OUT	RX+	
4	DTR	OUT	RX-	
5	GND	GND		
6	DSR	IN		
7	RTS	OUT		
8	CTS	IN		
9	R11	IN		

2.4.5 COM Port (Wafer Box, Optional) (CN13, 14)

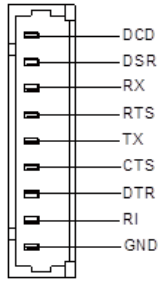

Pin	Pin Name	Signal	RS-422	RS-485
1	DCD	IN	TX-	D-
2	DSR	IN		
3	RX	IN	TX+	D+
4	RTS	OUT		
5	TX	OUT	RX+	
6	CTS	IN		
7	DTR	OUT	RX-	
8	RI	IN		
9	GND	GND		

2.4.6 M.2 Connector M-Key 2280 (CN15)

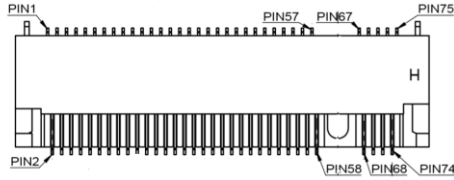

Pin	Signal	Signal Type	Signal Level
1	GND	GND	
2	+3.3V	PWR	+3.3V
3	GND	GND	
4	+3.3V	PWR	+3.3V
5	PCIE_RXN0	IN	
6	CARD_PWR_OFF_N	OUT	+3.3V
7	PCIE_RXP0	IN	
8	NC		
9	GND	GND	
10	NC		
11	PCIE_TXN0	OUT	
12	+3.3V	PWR	+3.3V
13	PCIE_TXP0	OUT	
14	+3.3V	PWR	+3.3V
15	GND	PWR	
16	+3.3V	PWR	+3.3V
17	PCIE_RXN1	IN	
18	+3.3V	PWR	+3.3V
19	PCIE_RXP1	IN	

Pin	Signal	Signal Type	Signal Level
20	NC		
21	GND	PWR	
22	NC		
23	PCIE_TXN1	OUT	
24	NC		
25	PCIE_TXP1	OUT	
26	NC		
27	GND	PWR	
28	NC		
29	PCIE_RXN2	IN	
30	NC		
31	PCIE_RXP2	IN	
32	NC		
33	GND	GND	
34	NC		
35	PCIE_TXN2	OUT	
36	NC		
37	PCIE_TXP2	OUT	
38	DEVSLP	IN	+3.3V
39	GND	GND	
40	SMB_CLK_M2		+1.8V
41	PCIE_RXP3	IN	
42	SMB_DATA_M2		+1.8V
43	PCIE_RXN3	IN	
44	NC		
45	GND	GND	

Pin	Signal	Signal Type	Signal Level
46	NC		
47	PCIE_TXN3	OUT	
48	NC		
49	PCIE_TXP3	OUT	
50	RESET#	IN	+3.3V
51	GND	PWR	
52	CLKREQ#	OUT	+3.3V
53	PCIE_M.2_CLK#	OUT	
54	WAKE#	OUT	+3.3V
55	PCIE_M.2_CLK	OUT	
56	NC		
57	GND	GND	
58	NC		
KEY			
67	NC		
68	NC		
69	NC		
70	+3.3V	PWR	+3.3V
71	GND	GND	
72	+3.3V	PWR	+3.3V
73	GND	GND	
74	+3.3V	PWR	+3.3V
75	GND	GND	

2.4.7 Dual USB3.2 Gen 2 Ports (CN16, 17)

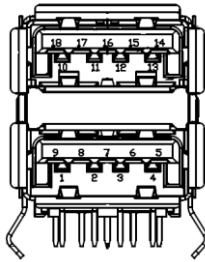

Pin	Signal	Signal Type	Signal Level
1	+5VSB	PWR	+5V
2	USB_D-	DIFF	
3	USB_D+	DIFF	
4	GND	GND	
5	USB3_RX_N	DIFF	
6	USB3_RX_P	DIFF	
7	GND	GND	
8	USB3_TX_N	DIFF	
9	USB3_TX_P	DIFF	
10	+5VSB	PWR	+5V
11	USB_D-	DIFF	
12	USB_D+	DIFF	
13	GND	GND	
14	USB3_RX_N	DIFF	
15	USB3_RX_P	DIFF	
16	GND	GND	
17	USB3_TX_N	DIFF	

Pin	Signal	Signal Type	Signal Level
18	USB3_TX_P	DIFF	

2.4.8 Audio Box Connector (CN23)

Note: 10P pitch:1.25mm

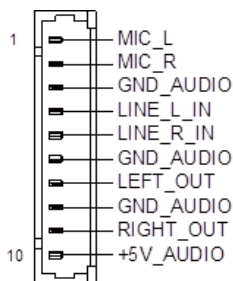

Pin	Signal	Signal Type	Signal Level
1	MIC_L	IN	
2	MIC_R	IN	
3	GND_AUDIO	GND	
4	LINE_L_IN	IN	
5	LINE_R_IN	IN	
6	GND_AUDIO	GND	
7	LEFT_OUT	OUT	
8	GND_AUDIO	GND	
9	RIGHT_OUT	OUT	
10	+5V_AUDIO	PWR	+5V

2.4.9 SATA Connector (CN26)

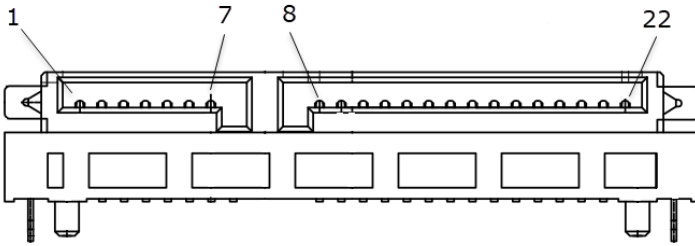

Pin	Signal	Signal Type	Signal Level
1	GND	GND	
2	SATA_TX+	DIFF	
3	SATA_TX-	DIFF	
4	GND	GND	
5	SATA_RX-	DIFF	
6	SATA_RX+	DIFF	
7	GND	GND	
8	+V3.3S	PWR	3.3V
9	+V3.3S	PWR	3.3V
10	+V3.3S	PWR	3.3V
11	GND	GND	
12	GND	GND	
13	GND	GND	
14	+V5S	PWR	5V
15	+V5S	PWR	5V
16	+V5S	PWR	5V

Pin	Signal	Signal Type	Signal Level
17	GND	GND	
18	NC		
19	GND	GND	
20	+V12S	PWR	12V
21	+V12S	PWR	12V
22	+V12S	PWR	12V

2.4.10 USB2.0 Wafer Box (CN27, 28)

Note: 5P Pitch: 1.25mm

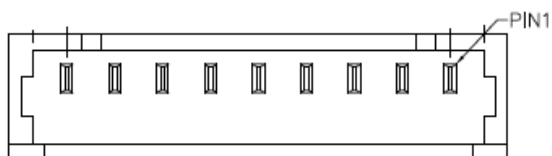

Pin	Signal	Signal Type	Signal Level
1	+5V	GND	+5V
2	USBD-	DIFF	
3	USBD+	DIFF	
4	GND	GND	
5	GND	GND	

2.4.11 Digital IO Port (CN31)

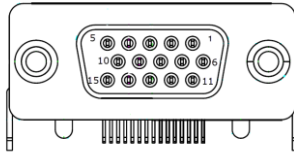

Pin	Signal	Signal Type	Signal Level
1	DIO0	I/O	+5V
2	DIO1	I/O	+5V
3	DIO2	I/O	+5V
4	DIO3	I/O	+5V
5	DIO4	I/O	+5V
6	DIO5	I/O	+5V
7	DIO6	I/O	+5V
8	DIO7	I/O	+5V
9	GND	GND	
10	+5V	PWR	+5V
11	NC		
12	NC		
13	NC		
14	NC		
15	NC		

2.4.12 Debug Card Connector (CN34)

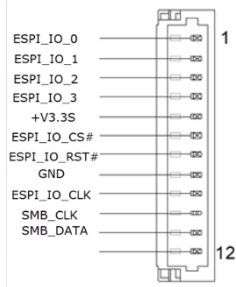

Pin	Signal	Signal Type	Signal Level
1	ESPI_IO_0	I/O	+1.8V
2	ESPI_IO_1	I/O	+1.8V
3	ESPI_IO_2	I/O	+1.8V
4	ESPI_IO_3	I/O	+1.8V
5	+3.3V	PWR	+3.3V
6	ESPI_IO_CS#	IN	
7	ESPI_IO_RST#	IN	
8	GND	GND	
9	ESPI_IO_LCLK	IN	
10	SMCLK	IN	
11	SMDAT	I/O	
12	NC		

2.4.13 Mini Card Slot (Full-Sized) (CN35)

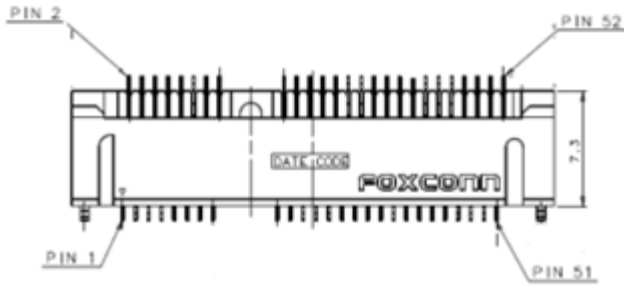

Pin	Signal	Signal Type	Signal Level
1	PCIE_WAKE#	IN	
2	+3.3V	PWR	+3.3V
3	NC		
4	GND	GND	
5	NC		
6	+1.5V	PWR	+1.5V
7	PCIE_CLK_REQ#	IN	
8	UIM_PWR	PWR	
9	GND	GND	
10	UIM_DATA	I/O	
11	PCIE_REF_CLK-	DIFF	
12	UIM_CLK	IN	
13	PCIE_REF_CLK+	DIFF	
14	UIM_RESET	IN	
15	GND	GND	
16	UIM_VPP	PWR	
17	NC		

Pin	Signal	Signal Type	Signal Level
18	GND	GND	
19	NC		
20	W_DISABLE#	OUT	+3.3V
21	GND	GND	
22	PCIE_RST#	OUT	+3.3V
23	PCIE_RX-	DIFF	
24	+3.3VSB	PWR	+3.3V
25	PCIE_RX+	DIFF	
26	GND	GND	
27	GND	GND	
28	+1.5V	PWR	+1.5V
29	GND	GND	
30	SMB_CLK	I/O	+3.3V
31	PCIE_TX-	DIFF	
32	SMB_DATA	I/O	+3.3V
33	PCIE_TX+	DIFF	
34	GND	GND	
35	GND	GND	
36	USB_D-	DIFF	
37	GND	GND	
38	USB_D+	DIFF	
39	+3.3VSB	PWR	+3.3V
40	GND	GND	
41	+3.3VSB	PWR	+3.3V
42	NC		
43	GND	GND	

Pin	Signal	Signal Type	Signal Level
44	NC		
45	MINICARD_SATA_PCIE_DET		+3.3V
46	NC		
47	NC		
48	+1.5V	PWR	+1.5V
49	NC		
50	GND	GND	
51	NC		
52	+3.3VSB	PWR	+3.3V

2.4.14 SIM Slot (CN36, CN58)

Pin	Signal	Signal Type	Signal Level
1	UIM_PWR	PWR	
2	UIM_RST	IN	
3	UIM_CLK	IN	
4	GND	GND	
5	UIM_VPP	PWR	
6	UIM_DATA	I/O	

2.4.15 M.2 Connector B-Key 3052 (CN40)

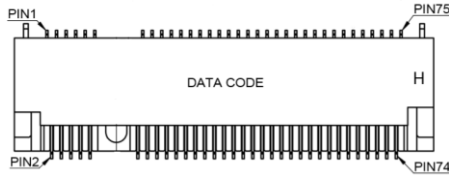

Pin	Signal	Signal Type	Signal Level
1	NC		
2	+3.3V	PWR	+3.3V
3	GND	GND	
4	+3.3V	PWR	+3.3V
5	GND	GND	
6	CARD_PWR_OFF_N	OUT	+3.3V
7	USB_2.0_P		
8	W_DISABLE	IN	+3.3V
9	USB_2.0_N		
10	NC		
11	GND	GND	
KEY			
20	NC		
21	NC		
22	NC		
23	NC		
24	NC		
25	NC		
26	NC		

Pin	Signal	Signal Type	Signal Level
27	GND	GND	
28	NC		
29	USB3_RXN		
30	UIM_RST		
31	USB3_RXP		
32	UIM_CLK		
33	GND	GND	
34	UIM_DATA		
35	USB3_TXN		
36	UIM_PWR		
37	USB3_TXP		
38	NC		
39	GND	GND	
40	NC		
41	PCIE_RXN		
42	NC		
43	PCIE_RXP		
44	NC		
45	GND	GND	
46	NC		
47	PCIE_TXN		
48	NC		
49	PCIE_TXP		
50	RESET#	IN	+3.3V
51	GND	PWR	
52	CLKREQ#	OUT	+3.3V

Pin	Signal	Signal Type	Signal Level
53	PCIE_M.2_CLK#	OUT	
54	WAKE#	OUT	+3.3V
55	PCIE_M.2_CLK	OUT	
56	NC		
57	GND	GND	
58	NC		
59	NC		
60	NC		
61	NC		
62	NC		
63	NC		
64	NC		
65	NC		
66	NC		
67	RESET#		
68	SUSCLK		
69	NC		
70	+3.3V	PWR	+3.3V
71	GND	GND	
72	+3.3V	PWR	+3.3V
73	GND	GND	
74	+3.3V	PWR	+3.3V
75	GND	GND	

2.5 Memory RAM Module Installation

Before installing the RAM, ensure the system is powered down and disconnect the power cord from the system. Make sure you have the RAM module(s) ready to install. See Chapter 1 for RAM requirements and specifications.

On the bottom of the system, remove the DIMM Cover. Attach thermal pads to the DDR4 modules as shown in the figure below. Insert the modules into the memory slots. Replace the DIMM Cover and ensure it is properly secured.

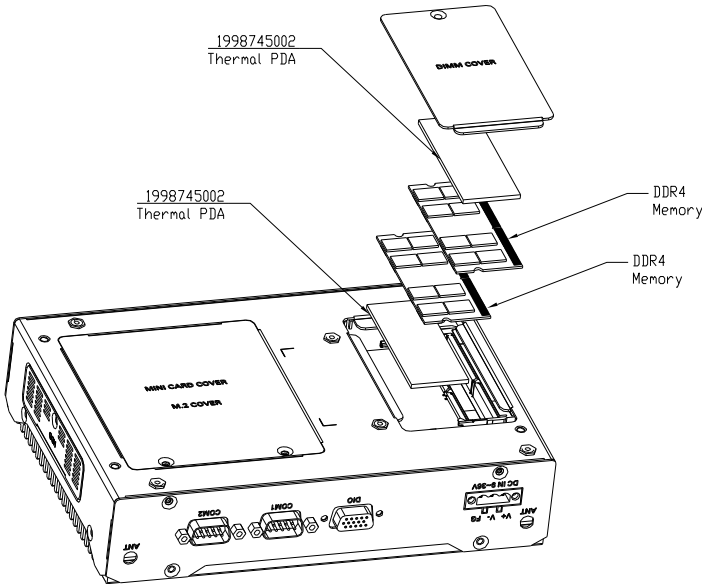

2.6 Hardware Installation

2.6.1 2.5" SATA Drive Installation

Before installing the SATA Drive, ensure the system is powered down and disconnect the power cord from the system. Make sure you have the SATA Drive ready to install. See Chapter 1 for SATA drive specifications for compatibility.

Access the SATA Drive tray by removing it via the side panel. Insert the SATA drive into the tray and secure with four screws. Make sure the SATA drive lines up properly with the SATA connector on the board. Reinsert the SATA Drive tray, ensuring it closes flush. DO NOT force the tray shut. If it will not shut correctly, check that the SATA drive is properly oriented to line up with the connector.

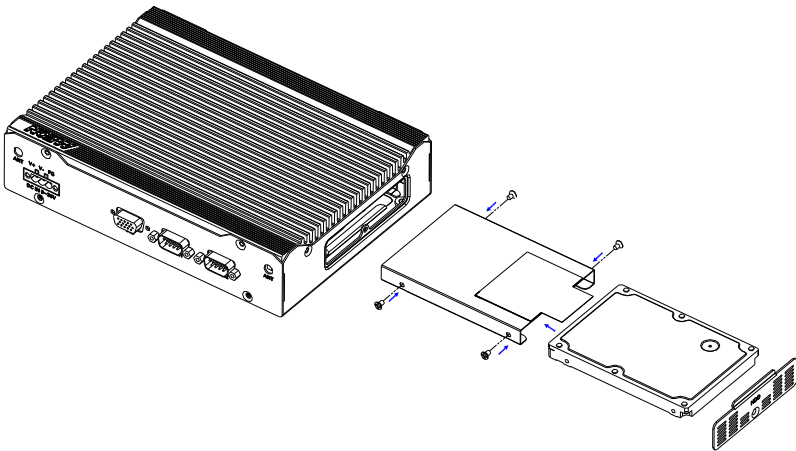

2.6.2 Expansion Module Installation

Before installing your expansion module (Mini Card/M.2), ensure the system is powered down and disconnect the power cord from the system. Make sure you have the expansion module ready to install. See Chapter 1 for expansion module specifications for compatibility.

Turn the BOXER-6643-TGU system over so the bottom is facing up. Remove the two retaining screws securing the bottom access panel. Install each module by first inserting at an angle (approx 30°) then gently pressing down and securing with a retaining screw. Refer to the image below or Chapter 2.2 for which slot to insert your Mini PCIe, M.2 2280 or M.2 3052 module.

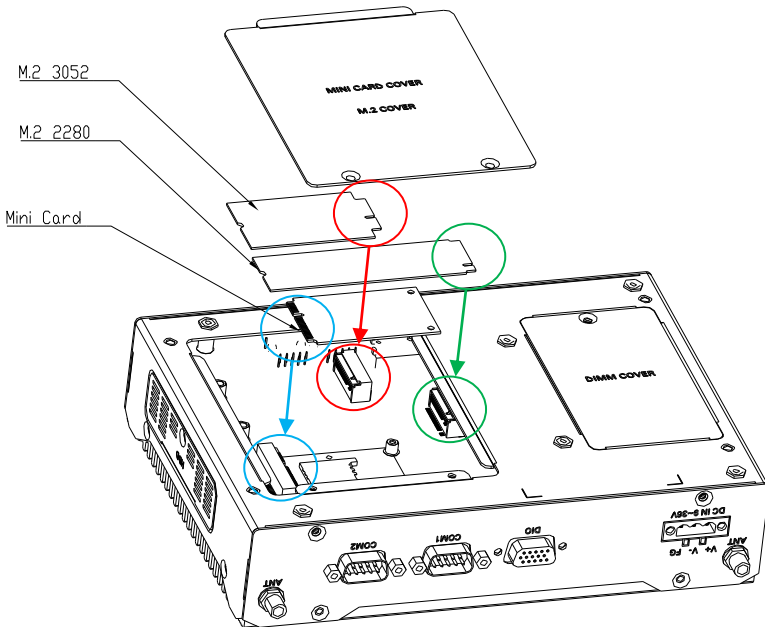

Chapter 3

AMI BIOS Setup

3.1 System Test and Initialization

The system uses certain routines to perform testing and initialization during the boot up sequence. If an error, fatal or non-fatal, is encountered, the system will output a few short beeps or an error message. The board can usually continue the boot up sequence with non-fatal errors.

The system configuration verification routines check the current system configuration against the values stored in the CMOS memory. If they do not match, an error message will be output, and the BIOS setup program will need to be run to set the configuration information in memory.

There are three situations in which the CMOS settings will need to be set or changed:

- Starting the system for the first time
- The system hardware has been changed
- The system configuration was reset by the Clear CMOS jumper
- The CMOS memory has lost power and the configuration information is erased

The system's CMOS memory uses a backup battery for data retention. The battery must be replaced when it runs down.

3.2 AMI BIOS Setup

The AMI BIOS ROM has a pre-installed Setup program that allows users to modify basic system configurations, which is stored in the battery-backed CMOS RAM and BIOS NVRAM so that the information is retained when the power is turned off.

To enter BIOS Setup, power on the computer and press or <ESC> immediately during boot up.

The function for each interface can be found below.

Main – Date and time can be set here. Press <Tab> to switch between date elements

Advanced – Access advanced hardware settings and options

Chipset – Chipset settings and options

Security – Set admin password and Secure Boot options

Boot – Adjust settings including boot priority and Quiet Boot

Save & Exit – Save your changes and exit the program

3.3 Setup Submenu: Main

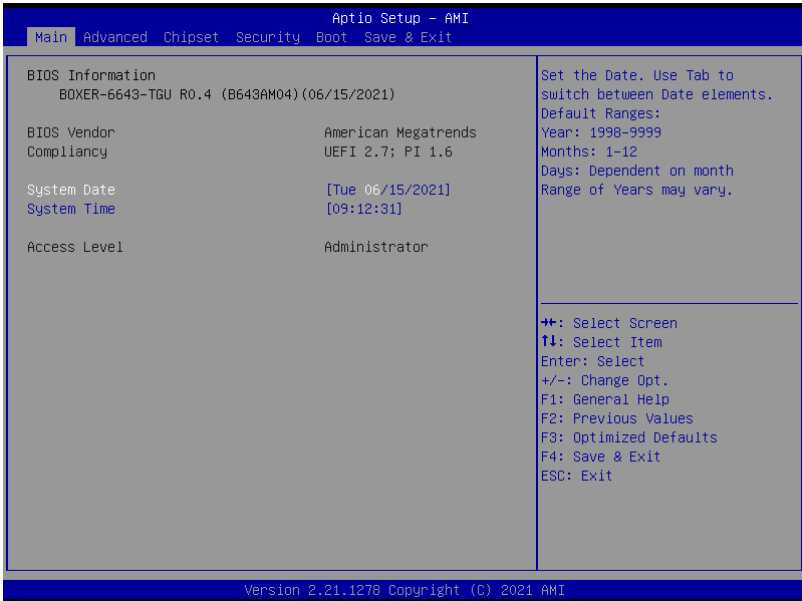

3.4 Setup Submenu: Advanced

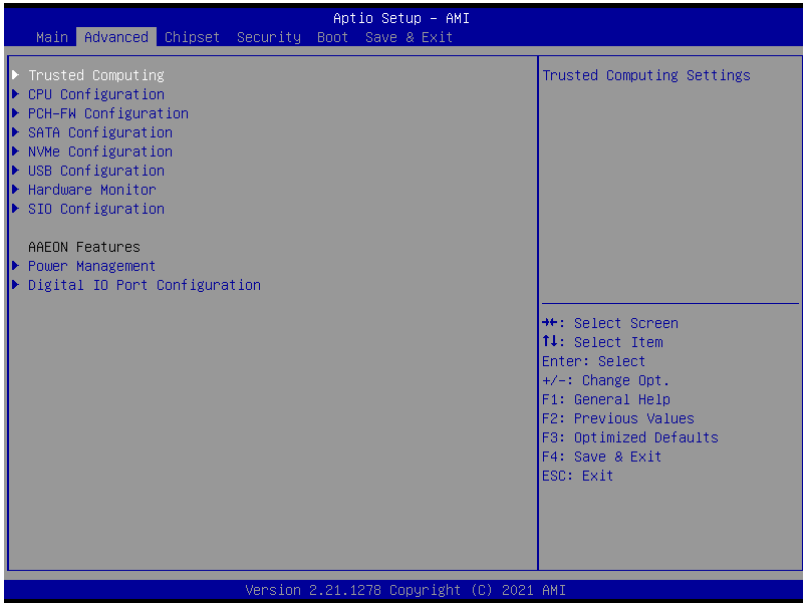

3.4.1 Trusted Computing

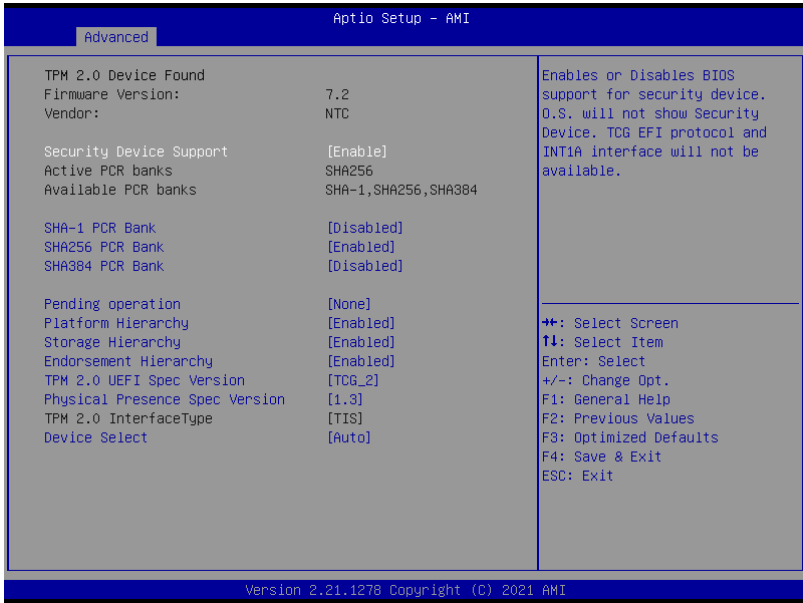

Options Summary		
Security Device Support	Disable	
	Enable	Optimal Default, Failsafe Default
Enables or Disables BIOS support for security device. O.S. will not show Security Device. TCG EFI protocol and INT1A interface will not be available.		
SHA-1 PCR Bank	Disable	Optimal Default, Failsafe Default
	Enable	
Enable or Disable SHA-1 PCR Bank.		
SHA256 PCR Bank	Disable	
	Enable	Optimal Default, Failsafe Default
Enable or Disable SHA-256 PCR Bank.		
SHA384 PCR Bank	Disable	Optimal Default, Failsafe Default
	Enable	
Enable or Disable SHA-384 PCR Bank.		

Table Continues on Next Page...

Options Summary		
Pending operation	None	Optimal Default, Failsafe Default
	TPM Clear	
Schedule an Operation for the Security Device. NOTE: Your Computer will reboot during restart in order to change state of Security Device.		
Platform Hierarchy	Disable	
	Enable	Optimal Default, Failsafe Default
Enable or Disable Platform Hierarchy		
Storage Hierarchy	Disable	
	Enable	Optimal Default, Failsafe Default
Enable or Disable Storage Hierarchy		
Endorsement Hierarchy	Disable	
	Enable	Optimal Default, Failsafe Default
Enable or Disable Endorsement Hierarchy		
TPM2.0 UEFI Spec	TCG_1_2	
Version	TCG_2	Optimal Default, Failsafe Default
Select the TCG2 Spec Version Support, TCG_1_2: Compatible mode for Win8/Win10, TCG_2: Support new TCG2 protocol and event format for Win10 or later.		
Physical Presence Spec	1.2	
Version	1.3	Optimal Default, Failsafe Default
Select to Tell O.S. to support PPI Spec Version 1.2 or 1.3. Note some HCK tests might not support 1.3.		
Device Select	TPM 1.2	
	TPM 2.0	
	Auto	Optimal Default, Failsafe Default
TPM 1.2 will restrict support to TPM 1.2 device TPM 2.0 will restrict support to TPM 2.0 devices Auto will support both with the default set to TPM 2.0 devices if not found, TPM 1.2 device will be enumerated.		

3.4.2 CPU Configuration

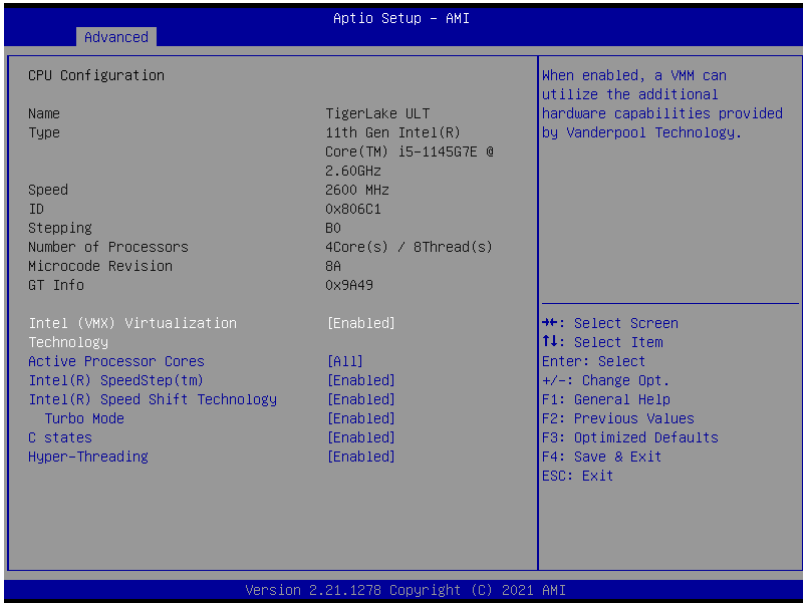

Options Summary		
Intel (VMX) Virtualization Technology	Disabled	
	Enabled	Optimal Default, Failsafe Default
When enabled, a VMM can utilize the additional hardware capabilities provided by Vanderpool Technology.		
Active Processor Cores	All	Optimal Default, Failsafe Default
	1	
Number of cores to enable in each processor package.		
Intel® SpeedStep™	Disabled	
	Enabled	Optimal Default, Failsafe Default
Allows more than two frequency ranges to be supported.		
Intel® Speed Shift Technology	Disabled	
	Enabled	Optimal Default, Failsafe Default
Enable/Disable Intel® Speed Shift Technology support. Enabling will expose the CPPC v2 interface to allow for hardware controlled P-states.		

Options Summary		
Turbo Mode	Disabled	
	Enabled	Optimal Default, Failsafe Default
Enable/Disable processor Turbo Mode (requires EMTTM enabled too). AUTO means enabled.		
C states	Disabled	
	Enabled	Optimal Default, Failsafe Default
Enable/Disable CPU Power Management. Allows CPU to go to C states when it's not 100% utilized.		
Hyper-Threading	Disabled	
	Enabled	Optimal Default, Failsafe Default
Enable or Disable Hyper-Threading Technology.		

3.4.3 PCH-FW Configuration

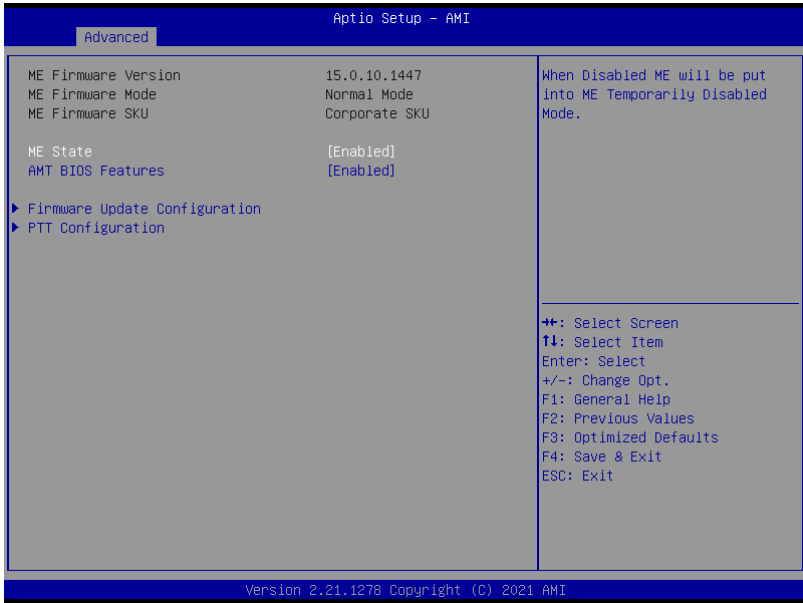

Options Summary		
ME State	Disabled	Optimal Default, Failsafe Default
	Enabled	
When Disabled ME will be put into ME Temporarily Disabled Mode.		
AMT BIOS Features	Disabled	Optimal Default, Failsafe Default
	Enabled	
When disabled AMT BIOS Features are no longer supported and user is no longer able to access MEBx Setup.		
Note:		
This option does not disable Manageability Features in FW.		

3.4.3.1 Firmware Update Configuration

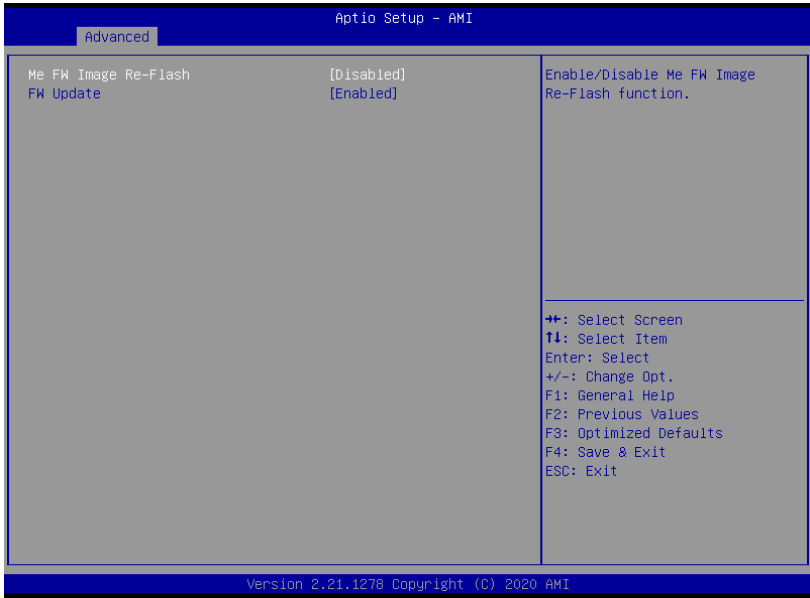

Options Summary		
ME FW Image Re-Flash	Disabled	Optimal Default; Failsafe Default
	Enabled	
Enable/Disable ME FW Image Re-Flash function.		
FW Update	Disabled	Optimal Default; Failsafe Default
	Enabled	
Enable/Disable ME FW Update function		

3.4.3.2 PTT Configuration



Options Summary

TPM Device Selection	dTPM	Optimal Default; Failsafe Default
	PTT	
<p>Selects TPM device: PTT or dTPM. PTT – Enables PTT in SkuMgr dTPM 1.2 – Disables PTT in SkuMgr Warning! PTT/dTPM will be disabled and all saved data will be lost.</p>		

3.4.4 SATA Configuration

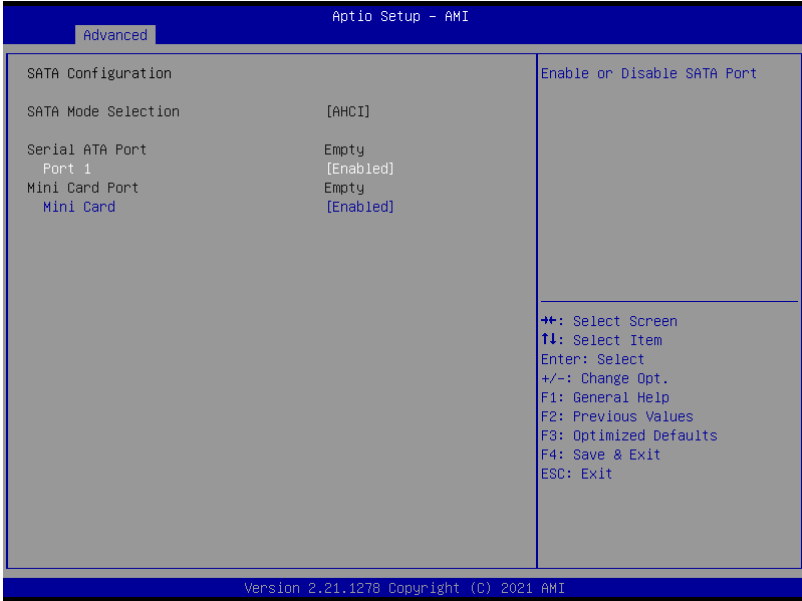

Options Summary		
Port 1	Disabled	
	Enabled	Optimal Default, Failsafe Default
Enable or Disable SATA Port.		
Mini Card	Disabled	
	Enabled	Optimal Default, Failsafe Default
Enable or Disable SATA Port.		

3.4.5 NVMe Configuration

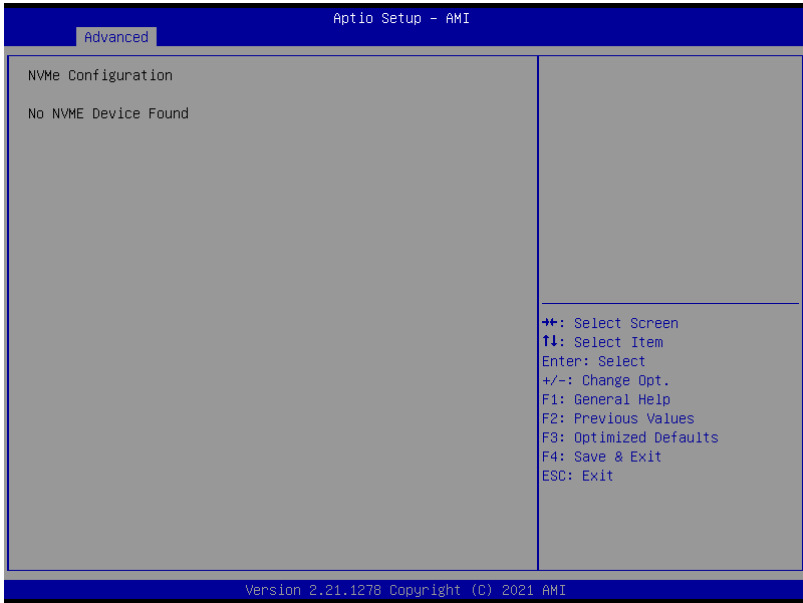

3.4.6 USB Configuration

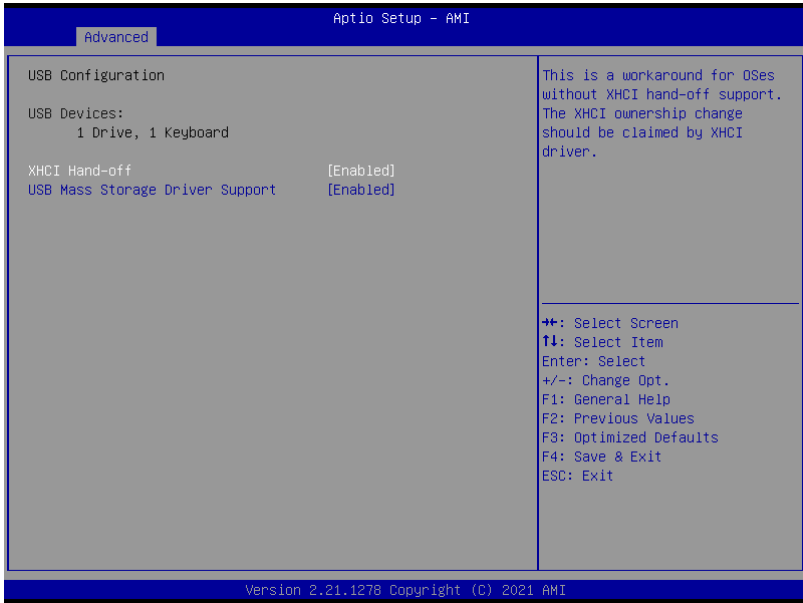

Options Summary		
XHCI Hand-off	Disabled	
	Enabled	Optimal Default, Failsafe Default
This is a workaround for OSes without XHCI hand-off support. The XHCI ownership change should be claimed by XHCI driver.		
USB Mass Storage Driver Support	Disabled	
	Enabled	Optimal Default, Failsafe Default
Enable/Disable USB Mass Storage Driver Support.		

3.4.7 Hardware Monitor

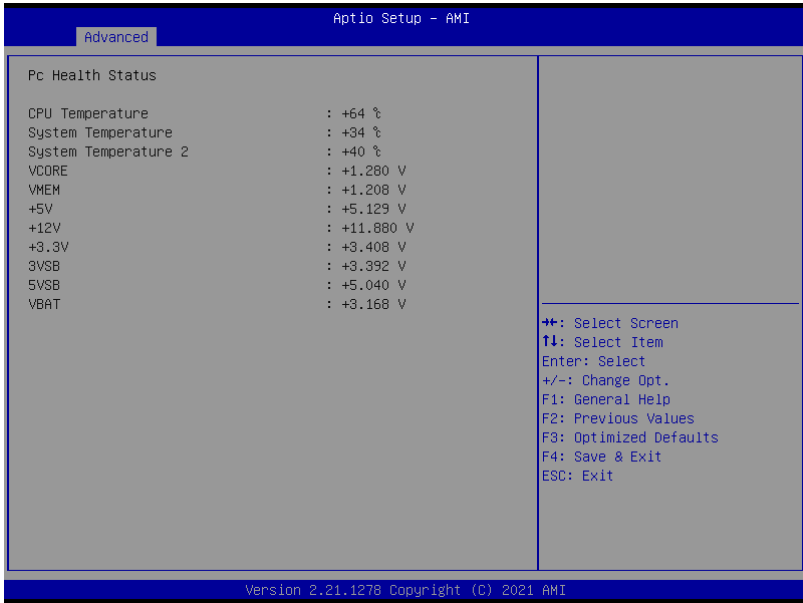

3.4.8 SIO Configuration



3.4.8.1 Serial Port 1 Configuration

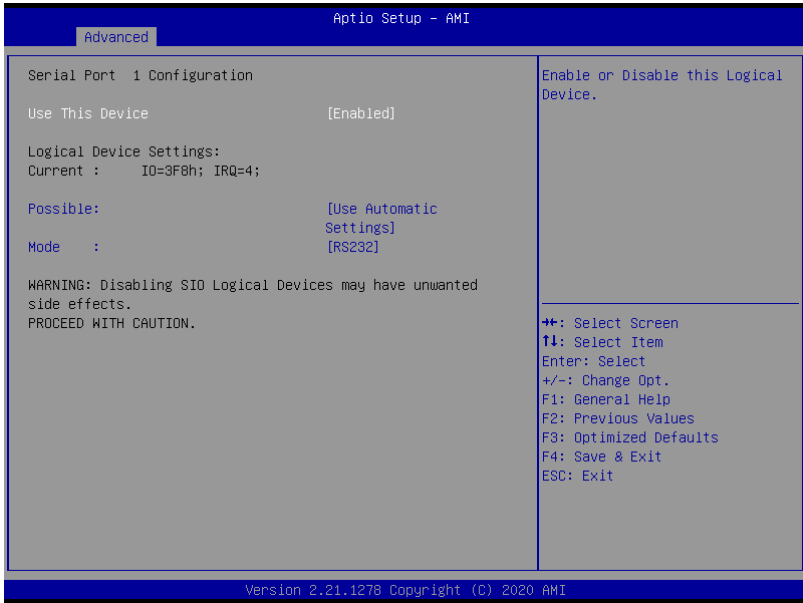

Options Summary		
Use This Device	Disabled	Optimal Default; Failsafe Default
	Enabled	
Enabled or Disabled this Logical Device.		
Possible	Use Automatic Setting	Optimal Default, Failsafe Default
	IO=3F8h; IRQ = 4;	
	IO=2F8h; IRQ = 3;	
Allows the user to change the device resource settings. New settings will be reflected on this setup page after system restarts.		
Mode	RS232	Optimal Default, Failsafe Default
	RS422	
	RS485	
UART RS232, 422, 485 selection.		

3.4.8.2 Serial Port 2 Configuration



Options Summary		
Use This Device	Disabled	Optimal Default; Failsafe Default
	Enabled	
Enabled or Disabled this Logical Device.		
Possible	Use Automatic Setting	Optimal Default, Failsafe Default
	IO=2F8h; IRQ = 3;	
	IO=3F8h; IRQ = 4;	
Allows the user to change the device resource settings. New settings will be reflected on this setup page after system restarts.		
Mode	RS232	Optimal Default, Failsafe Default
	RS422	
	RS485	
UART RS232, 422, 485 selection.		

3.4.8.3 Serial Port 3 Configuration

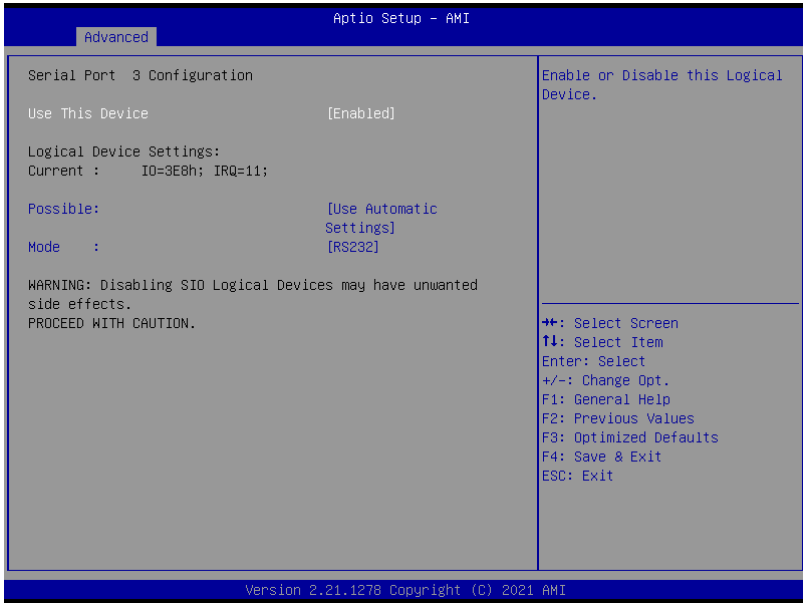

Options Summary		
Use This Device	Disabled	Optimal Default; Failsafe Default
	Enabled	
Enabled or Disabled this Logical Device.		
Possible	Use Automatic Setting	Optimal Default, Failsafe Default
	IO=3E8h; IRQ = 11;	
	IO=2E8h; IRQ = 11;	
Allows the user to change the device resource settings. New settings will be reflected on this setup page after system restarts.		
Mode	RS232	Optimal Default, Failsafe Default
	RS422	
	RS485	
UART RS232, 422, 485 selection.		

3.4.8.4 Serial Port 4 Configuration



Options Summary		
Use This Device	Disabled	Optimal Default; Failsafe Default
	Enabled	
Enabled or Disabled this Logical Device.		
Possible	Use Automatic Setting	Optimal Default, Failsafe Default
	IO=2E8h; IRQ = 11;	
	IO=3E8h; IRQ = 11;	
Allows the user to change the device resource settings. New settings will be reflected on this setup page after system restarts.		
Mode	RS232	Optimal Default, Failsafe Default
	RS422	
	RS485	
UART RS232, 422, 485 selection.		

3.4.9 Power Management

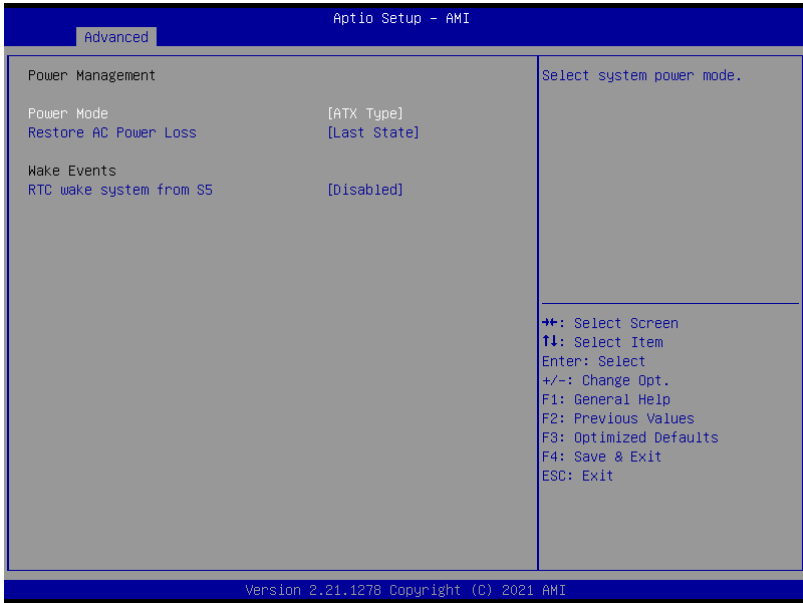

Options Summary		
Power Mode	ATX Type	Optimal Default, Failsafe Default
	AT Type	
Select power supply mode.		
Restore AC Power Loss	Last State	Optimal Default, Failsafe Default
	Always On	
	Always Off	
Select power state when power is re-applied after a power failure.		
RTC wake system from S5	Disabled	Optimal Default, Failsafe Default
	Fixed Time	
	Dynamic Time	
	Bypass	
Fixed Time: System will wake on the hour :: min :: sec specified.		
Dynamic Time: System will wake on the current time + Increase minutes(s).		
Bypass: BIOS will not control RTC wake function during system shutdown.		

3.4.10 Digital IO Port Configuration

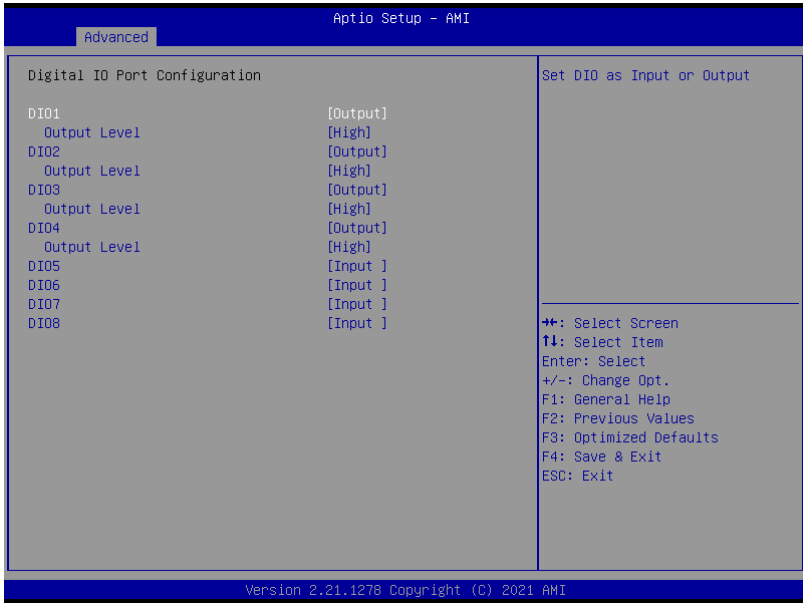

Options Summary		
DIO1	Output	Optimal Default, Failsafe Default
	Input	
Set DIO as Input or Output.		
Output Level	High	Optimal Default, Failsafe Default
	Low	
Set output level when DIO pin is output.		
DIO2	Output	Optimal Default, Failsafe Default
	Input	
Set DIO as Input or Output.		
Output Level	High	Optimal Default, Failsafe Default
	Low	
Set output level when DIO pin is output.		
DIO3	Output	Optimal Default, Failsafe Default
	Input	
Set DIO as Input or Output.		

Options Summary		
Output Level	High	Optimal Default, Failsafe Default
	Low	
Set output level when DIO pin is output.		
DIO4	Output	Optimal Default, Failsafe Default
	Input	
Set DIO as Input or Output.		
Output Level	High	Optimal Default, Failsafe Default
	Low	
Set output level when DIO pin is output.		
DIO5	Output	
	Input	Optimal Default, Failsafe Default
Set DIO as Input or Output.		
Output Level	High	Optimal Default, Failsafe Default
	Low	
Set output level when DIO pin is output.		
DIO6	Output	
	Input	Optimal Default, Failsafe Default
Set DIO as Input or Output.		
Output Level	High	Optimal Default, Failsafe Default
	Low	
Set output level when DIO pin is output.		
DIO7	Output	
	Input	Optimal Default, Failsafe Default
Set DIO as Input or Output.		
Output Level	High	Optimal Default, Failsafe Default
	Low	
Set output level when DIO pin is output.		
DIO8	Output	
	Input	Optimal Default, Failsafe Default
Set DIO as Input or Output.		
Output Level	High	Optimal Default, Failsafe Default
	Low	
Set output level when DIO pin is output.		

3.5 Setup Submenu: Chipset



3.5.1 System Agent (SA) Configuration

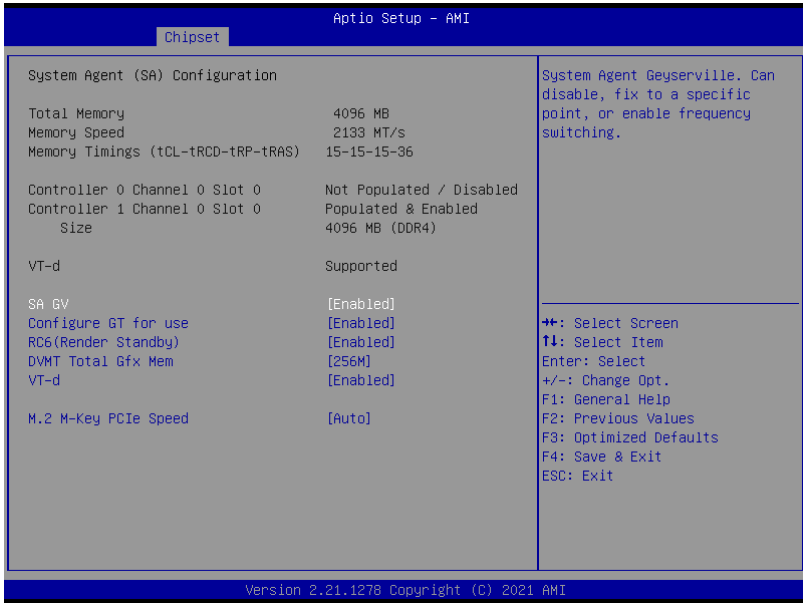

Options Summary		
SA GV	Disabled	Optimal Default, Failsafe Default
	Fixed Low	
	Fixed High	
	Enabled	
System Agent Geyserville. Fixed Low/High: SA GV disabled, MRC only runs tasks from Low or High point. SA GV will be disabled on DT/Halo CPUs, regardless of this setting.		
Configure GT for use	Enabled	Optimal Default, Failsafe Default
	Disabled	
Enable/Disable GT configuration in BIOS		
RC6(Render Standby)	Disabled	Optimal Default, Failsafe Default
	Enabled	
Check to enable render standby support.		

Table Continues on Next Page

Options Summary		
DVMT Total Gfx Mem	128M	Optimal Default, Failsafe Default
	256M	
	MAX	
Select DVMT5.0 Total Graphic Memory size used by the Internal Graphics Device.		
VT-d	Disabled	Optimal Default, Failsafe Default
	Enabled	
VT-d capability		
M.2 M-Key PCIe Speed	Auto	Optimal Default, Failsafe Default
	Gen1	
	Gen2	
	Gen3	
	Gen4	
Configure PCIe Speed		

3.5.2 PCH-IO Configuration

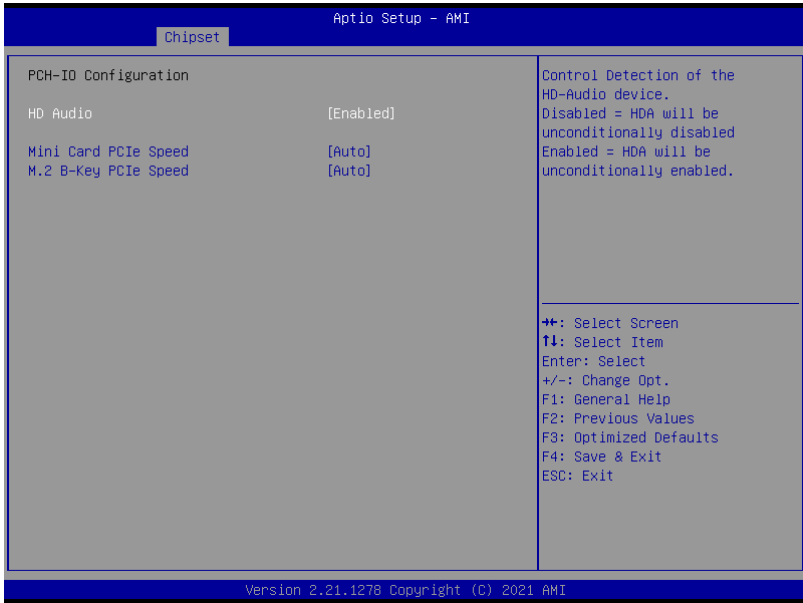

Options Summary

HD Audio	Enabled	Optimal Default, Failsafe Default
	Disabled	
Control the Detection of the Audio device. Disabled = HDA will be unconditionally disabled. Enabled = HDA will be unconditionally enabled.		
Mini Card PCIe Speed	Auto	Optimal Default, Failsafe Default
	Gen 1	
	Gen 2	
	Gen 3	
Configure PCIe Speed.		
M.2 B-Key PCIe Speed	Auto	Optimal Default, Failsafe Default
	Gen 1	
	Gen 2	
	Gen 3	
Configure PCIe Speed		

3.6 Setup Submenu: Security



Change User/Administrator Password

You can set an Administrator Password or User Password. An Administrator Password must be set before you can set a User Password. The password will be required during boot up, or when the user enters the Setup utility. A User Password does not provide access to many of the features in the Setup utility.

Select the password you wish to set, and press Enter. In the dialog box, enter your password (must be between 3 and 20 letters or numbers). Press Enter and retype your password to confirm. Press Enter again to set the password.

Removing the Password

Select the password you want to remove and enter the current password. At the next dialog box press Enter to disable password protection.

3.6.1 Secure Boot



Options Summary		
Secure Boot	Disable	Optimal Default, Failsafe Default
	Enable	
Secure Boot feature is Active if Secure Boot is Enabled, Platform Key (PK) is enrolled and the System mode is in User mode. The mode change requires platform reset.		
Secure Boot Mode	Standard	Optimal Default, Failsafe Default
	Custom	
Secure Boot Mode options: Standard or Custom. In Custom mode, Secure Boot Policy variables can be configured by a physically present user without full authentication.		
Restore Factory Keys		
Force system to user mode. Install factory default Secure Boot key databases		
Reset to Setup Mode		
Delete all Secure Boot key databases from NVRAM.		

3.6.1.1 Key Management

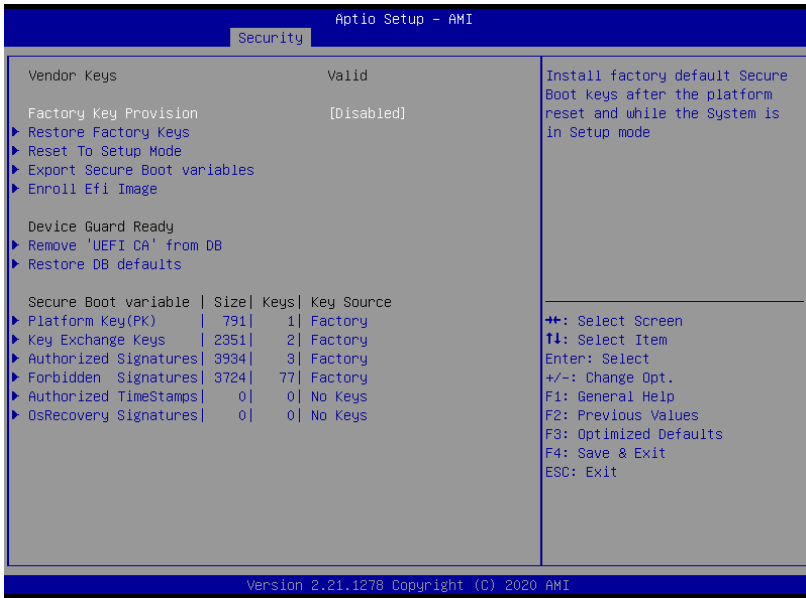

Options Summary

Provision Factory Defaults	Disabled	Optimal Default, Failsafe Default
	Enabled	
Install factory default Secure Boot keys after the platform reset and while the System is in Setup mode.		
Restore Factory Keys	Force system to user mode. Install factory default Secure Boot key databases.	
Reset to Setup Mode	Delete all Secure Boot key databases from NVRAM.	
Export Secure Boot Variables	Copy NVRAM content of Secure Boot variables to files in a root folder on a file system device	
Enroll EFI Image	Allow the image to run in Secure Boot mode. Enroll SHA256 hash of a PE image into Authorized Signature Database (db).	
Remove 'UEFI CA' from DB	Device Guard ready system must not list 'Microsoft UEFI CA' Certificate in Authorized Signature database (db)	
Restore DB defaults	Restore DB variable to factory defaults.	

Options Summary	
Save all Secure Boot Variables.	Save NVRAM content of Secure Boot policy variables to the files (EFI_SIGNATURE_LIST data format) in root folder on a target file system device.

Secure Boot Variables

Enroll Factory Defaults or load certificates from a file:

1. Public Key Certificate in:
 - a) EFI_SIGNATURE_LIST
 - b) EFI_CERT_X509 (DER encoded)
 - c) EFI_CERT_RSA2048 (bin)
 - d) EFI_CERT_SHA256,384,512
2. Authenticated UEFI Variable
3. EFI PE/COFF Image (SHA256)

Key Source:

Default, External, Mixed, Test

3.7 Setup Submenu: Boot

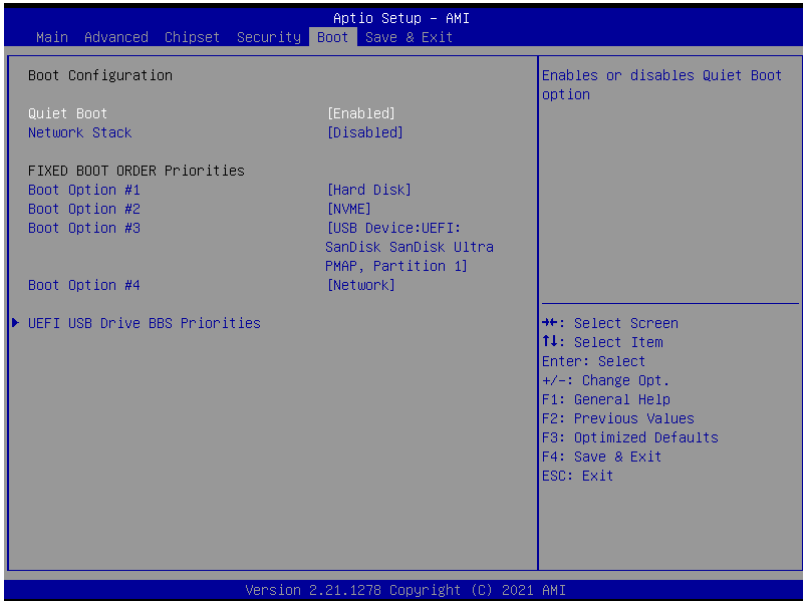

Options Summary		
Quiet Boot	Disabled	Optimal Default, Failsafe Default
	Enabled	
Enable / Disable Quiet Boot option.		
Network Stack	Enabled	Optimal Default, Failsafe Default
	Disabled	
Enable/Disable UEFI Network Stack.		
FIXED BOOT ORDER Priorities	Sets the system boot order.	

3.8 Setup Submenu: Save & Exit

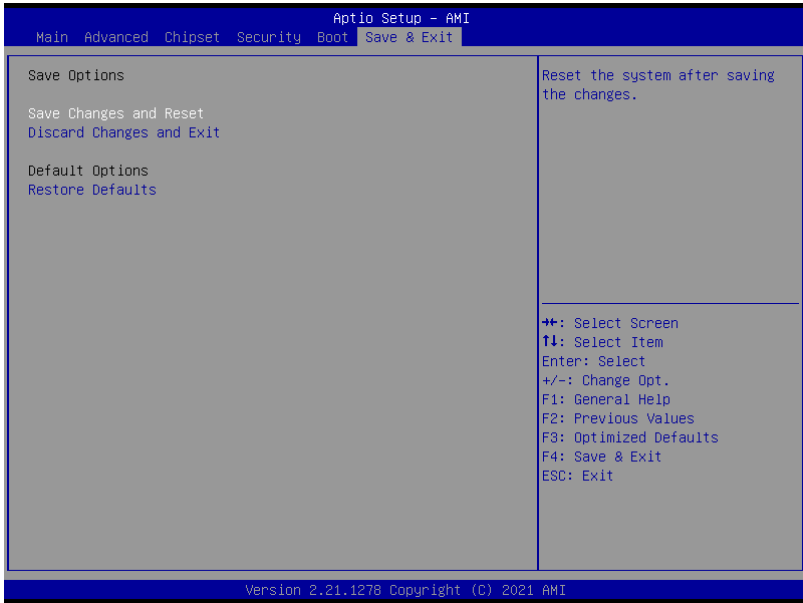

Chapter 4

Drivers Installation

4.1 Drivers Download and Installation

Drivers for the BOXER-6643-TGU can be downloaded from the product page on the AAEON website by following this link:

<https://www.aaeon.com/en/p/fanless-embedded-box-pc-socket-type-boxer-6643-tgu>

Download the driver(s) you need and follow the steps below to install them.

Step 1 – Install Chipset Driver

1. Open the **Step 1 - Chipset** folder
2. Run the **SetupChipset.exe** file in the folder
3. Follow the instructions
4. Drivers will be installed automatically

Step 2 – Install Graphics Driver

1. Open the **Step 2 - Graphic** folder
2. Run the **igxpin.exe** file in the folder
3. Follow the instructions
4. Drivers will be installed automatically

Step 3 – Install ME Driver

1. Open the **Step 3 - ME** folder
2. Run the **SetupME.exe** file in the folder
3. Follow the instructions
4. Drivers will be installed automatically

Step 4 – LAN

1. Open the **Step 4 - LAN** folder
2. Run the **PROWinx64.exe** file in the folder
3. Follow the instructions
4. Drivers will be installed automatically

Step 5 – Install Audio Driver

1. Open the **Step 5 – Audio** folder
2. Run the **Setup.exe** file in the folder
3. Follow the instructions
4. Drivers will be installed automatically

Step 6 – Install Serial Port Patch (Optional)

1. Open the **Step 6 – Serial Port Driver (Optional)** folder
2. Run the **FintekSerial.exe** file in the folder
3. Follow the instructions
4. Drivers will be installed automatically

































Appendix A

I/O Information



















































A.1 I/O Address Map













































Input/output (IO)	
[0000000000000000 - 000000000000001F]	Direct memory access controller
[0000000000000000 - 000000000000CF7]	PCI Express Root Complex
[0000000000000010 - 000000000000001F]	Motherboard resources
[0000000000000020 - 0000000000000021]	Programmable interrupt controller
[0000000000000020 - 0000000000000021]	Programmable interrupt controller
[0000000000000022 - 000000000000003F]	Motherboard resources
[0000000000000024 - 0000000000000025]	Programmable interrupt controller
[0000000000000024 - 0000000000000025]	Programmable interrupt controller
[0000000000000024 - 0000000000000025]	Programmable interrupt controller
[0000000000000028 - 0000000000000029]	Programmable interrupt controller
[0000000000000028 - 0000000000000029]	Programmable interrupt controller
[0000000000000028 - 0000000000000029]	Programmable interrupt controller
[000000000000002C - 000000000000002D]	Programmable interrupt controller
[000000000000002C - 000000000000002D]	Programmable interrupt controller
[000000000000002C - 000000000000002D]	Programmable interrupt controller
[000000000000002E - 000000000000002F]	Motherboard resources
[0000000000000030 - 0000000000000031]	Programmable interrupt controller
[0000000000000030 - 0000000000000031]	Programmable interrupt controller
[0000000000000030 - 0000000000000031]	Programmable interrupt controller
[0000000000000034 - 0000000000000035]	Programmable interrupt controller
[0000000000000034 - 0000000000000035]	Programmable interrupt controller
[0000000000000034 - 0000000000000035]	Programmable interrupt controller
[0000000000000038 - 0000000000000039]	Programmable interrupt controller
[0000000000000038 - 0000000000000039]	Programmable interrupt controller
[0000000000000038 - 0000000000000039]	Programmable interrupt controller
[000000000000003C - 000000000000003D]	Programmable interrupt controller
[000000000000003C - 000000000000003D]	Programmable interrupt controller
[000000000000003C - 000000000000003D]	Programmable interrupt controller
[0000000000000040 - 0000000000000043]	System timer
[0000000000000040 - 0000000000000043]	System timer
[0000000000000040 - 0000000000000043]	System timer
[0000000000000044 - 000000000000005F]	Motherboard resources
[000000000000004E - 000000000000004F]	Motherboard resources
[0000000000000050 - 0000000000000053]	System timer
[0000000000000050 - 0000000000000053]	System timer
[0000000000000050 - 0000000000000053]	System timer
[0000000000000060 - 0000000000000060]	Microsoft PS/2 Mouse
[0000000000000061 - 0000000000000061]	Motherboard resources
[0000000000000062 - 0000000000000063]	Motherboard resources
[0000000000000063 - 0000000000000063]	Motherboard resources
[0000000000000064 - 0000000000000064]	Microsoft PS/2 Mouse
[0000000000000065 - 0000000000000065]	Motherboard resources
[0000000000000065 - 000000000000006F]	Motherboard resources
[0000000000000067 - 0000000000000067]	Motherboard resources
[0000000000000070 - 0000000000000070]	Motherboard resources
[0000000000000070 - 0000000000000077]	System CMOS/real time clock
[0000000000000072 - 000000000000007F]	Motherboard resources
[0000000000000080 - 0000000000000080]	Motherboard resources
[0000000000000080 - 0000000000000080]	Motherboard resources



















































[000000000000081 - 000000000000091]	Direct memory access controller
[000000000000084 - 000000000000086]	Motherboard resources
[000000000000088 - 000000000000088]	Motherboard resources
[00000000000008C - 00000000000008E]	Motherboard resources
[000000000000090 - 00000000000009F]	Motherboard resources
[000000000000092 - 000000000000092]	Motherboard resources
[000000000000093 - 00000000000009F]	Direct memory access controller
[0000000000000A0 - 0000000000000A1]	Programmable interrupt controller
[0000000000000A0 - 0000000000000A1]	Programmable interrupt controller
[0000000000000A0 - 0000000000000A1]	Programmable interrupt controller
[0000000000000A2 - 0000000000000BF]	Motherboard resources
[0000000000000A4 - 0000000000000A5]	Programmable interrupt controller
[0000000000000A4 - 0000000000000A5]	Programmable interrupt controller
[0000000000000A4 - 0000000000000A5]	Programmable interrupt controller
[0000000000000A8 - 0000000000000A9]	Programmable interrupt controller
[0000000000000A8 - 0000000000000A9]	Programmable interrupt controller
[0000000000000A8 - 0000000000000A9]	Programmable interrupt controller
[0000000000000A8 - 0000000000000A9]	Programmable interrupt controller
[0000000000000AC - 0000000000000AD]	Programmable interrupt controller
[0000000000000AC - 0000000000000AD]	Programmable interrupt controller
[0000000000000AC - 0000000000000AD]	Programmable interrupt controller
[0000000000000B0 - 0000000000000B1]	Programmable interrupt controller
[0000000000000B0 - 0000000000000B1]	Programmable interrupt controller
[0000000000000B0 - 0000000000000B1]	Programmable interrupt controller
[0000000000000B2 - 0000000000000B3]	Motherboard resources
[0000000000000B4 - 0000000000000B5]	Programmable interrupt controller
[0000000000000B4 - 0000000000000B5]	Programmable interrupt controller
[0000000000000B4 - 0000000000000B5]	Programmable interrupt controller
[0000000000000B8 - 0000000000000B9]	Programmable interrupt controller
[0000000000000B8 - 0000000000000B9]	Programmable interrupt controller
[0000000000000B8 - 0000000000000B9]	Programmable interrupt controller
[0000000000000BC - 0000000000000BD]	Programmable interrupt controller
[0000000000000BC - 0000000000000BD]	Programmable interrupt controller
[0000000000000BC - 0000000000000BD]	Programmable interrupt controller
[0000000000000C0 - 0000000000000DF]	Direct memory access controller
[0000000000000E0 - 0000000000000EF]	Motherboard resources
[0000000000000F0 - 0000000000000F0]	Numeric data processor
[00000000000002C0 - 00000000000002C7]	Communications Port (COM3)
[00000000000002C8 - 00000000000002CF]	Communications Port (COM4)
[00000000000002E8 - 00000000000002EF]	Communications Port (COM4)
[00000000000002F8 - 00000000000002FF]	Communications Port (COM2)
[0000000000000378 - 000000000000037F]	Printer Port (LPT1)
[00000000000003E8 - 00000000000003EF]	Communications Port (COM3)
[00000000000003F8 - 00000000000003FF]	Communications Port (COM1)
[00000000000004D0 - 00000000000004D1]	Motherboard resources
[00000000000004D0 - 00000000000004D1]	Programmable interrupt controller
[00000000000004D0 - 00000000000004D1]	Programmable interrupt controller
[00000000000004D0 - 00000000000004D1]	Programmable interrupt controller
[0000000000000680 - 000000000000069F]	Motherboard resources
[0000000000000A00 - 0000000000000A0F]	Motherboard resources
[0000000000000A00 - 0000000000000A0F]	Motherboard resources
[0000000000000A10 - 0000000000000A1F]	Motherboard resources















































	[000000000000A10 - 000000000000A1F]	Motherboard resources
	[000000000000A20 - 000000000000A2F]	Motherboard resources
	[000000000000A20 - 000000000000A2F]	Motherboard resources
	[000000000000D00 - 000000000000FFFF]	PCI Express Root Complex
	[000000000000164E - 000000000000164F]	Motherboard resources
	[0000000000001800 - 00000000000018FE]	Motherboard resources
	[0000000000001854 - 0000000000001857]	Motherboard resources
	[0000000000001854 - 0000000000001857]	Motherboard resources
	[0000000000001854 - 0000000000001857]	Motherboard resources
	[0000000000002000 - 00000000000020FE]	Motherboard resources
	[0000000000003000 - 000000000000303F]	Intel(R) Iris(R) Xe Graphics
	[0000000000003000 - 000000000000303F]	Microsoft Basic Display Adapter
	[0000000000003060 - 000000000000307F]	Standard SATA AHCI Controller
	[0000000000003060 - 000000000000307F]	Standard SATA AHCI Controller
	[0000000000003080 - 0000000000003083]	Standard SATA AHCI Controller
	[0000000000003080 - 0000000000003083]	Standard SATA AHCI Controller
	[0000000000003090 - 0000000000003097]	Standard SATA AHCI Controller
	[0000000000003090 - 0000000000003097]	Standard SATA AHCI Controller
	[000000000000D000 - 000000000000D0FF]	Realtek PCIe GBE Family Controller #2
	[000000000000D000 - 000000000000DFFF]	PCI Express Root Port
	[000000000000E000 - 000000000000E0FF]	Realtek PCIe GBE Family Controller
	[000000000000E000 - 000000000000EFFF]	PCI Express Root Port
	[000000000000EFA0 - 000000000000EFBF]	Intel(R) SMBus - 9DA3
	[000000000000EFA0 - 000000000000EFBF]	Intel(R) SMBus - A0A3
	[000000000000F000 - 000000000000F03F]	Microsoft Basic Display Adapter
	[000000000000F040 - 000000000000F05F]	SM Bus Controller
	[000000000000F060 - 000000000000F07F]	Standard SATA AHCI Controller
	[000000000000F080 - 000000000000F083]	Standard SATA AHCI Controller
	[000000000000F090 - 000000000000F097]	Standard SATA AHCI Controller
	[000000000000F0A0 - 000000000000F0A3]	Standard SATA AHCI Controller
	[000000000000F0B0 - 000000000000F0B7]	Standard SATA AHCI Controller
	[000000000000FFF8 - 000000000000FFFF]	Intel(R) Active Management Technology - SOL (COM5)















































A.2 IRQ Mapping Chart



















































▼	Interrupt request (IRQ)
	(ISA) 0x00000000 (00) System timer
	(ISA) 0x00000000 (00) System timer
	(ISA) 0x00000000 (00) System timer
	(ISA) 0x00000003 (03) Communications Port (COM2)
	(ISA) 0x00000004 (04) Communications Port (COM1)
	(ISA) 0x00000005 (05) Communications Port (COM4)
	(ISA) 0x00000007 (07) Printer Port (LPT1)
	(ISA) 0x00000008 (08) System CMOS/real time clock
	(ISA) 0x0000000A (10) Intel(R) 8 Series/C220 Series USB EHCI #1 - 8C26
	(ISA) 0x0000000A (10) Intel(R) 8 Series/C220 Series USB EHCI #2 - 8C2D
	(ISA) 0x0000000A (10) Intel(R) USB 3.0 eXtensible Host Controller - 1.0 (Microsoft)
	(ISA) 0x0000000A (10) Microsoft Basic Display Adapter
	(ISA) 0x0000000A (10) PCI Express Root Port
	(ISA) 0x0000000A (10) PCI Express Root Port
	(ISA) 0x0000000A (10) PCI Express Root Port
	(ISA) 0x0000000A (10) PCI Express Root Port
	(ISA) 0x0000000A (10) PCI Express Root Port
	(ISA) 0x0000000A (10) PCI Express Root Port
	(ISA) 0x0000000A (10) PCI Express to PCI/PCI-X Bridge
	(ISA) 0x0000000A (10) PCI Simple Communications Controller
	(ISA) 0x0000000A (10) Realtek PCIe GBE Family Controller
	(ISA) 0x0000000A (10) Realtek PCIe GBE Family Controller #2
	(ISA) 0x0000000A (10) SM Bus Controller
	(ISA) 0x0000000B (11) Communications Port (COM3)
	(ISA) 0x0000000B (11) Communications Port (COM3)
	(ISA) 0x0000000B (11) Communications Port (COM4)
	(ISA) 0x0000000C (12) Microsoft PS/2 Mouse
	(ISA) 0x0000000D (13) Numeric data processor
	(ISA) 0x0000000E (14) Intel(R) GPIO Controller - 34C5
	(ISA) 0x0000000E (14) Intel(R) Serial IO GPIO Host Controller - INT34BB
	(ISA) 0x0000000F (15) Standard SATA AHCI Controller
	(ISA) 0x0000001C (28) Trusted Platform Module 2.0
	(ISA) 0x00000036 (54) Microsoft ACPI-Compliant System
	(ISA) 0x00000037 (55) Microsoft ACPI-Compliant System
	(ISA) 0x00000038 (56) Microsoft ACPI-Compliant System
	(ISA) 0x00000039 (57) Microsoft ACPI-Compliant System
	(ISA) 0x0000003A (58) Microsoft ACPI-Compliant System
	(ISA) 0x0000003B (59) Microsoft ACPI-Compliant System
	(ISA) 0x0000003C (60) Microsoft ACPI-Compliant System
	(ISA) 0x0000003D (61) Microsoft ACPI-Compliant System
	(ISA) 0x0000003E (62) Microsoft ACPI-Compliant System
	(ISA) 0x0000003F (63) Microsoft ACPI-Compliant System
	(ISA) 0x00000040 (64) Microsoft ACPI-Compliant System
	(ISA) 0x00000041 (65) Microsoft ACPI-Compliant System
	(ISA) 0x00000042 (66) Microsoft ACPI-Compliant System
	(ISA) 0x00000043 (67) Microsoft ACPI-Compliant System
	(ISA) 0x00000044 (68) Microsoft ACPI-Compliant System
	(ISA) 0x00000045 (69) Microsoft ACPI-Compliant System
	(ISA) 0x00000046 (70) Microsoft ACPI-Compliant System
	(ISA) 0x00000047 (71) Microsoft ACPI-Compliant System
	(ISA) 0x00000048 (72) Microsoft ACPI-Compliant System















































 (ISA) 0x00000049 (73)	Microsoft ACPI-Compliant System
 (ISA) 0x0000004A (74)	Microsoft ACPI-Compliant System
 (ISA) 0x0000004B (75)	Microsoft ACPI-Compliant System
 (ISA) 0x0000004C (76)	Microsoft ACPI-Compliant System
 (ISA) 0x0000004D (77)	Microsoft ACPI-Compliant System
 (ISA) 0x0000004E (78)	Microsoft ACPI-Compliant System
 (ISA) 0x0000004F (79)	Microsoft ACPI-Compliant System
 (ISA) 0x00000050 (80)	Microsoft ACPI-Compliant System
 (ISA) 0x00000051 (81)	Microsoft ACPI-Compliant System
 (ISA) 0x00000052 (82)	Microsoft ACPI-Compliant System
 (ISA) 0x00000053 (83)	Microsoft ACPI-Compliant System
 (ISA) 0x00000054 (84)	Microsoft ACPI-Compliant System
 (ISA) 0x00000055 (85)	Microsoft ACPI-Compliant System
 (ISA) 0x00000056 (86)	Microsoft ACPI-Compliant System
 (ISA) 0x00000057 (87)	Microsoft ACPI-Compliant System
 (ISA) 0x00000058 (88)	Microsoft ACPI-Compliant System
 (ISA) 0x00000059 (89)	Microsoft ACPI-Compliant System
 (ISA) 0x0000005A (90)	Microsoft ACPI-Compliant System
 (ISA) 0x0000005B (91)	Microsoft ACPI-Compliant System
 (ISA) 0x0000005C (92)	Microsoft ACPI-Compliant System
 (ISA) 0x0000005D (93)	Microsoft ACPI-Compliant System
 (ISA) 0x0000005E (94)	Microsoft ACPI-Compliant System
 (ISA) 0x0000005F (95)	Microsoft ACPI-Compliant System
 (ISA) 0x00000060 (96)	Microsoft ACPI-Compliant System
 (ISA) 0x00000061 (97)	Microsoft ACPI-Compliant System
 (ISA) 0x00000062 (98)	Microsoft ACPI-Compliant System
 (ISA) 0x00000063 (99)	Microsoft ACPI-Compliant System
 (ISA) 0x00000064 (100)	Microsoft ACPI-Compliant System
 (ISA) 0x00000065 (101)	Microsoft ACPI-Compliant System
 (ISA) 0x00000066 (102)	Microsoft ACPI-Compliant System
 (ISA) 0x00000067 (103)	Microsoft ACPI-Compliant System
 (ISA) 0x00000068 (104)	Microsoft ACPI-Compliant System
 (ISA) 0x00000069 (105)	Microsoft ACPI-Compliant System
 (ISA) 0x0000006A (106)	Microsoft ACPI-Compliant System
 (ISA) 0x0000006B (107)	Microsoft ACPI-Compliant System
 (ISA) 0x0000006C (108)	Microsoft ACPI-Compliant System
 (ISA) 0x0000006D (109)	Microsoft ACPI-Compliant System
 (ISA) 0x0000006E (110)	Microsoft ACPI-Compliant System
 (ISA) 0x0000006F (111)	Microsoft ACPI-Compliant System
 (ISA) 0x00000070 (112)	Microsoft ACPI-Compliant System
 (ISA) 0x00000071 (113)	Microsoft ACPI-Compliant System
 (ISA) 0x00000072 (114)	Microsoft ACPI-Compliant System
 (ISA) 0x00000073 (115)	Microsoft ACPI-Compliant System
 (ISA) 0x00000074 (116)	Microsoft ACPI-Compliant System
 (ISA) 0x00000075 (117)	Microsoft ACPI-Compliant System
(ISA) 0x00000076 (118)	Microsoft ACPI-Compliant System
(ISA) 0x00000077 (119)	Microsoft ACPI-Compliant System
(ISA) 0x00000078 (120)	Microsoft ACPI-Compliant System
(ISA) 0x00000079 (121)	Microsoft ACPI-Compliant System
(ISA) 0x0000007A (122)	Microsoft ACPI-Compliant System



















































 (ISA) 0x000007B (123)	Microsoft ACPI-Compliant System
 (ISA) 0x000007C (124)	Microsoft ACPI-Compliant System
 (ISA) 0x000007D (125)	Microsoft ACPI-Compliant System
 (ISA) 0x000007E (126)	Microsoft ACPI-Compliant System
 (ISA) 0x000007F (127)	Microsoft ACPI-Compliant System
 (ISA) 0x0000080 (128)	Microsoft ACPI-Compliant System
 (ISA) 0x0000081 (129)	Microsoft ACPI-Compliant System
 (ISA) 0x0000082 (130)	Microsoft ACPI-Compliant System
 (ISA) 0x0000083 (131)	Microsoft ACPI-Compliant System
 (ISA) 0x0000084 (132)	Microsoft ACPI-Compliant System
 (ISA) 0x0000085 (133)	Microsoft ACPI-Compliant System
 (ISA) 0x0000086 (134)	Microsoft ACPI-Compliant System
 (ISA) 0x0000087 (135)	Microsoft ACPI-Compliant System
 (ISA) 0x0000088 (136)	Microsoft ACPI-Compliant System
 (ISA) 0x0000089 (137)	Microsoft ACPI-Compliant System
 (ISA) 0x000008A (138)	Microsoft ACPI-Compliant System
 (ISA) 0x000008B (139)	Microsoft ACPI-Compliant System
 (ISA) 0x000008C (140)	Microsoft ACPI-Compliant System
 (ISA) 0x000008D (141)	Microsoft ACPI-Compliant System
 (ISA) 0x000008E (142)	Microsoft ACPI-Compliant System
 (ISA) 0x000008F (143)	Microsoft ACPI-Compliant System
 (ISA) 0x0000090 (144)	Microsoft ACPI-Compliant System
 (ISA) 0x0000091 (145)	Microsoft ACPI-Compliant System
 (ISA) 0x0000092 (146)	Microsoft ACPI-Compliant System
 (ISA) 0x0000093 (147)	Microsoft ACPI-Compliant System
 (ISA) 0x0000094 (148)	Microsoft ACPI-Compliant System
 (ISA) 0x0000095 (149)	Microsoft ACPI-Compliant System
 (ISA) 0x0000096 (150)	Microsoft ACPI-Compliant System
 (ISA) 0x0000097 (151)	Microsoft ACPI-Compliant System
 (ISA) 0x0000098 (152)	Microsoft ACPI-Compliant System
 (ISA) 0x0000099 (153)	Microsoft ACPI-Compliant System
 (ISA) 0x000009A (154)	Microsoft ACPI-Compliant System
 (ISA) 0x000009B (155)	Microsoft ACPI-Compliant System
 (ISA) 0x000009C (156)	Microsoft ACPI-Compliant System
 (ISA) 0x000009D (157)	Microsoft ACPI-Compliant System
 (ISA) 0x000009E (158)	Microsoft ACPI-Compliant System
 (ISA) 0x000009F (159)	Microsoft ACPI-Compliant System
 (ISA) 0x00000A0 (160)	Microsoft ACPI-Compliant System
 (ISA) 0x00000A1 (161)	Microsoft ACPI-Compliant System
 (ISA) 0x00000A2 (162)	Microsoft ACPI-Compliant System
 (ISA) 0x00000A3 (163)	Microsoft ACPI-Compliant System
 (ISA) 0x00000A4 (164)	Microsoft ACPI-Compliant System
 (ISA) 0x00000A5 (165)	Microsoft ACPI-Compliant System
 (ISA) 0x00000A6 (166)	Microsoft ACPI-Compliant System
 (ISA) 0x00000A7 (167)	Microsoft ACPI-Compliant System
 (ISA) 0x00000A8 (168)	Microsoft ACPI-Compliant System
 (ISA) 0x00000A9 (169)	Microsoft ACPI-Compliant System
 (ISA) 0x00000AA (170)	Microsoft ACPI-Compliant System
 (ISA) 0x00000AB (171)	Microsoft ACPI-Compliant System
 (ISA) 0x00000AC (172)	Microsoft ACPI-Compliant System













































 (ISA) 0x000000AD (173)	Microsoft ACPI-Compliant System
 (ISA) 0x000000AE (174)	Microsoft ACPI-Compliant System
 (ISA) 0x000000AF (175)	Microsoft ACPI-Compliant System
 (ISA) 0x000000B0 (176)	Microsoft ACPI-Compliant System
 (ISA) 0x000000B1 (177)	Microsoft ACPI-Compliant System
 (ISA) 0x000000B2 (178)	Microsoft ACPI-Compliant System
 (ISA) 0x000000B3 (179)	Microsoft ACPI-Compliant System
 (ISA) 0x000000B4 (180)	Microsoft ACPI-Compliant System
 (ISA) 0x000000B5 (181)	Microsoft ACPI-Compliant System
 (ISA) 0x000000B6 (182)	Microsoft ACPI-Compliant System
 (ISA) 0x000000B7 (183)	Microsoft ACPI-Compliant System
 (ISA) 0x000000B8 (184)	Microsoft ACPI-Compliant System
 (ISA) 0x000000B9 (185)	Microsoft ACPI-Compliant System
 (ISA) 0x000000BA (186)	Microsoft ACPI-Compliant System
 (ISA) 0x000000BB (187)	Microsoft ACPI-Compliant System
 (ISA) 0x000000BC (188)	Microsoft ACPI-Compliant System
 (ISA) 0x000000BD (189)	Microsoft ACPI-Compliant System
 (ISA) 0x000000BE (190)	Microsoft ACPI-Compliant System
 (ISA) 0x000000BF (191)	Microsoft ACPI-Compliant System
 (ISA) 0x000000C0 (192)	Microsoft ACPI-Compliant System
 (ISA) 0x000000C1 (193)	Microsoft ACPI-Compliant System
 (ISA) 0x000000C2 (194)	Microsoft ACPI-Compliant System
 (ISA) 0x000000C3 (195)	Microsoft ACPI-Compliant System
 (ISA) 0x000000C4 (196)	Microsoft ACPI-Compliant System
 (ISA) 0x000000C5 (197)	Microsoft ACPI-Compliant System
 (ISA) 0x000000C6 (198)	Microsoft ACPI-Compliant System
 (ISA) 0x000000C7 (199)	Microsoft ACPI-Compliant System
 (ISA) 0x000000C8 (200)	Microsoft ACPI-Compliant System
 (ISA) 0x000000C9 (201)	Microsoft ACPI-Compliant System
 (ISA) 0x000000CA (202)	Microsoft ACPI-Compliant System
 (ISA) 0x000000CB (203)	Microsoft ACPI-Compliant System
 (ISA) 0x000000CC (204)	Microsoft ACPI-Compliant System
 (ISA) 0x00000100 (256)	Microsoft ACPI-Compliant System
 (ISA) 0x00000101 (257)	Microsoft ACPI-Compliant System
 (ISA) 0x00000102 (258)	Microsoft ACPI-Compliant System
 (ISA) 0x00000103 (259)	Microsoft ACPI-Compliant System
 (ISA) 0x00000104 (260)	Microsoft ACPI-Compliant System
 (ISA) 0x00000105 (261)	Microsoft ACPI-Compliant System
 (ISA) 0x00000106 (262)	Microsoft ACPI-Compliant System
 (ISA) 0x00000107 (263)	Microsoft ACPI-Compliant System
 (ISA) 0x00000108 (264)	Microsoft ACPI-Compliant System
 (ISA) 0x00000109 (265)	Microsoft ACPI-Compliant System
 (ISA) 0x0000010A (266)	Microsoft ACPI-Compliant System
 (ISA) 0x0000010B (267)	Microsoft ACPI-Compliant System
 (ISA) 0x0000010C (268)	Microsoft ACPI-Compliant System
 (ISA) 0x0000010D (269)	Microsoft ACPI-Compliant System
 (ISA) 0x0000010E (270)	Microsoft ACPI-Compliant System
(ISA) 0x0000010F (271)	Microsoft ACPI-Compliant System
(ISA) 0x00000110 (272)	Microsoft ACPI-Compliant System
(ISA) 0x00000111 (273)	Microsoft ACPI-Compliant System
(ISA) 0x00000112 (274)	Microsoft ACPI-Compliant System

 (ISA) 0x00000113 (275)	Microsoft ACPI-Compliant System
 (ISA) 0x00000114 (276)	Microsoft ACPI-Compliant System
 (ISA) 0x00000115 (277)	Microsoft ACPI-Compliant System
 (ISA) 0x00000116 (278)	Microsoft ACPI-Compliant System
 (ISA) 0x00000117 (279)	Microsoft ACPI-Compliant System
 (ISA) 0x00000118 (280)	Microsoft ACPI-Compliant System
 (ISA) 0x00000119 (281)	Microsoft ACPI-Compliant System
 (ISA) 0x0000011A (282)	Microsoft ACPI-Compliant System
 (ISA) 0x0000011B (283)	Microsoft ACPI-Compliant System
 (ISA) 0x0000011C (284)	Microsoft ACPI-Compliant System
 (ISA) 0x0000011D (285)	Microsoft ACPI-Compliant System
 (ISA) 0x0000011E (286)	Microsoft ACPI-Compliant System
 (ISA) 0x0000011F (287)	Microsoft ACPI-Compliant System
 (ISA) 0x00000120 (288)	Microsoft ACPI-Compliant System
 (ISA) 0x00000121 (289)	Microsoft ACPI-Compliant System
 (ISA) 0x00000122 (290)	Microsoft ACPI-Compliant System
 (ISA) 0x00000123 (291)	Microsoft ACPI-Compliant System
 (ISA) 0x00000124 (292)	Microsoft ACPI-Compliant System
 (ISA) 0x00000125 (293)	Microsoft ACPI-Compliant System
 (ISA) 0x00000126 (294)	Microsoft ACPI-Compliant System
 (ISA) 0x00000127 (295)	Microsoft ACPI-Compliant System
 (ISA) 0x00000128 (296)	Microsoft ACPI-Compliant System
 (ISA) 0x00000129 (297)	Microsoft ACPI-Compliant System
 (ISA) 0x0000012A (298)	Microsoft ACPI-Compliant System
 (ISA) 0x0000012B (299)	Microsoft ACPI-Compliant System
 (ISA) 0x0000012C (300)	Microsoft ACPI-Compliant System
 (ISA) 0x0000012D (301)	Microsoft ACPI-Compliant System
 (ISA) 0x0000012E (302)	Microsoft ACPI-Compliant System
 (ISA) 0x0000012F (303)	Microsoft ACPI-Compliant System
 (ISA) 0x00000130 (304)	Microsoft ACPI-Compliant System
 (ISA) 0x00000131 (305)	Microsoft ACPI-Compliant System
 (ISA) 0x00000132 (306)	Microsoft ACPI-Compliant System
 (ISA) 0x00000133 (307)	Microsoft ACPI-Compliant System
 (ISA) 0x00000134 (308)	Microsoft ACPI-Compliant System
 (ISA) 0x00000135 (309)	Microsoft ACPI-Compliant System
 (ISA) 0x00000136 (310)	Microsoft ACPI-Compliant System
 (ISA) 0x00000137 (311)	Microsoft ACPI-Compliant System
 (ISA) 0x00000138 (312)	Microsoft ACPI-Compliant System
 (ISA) 0x00000139 (313)	Microsoft ACPI-Compliant System
 (ISA) 0x0000013A (314)	Microsoft ACPI-Compliant System
 (ISA) 0x0000013B (315)	Microsoft ACPI-Compliant System
 (ISA) 0x0000013C (316)	Microsoft ACPI-Compliant System
 (ISA) 0x0000013D (317)	Microsoft ACPI-Compliant System
 (ISA) 0x0000013E (318)	Microsoft ACPI-Compliant System
 (ISA) 0x0000013F (319)	Microsoft ACPI-Compliant System
 (ISA) 0x00000140 (320)	Microsoft ACPI-Compliant System
 (ISA) 0x00000141 (321)	Microsoft ACPI-Compliant System
(ISA) 0x00000142 (322)	Microsoft ACPI-Compliant System
(ISA) 0x00000143 (323)	Microsoft ACPI-Compliant System
(ISA) 0x00000144 (324)	Microsoft ACPI-Compliant System
(ISA) 0x00000145 (325)	Microsoft ACPI-Compliant System

 (ISA) 0x00000146 (326)	Microsoft ACPI-Compliant System
 (ISA) 0x00000147 (327)	Microsoft ACPI-Compliant System
 (ISA) 0x00000148 (328)	Microsoft ACPI-Compliant System
 (ISA) 0x00000149 (329)	Microsoft ACPI-Compliant System
 (ISA) 0x0000014A (330)	Microsoft ACPI-Compliant System
 (ISA) 0x0000014B (331)	Microsoft ACPI-Compliant System
 (ISA) 0x0000014C (332)	Microsoft ACPI-Compliant System
 (ISA) 0x0000014D (333)	Microsoft ACPI-Compliant System
 (ISA) 0x0000014E (334)	Microsoft ACPI-Compliant System
 (ISA) 0x0000014F (335)	Microsoft ACPI-Compliant System
 (ISA) 0x00000150 (336)	Microsoft ACPI-Compliant System
 (ISA) 0x00000151 (337)	Microsoft ACPI-Compliant System
 (ISA) 0x00000152 (338)	Microsoft ACPI-Compliant System
 (ISA) 0x00000153 (339)	Microsoft ACPI-Compliant System
 (ISA) 0x00000154 (340)	Microsoft ACPI-Compliant System
 (ISA) 0x00000155 (341)	Microsoft ACPI-Compliant System
 (ISA) 0x00000156 (342)	Microsoft ACPI-Compliant System
 (ISA) 0x00000157 (343)	Microsoft ACPI-Compliant System
 (ISA) 0x00000158 (344)	Microsoft ACPI-Compliant System
 (ISA) 0x00000159 (345)	Microsoft ACPI-Compliant System
 (ISA) 0x0000015A (346)	Microsoft ACPI-Compliant System
 (ISA) 0x0000015B (347)	Microsoft ACPI-Compliant System
 (ISA) 0x0000015C (348)	Microsoft ACPI-Compliant System
 (ISA) 0x0000015D (349)	Microsoft ACPI-Compliant System
 (ISA) 0x0000015E (350)	Microsoft ACPI-Compliant System
 (ISA) 0x0000015F (351)	Microsoft ACPI-Compliant System
 (ISA) 0x00000160 (352)	Microsoft ACPI-Compliant System
 (ISA) 0x00000161 (353)	Microsoft ACPI-Compliant System
 (ISA) 0x00000162 (354)	Microsoft ACPI-Compliant System
 (ISA) 0x00000163 (355)	Microsoft ACPI-Compliant System
 (ISA) 0x00000164 (356)	Microsoft ACPI-Compliant System
 (ISA) 0x00000165 (357)	Microsoft ACPI-Compliant System
 (ISA) 0x00000166 (358)	Microsoft ACPI-Compliant System
 (ISA) 0x00000167 (359)	Microsoft ACPI-Compliant System
 (ISA) 0x00000168 (360)	Microsoft ACPI-Compliant System
 (ISA) 0x00000169 (361)	Microsoft ACPI-Compliant System
 (ISA) 0x0000016A (362)	Microsoft ACPI-Compliant System
 (ISA) 0x0000016B (363)	Microsoft ACPI-Compliant System
 (ISA) 0x0000016C (364)	Microsoft ACPI-Compliant System
 (ISA) 0x0000016D (365)	Microsoft ACPI-Compliant System
 (ISA) 0x0000016E (366)	Microsoft ACPI-Compliant System
 (ISA) 0x0000016F (367)	Microsoft ACPI-Compliant System
 (ISA) 0x00000170 (368)	Microsoft ACPI-Compliant System
 (ISA) 0x00000171 (369)	Microsoft ACPI-Compliant System
 (ISA) 0x00000172 (370)	Microsoft ACPI-Compliant System
 (ISA) 0x00000173 (371)	Microsoft ACPI-Compliant System
 (ISA) 0x00000174 (372)	Microsoft ACPI-Compliant System
 (ISA) 0x00000175 (373)	Microsoft ACPI-Compliant System
 (ISA) 0x00000176 (374)	Microsoft ACPI-Compliant System
 (ISA) 0x00000177 (375)	Microsoft ACPI-Compliant System
 (ISA) 0x00000178 (376)	Microsoft ACPI-Compliant System

































 (ISA) 0x0000179 (377)	Microsoft ACPI-Compliant System
 (ISA) 0x000017A (378)	Microsoft ACPI-Compliant System
 (ISA) 0x000017B (379)	Microsoft ACPI-Compliant System
 (ISA) 0x000017C (380)	Microsoft ACPI-Compliant System
 (ISA) 0x000017D (381)	Microsoft ACPI-Compliant System
 (ISA) 0x000017E (382)	Microsoft ACPI-Compliant System
 (ISA) 0x000017F (383)	Microsoft ACPI-Compliant System
 (ISA) 0x0000180 (384)	Microsoft ACPI-Compliant System
 (ISA) 0x0000181 (385)	Microsoft ACPI-Compliant System
 (ISA) 0x0000182 (386)	Microsoft ACPI-Compliant System
 (ISA) 0x0000183 (387)	Microsoft ACPI-Compliant System
 (ISA) 0x0000184 (388)	Microsoft ACPI-Compliant System
 (ISA) 0x0000185 (389)	Microsoft ACPI-Compliant System
 (ISA) 0x0000186 (390)	Microsoft ACPI-Compliant System
 (ISA) 0x0000187 (391)	Microsoft ACPI-Compliant System
 (ISA) 0x0000188 (392)	Microsoft ACPI-Compliant System
 (ISA) 0x0000189 (393)	Microsoft ACPI-Compliant System
 (ISA) 0x000018A (394)	Microsoft ACPI-Compliant System
 (ISA) 0x000018B (395)	Microsoft ACPI-Compliant System
 (ISA) 0x000018C (396)	Microsoft ACPI-Compliant System
 (ISA) 0x000018D (397)	Microsoft ACPI-Compliant System
 (ISA) 0x000018E (398)	Microsoft ACPI-Compliant System
 (ISA) 0x000018F (399)	Microsoft ACPI-Compliant System
 (ISA) 0x0000190 (400)	Microsoft ACPI-Compliant System
 (ISA) 0x0000191 (401)	Microsoft ACPI-Compliant System
 (ISA) 0x0000192 (402)	Microsoft ACPI-Compliant System
 (ISA) 0x0000193 (403)	Microsoft ACPI-Compliant System
 (ISA) 0x0000194 (404)	Microsoft ACPI-Compliant System
 (ISA) 0x0000195 (405)	Microsoft ACPI-Compliant System
 (ISA) 0x0000196 (406)	Microsoft ACPI-Compliant System
 (ISA) 0x0000197 (407)	Microsoft ACPI-Compliant System
 (ISA) 0x0000198 (408)	Microsoft ACPI-Compliant System
 (ISA) 0x0000199 (409)	Microsoft ACPI-Compliant System
 (ISA) 0x000019A (410)	Microsoft ACPI-Compliant System
 (ISA) 0x000019B (411)	Microsoft ACPI-Compliant System
 (ISA) 0x000019C (412)	Microsoft ACPI-Compliant System
 (ISA) 0x000019D (413)	Microsoft ACPI-Compliant System
 (ISA) 0x000019E (414)	Microsoft ACPI-Compliant System
 (ISA) 0x000019F (415)	Microsoft ACPI-Compliant System
 (ISA) 0x00001A0 (416)	Microsoft ACPI-Compliant System
 (ISA) 0x00001A1 (417)	Microsoft ACPI-Compliant System
 (ISA) 0x00001A2 (418)	Microsoft ACPI-Compliant System
 (ISA) 0x00001A3 (419)	Microsoft ACPI-Compliant System
 (ISA) 0x00001A4 (420)	Microsoft ACPI-Compliant System
 (ISA) 0x00001A5 (421)	Microsoft ACPI-Compliant System
 (ISA) 0x00001A6 (422)	Microsoft ACPI-Compliant System
 (ISA) 0x00001A7 (423)	Microsoft ACPI-Compliant System
(ISA) 0x00001A8 (424)	Microsoft ACPI-Compliant System
(ISA) 0x00001A9 (425)	Microsoft ACPI-Compliant System
(ISA) 0x00001AA (426)	Microsoft ACPI-Compliant System
(ISA) 0x00001AB (427)	Microsoft ACPI-Compliant System

 (ISA) 0x000001AC (428)	Microsoft ACPI-Compliant System
 (ISA) 0x000001AD (429)	Microsoft ACPI-Compliant System
 (ISA) 0x000001AE (430)	Microsoft ACPI-Compliant System
 (ISA) 0x000001AF (431)	Microsoft ACPI-Compliant System
 (ISA) 0x000001B0 (432)	Microsoft ACPI-Compliant System
 (ISA) 0x000001B1 (433)	Microsoft ACPI-Compliant System
 (ISA) 0x000001B2 (434)	Microsoft ACPI-Compliant System
 (ISA) 0x000001B3 (435)	Microsoft ACPI-Compliant System
 (ISA) 0x000001B4 (436)	Microsoft ACPI-Compliant System
 (ISA) 0x000001B5 (437)	Microsoft ACPI-Compliant System
 (ISA) 0x000001B6 (438)	Microsoft ACPI-Compliant System
 (ISA) 0x000001B7 (439)	Microsoft ACPI-Compliant System
 (ISA) 0x000001B8 (440)	Microsoft ACPI-Compliant System
 (ISA) 0x000001B9 (441)	Microsoft ACPI-Compliant System
 (ISA) 0x000001BA (442)	Microsoft ACPI-Compliant System
 (ISA) 0x000001BB (443)	Microsoft ACPI-Compliant System
 (ISA) 0x000001BC (444)	Microsoft ACPI-Compliant System
 (ISA) 0x000001BD (445)	Microsoft ACPI-Compliant System
 (ISA) 0x000001BE (446)	Microsoft ACPI-Compliant System
 (ISA) 0x000001BF (447)	Microsoft ACPI-Compliant System
 (ISA) 0x000001C0 (448)	Microsoft ACPI-Compliant System
 (ISA) 0x000001C1 (449)	Microsoft ACPI-Compliant System
 (ISA) 0x000001C2 (450)	Microsoft ACPI-Compliant System
 (ISA) 0x000001C3 (451)	Microsoft ACPI-Compliant System
 (ISA) 0x000001C4 (452)	Microsoft ACPI-Compliant System
 (ISA) 0x000001C5 (453)	Microsoft ACPI-Compliant System
 (ISA) 0x000001C6 (454)	Microsoft ACPI-Compliant System
 (ISA) 0x000001C7 (455)	Microsoft ACPI-Compliant System
 (ISA) 0x000001C8 (456)	Microsoft ACPI-Compliant System
 (ISA) 0x000001C9 (457)	Microsoft ACPI-Compliant System
 (ISA) 0x000001CA (458)	Microsoft ACPI-Compliant System
 (ISA) 0x000001CB (459)	Microsoft ACPI-Compliant System
 (ISA) 0x000001CC (460)	Microsoft ACPI-Compliant System
 (ISA) 0x000001CD (461)	Microsoft ACPI-Compliant System
 (ISA) 0x000001CE (462)	Microsoft ACPI-Compliant System
 (ISA) 0x000001CF (463)	Microsoft ACPI-Compliant System
 (ISA) 0x000001D0 (464)	Microsoft ACPI-Compliant System
 (ISA) 0x000001D1 (465)	Microsoft ACPI-Compliant System
 (ISA) 0x000001D2 (466)	Microsoft ACPI-Compliant System
 (ISA) 0x000001D3 (467)	Microsoft ACPI-Compliant System
 (ISA) 0x000001D4 (468)	Microsoft ACPI-Compliant System
 (ISA) 0x000001D5 (469)	Microsoft ACPI-Compliant System
 (ISA) 0x000001D6 (470)	Microsoft ACPI-Compliant System
 (ISA) 0x000001D7 (471)	Microsoft ACPI-Compliant System
 (ISA) 0x000001D8 (472)	Microsoft ACPI-Compliant System
 (ISA) 0x000001D9 (473)	Microsoft ACPI-Compliant System
 (ISA) 0x000001DA (474)	Microsoft ACPI-Compliant System
 (ISA) 0x000001DB (475)	Microsoft ACPI-Compliant System
 (ISA) 0x000001DC (476)	Microsoft ACPI-Compliant System
 (ISA) 0x000001DD (477)	Microsoft ACPI-Compliant System
 (ISA) 0x000001DE (478)	Microsoft ACPI-Compliant System

	(ISA) 0x000001DF (479)	Microsoft ACPI-Compliant System
	(ISA) 0x000001E0 (480)	Microsoft ACPI-Compliant System
	(ISA) 0x000001E1 (481)	Microsoft ACPI-Compliant System
	(ISA) 0x000001E2 (482)	Microsoft ACPI-Compliant System
	(ISA) 0x000001E3 (483)	Microsoft ACPI-Compliant System
	(ISA) 0x000001E4 (484)	Microsoft ACPI-Compliant System
	(ISA) 0x000001E5 (485)	Microsoft ACPI-Compliant System
	(ISA) 0x000001E6 (486)	Microsoft ACPI-Compliant System
	(ISA) 0x000001E7 (487)	Microsoft ACPI-Compliant System
	(ISA) 0x000001E8 (488)	Microsoft ACPI-Compliant System
	(ISA) 0x000001E9 (489)	Microsoft ACPI-Compliant System
	(ISA) 0x000001EA (490)	Microsoft ACPI-Compliant System
	(ISA) 0x000001EB (491)	Microsoft ACPI-Compliant System
	(ISA) 0x000001EC (492)	Microsoft ACPI-Compliant System
	(ISA) 0x000001ED (493)	Microsoft ACPI-Compliant System
	(ISA) 0x000001EE (494)	Microsoft ACPI-Compliant System
	(ISA) 0x000001EF (495)	Microsoft ACPI-Compliant System
	(ISA) 0x000001F0 (496)	Microsoft ACPI-Compliant System
	(ISA) 0x000001F1 (497)	Microsoft ACPI-Compliant System
	(ISA) 0x000001F2 (498)	Microsoft ACPI-Compliant System
	(ISA) 0x000001F3 (499)	Microsoft ACPI-Compliant System
	(ISA) 0x000001F4 (500)	Microsoft ACPI-Compliant System
	(ISA) 0x000001F5 (501)	Microsoft ACPI-Compliant System
	(ISA) 0x000001F6 (502)	Microsoft ACPI-Compliant System
	(ISA) 0x000001F7 (503)	Microsoft ACPI-Compliant System
	(ISA) 0x000001F8 (504)	Microsoft ACPI-Compliant System
	(ISA) 0x000001F9 (505)	Microsoft ACPI-Compliant System
	(ISA) 0x000001FA (506)	Microsoft ACPI-Compliant System
	(ISA) 0x000001FB (507)	Microsoft ACPI-Compliant System
	(ISA) 0x000001FC (508)	Microsoft ACPI-Compliant System
	(ISA) 0x000001FD (509)	Microsoft ACPI-Compliant System
	(ISA) 0x000001FE (510)	Microsoft ACPI-Compliant System
	(ISA) 0x000001FF (511)	Microsoft ACPI-Compliant System
	(PCI) 0x00000010 (16)	High Definition Audio Controller
	(PCI) 0x00000013 (19)	Intel(R) Active Management Technology - SOL (COM5)
	(PCI) 0xFFFFFFF6 (-10)	Intel(R) Ethernet Connection (13) I219-LM
	(PCI) 0xFFFFFFF7 (-9)	Intel(R) Ethernet Controller (3) I225-LM
	(PCI) 0xFFFFFFF8 (-8)	Intel(R) Ethernet Controller (3) I225-LM
	(PCI) 0xFFFFFFF9 (-7)	Intel(R) Ethernet Controller (3) I225-LM
	(PCI) 0xFFFFF7FA (-6)	Intel(R) Ethernet Controller (3) I225-LM
	(PCI) 0xFFFFF7FB (-5)	Intel(R) Ethernet Controller (3) I225-LM
	(PCI) 0xFFFFF7FC (-4)	Intel(R) Iris(R) Xe Graphics
	(PCI) 0xFFFFF7FD (-3)	Intel(R) USB 3.10 eXtensible Host Controller - 1.20 (Microsoft)
	(PCI) 0xFFFFF7FE (-2)	Standard SATA AHCI Controller

A.3 Memory Address Map

Memory	
[0000000000A0000 - 0000000000BFFFF]	PCI Express Root Complex
[0000000040000000 - 00000000403FFFF]	Motherboard resources
[000000004F400000 - 000000004F6FFFF]	Intel(R) PCI Express Root Port #10 - A0B1
[000000004F400000 - 00000000BFFFFFFF]	PCI Express Root Complex
[000000004F500000 - 000000004F5FFFF]	Intel(R) Ethernet Controller (3) I225-LM
[000000004F600000 - 000000004F603FFF]	Intel(R) Ethernet Controller (3) I225-LM
[000000004F720000 - 000000004F721FFF]	Standard SATA AHCI Controller
[000000004F722000 - 000000004F7227FF]	Standard SATA AHCI Controller
[000000004F723000 - 000000004F7230FF]	Standard SATA AHCI Controller
[0000000080400000 - 00000000806FFFF]	Intel(R) PCI Express Root Port #10 - A0B1
[0000000080500000 - 00000000805FFFF]	Intel(R) Ethernet Controller (3) I225-LM #2
[0000000080600000 - 0000000080603FFF]	Intel(R) Ethernet Controller (3) I225-LM #2
[0000000090000000 - 000000009FFFFFFF]	Microsoft Basic Display Adapter
[00000000A0000000 - 00000000A0FFFFFFF]	Microsoft Basic Display Adapter
[00000000A1100000 - 00000000A111FFFF]	Intel(R) I211 Gigabit Network Connection
[00000000A1100000 - 00000000A111FFFF]	Intel(R) PCI Express Root Port #16 - 9DB7
[00000000A1120000 - 00000000A1123FFF]	Intel(R) I211 Gigabit Network Connection
[00000000A1200000 - 00000000A120FFFF]	Intel(R) USB 3.1 eXtensible Host Controller - 1.10 (Microsoft)
[00000000A121C000 - 00000000A121DFFF]	Standard SATA AHCI Controller
[00000000A1220000 - 00000000A1221FFF]	PCI Serial Port
[00000000A1222000 - 00000000A12220FF]	Intel(R) SMBus - 9DA3
[00000000A1223000 - 00000000A1223FFF]	Intel SD Host Controller
[00000000A1226000 - 00000000A12267FF]	Standard SATA AHCI Controller
[00000000A1227000 - 00000000A12270FF]	Standard SATA AHCI Controller
[00000000BFDF0000 - 00000000BFFDFFFF]	Intel(R) Active Management Technology - SOL (COM5)
[00000000BFEE0000 - 00000000BFFFFFFF]	Intel(R) Ethernet Connection (13) I219-LM
[00000000C0000000 - 00000000CFFFFFFF]	Motherboard resources
[00000000E0000000 - 00000000EFFFFFFF]	Microsoft Basic Display Adapter
[00000000F0000000 - 00000000F0003FFF]	Realtek PCIe GBE Family Controller #2
[00000000F0000000 - 00000000F00FFFFF]	PCI Express Root Port
[00000000F0100000 - 00000000F0103FFF]	Realtek PCIe GBE Family Controller
[00000000F0100000 - 00000000F01FFFFF]	PCI Express Root Port
[00000000F7800000 - 00000000F7BFFFFF]	Microsoft Basic Display Adapter
[00000000F7C00000 - 00000000F7C00FFF]	Realtek PCIe GBE Family Controller #2
[00000000F7C00000 - 00000000F7CFFFFF]	PCI Express Root Port
[00000000F7D00000 - 00000000F7D00FFF]	Realtek PCIe GBE Family Controller
[00000000F7D00000 - 00000000F7DFFFFF]	PCI Express Root Port
[00000000F7E00000 - 00000000F7E0FFFF]	Intel(R) USB 3.0 eXtensible Host Controller - 1.0 (Microsoft)
[00000000F7E19000 - 00000000F7E190FF]	SM Bus Controller
[00000000F7E1A000 - 00000000F7E1A7FF]	Standard SATA AHCI Controller
[00000000F7E1B000 - 00000000F7E1B3FF]	Intel(R) 8 Series/C220 Series USB EHCI #1 - 8C26
[00000000F7E1C000 - 00000000F7E1C3FF]	Intel(R) 8 Series/C220 Series USB EHCI #2 - 8C2D
[00000000F7E1E000 - 00000000F7E1E0FF]	PCI Simple Communications Controller
[00000000FD000000 - 00000000FD68FFFF]	Motherboard resources
[00000000FD690000 - 00000000FD69FFFF]	Intel(R) GPIO Controller - 34C5
[00000000FD6A0000 - 00000000FD6AFFFF]	Intel(R) GPIO Controller - 34C5
[00000000FD6AE000 - 00000000FD6AFFFF]	Intel(R) Serial IO GPIO Host Controller - INT34BB
[00000000FD6B0000 - 00000000FD6CFFFF]	Motherboard resources
[00000000FD6D0000 - 00000000FD6DFFFF]	Intel(R) GPIO Controller - 34C5
[00000000FD6D0000 - 00000000FD6DFFFF]	Intel(R) Serial IO GPIO Host Controller - INT34BB

	[00000000FD6E0000 - 00000000FD6EFFFF]	Intel(R) GPIO Controller - 34C5
	[00000000FD6E0000 - 00000000FD6EFFFF]	Intel(R) Serial IO GPIO Host Controller - INT34BB
	[00000000FD6F0000 - 00000000FDFFFFFF]	Motherboard resources
	[00000000FE000000 - 00000000FE01FFFF]	Motherboard resources
	[00000000FE010000 - 00000000FE010FFF]	Intel(R) SPI (flash) Controller - A0A4
	[00000000FE010000 - 00000000FE010FFF]	Intel(R) SPI (flash) Controller - 9DA4
	[00000000FE04C000 - 00000000FE04FFFF]	Motherboard resources
	[00000000FE050000 - 00000000FE0AFFFF]	Motherboard resources
	[00000000FE0D0000 - 00000000FE0FFFFF]	Motherboard resources
	[00000000FE200000 - 00000000FE77FFFF]	Motherboard resources
	[00000000FED00000 - 00000000FED003FF]	High precision event timer
	[00000000FED20000 - 00000000FED7FFFF]	Motherboard resources
	[00000000FED40000 - 00000000FED44FFF]	System board
	[00000000FED40000 - 00000000FED44FFF]	Trusted Platform Module 2.0
	[00000000FED45000 - 00000000FED8FFFF]	Motherboard resources
	[00000000FED90000 - 00000000FED93FFF]	Motherboard resources
	[00000000FEDA0000 - 00000000FEDA0FFF]	Motherboard resources
	[00000000FEDA1000 - 00000000FEDA1FFF]	Motherboard resources
	[00000000FEDC0000 - 00000000FEDC7FFF]	Motherboard resources
	[00000000FEE00000 - 00000000FEEFFFFFFF]	Motherboard resources
	[00000000FF000000 - 00000000FFFFFFFF]	Legacy device
	[00000000FF000000 - 00000000FFFFFFFF]	Motherboard resources
	[0000004000000000 - 000000400FFFFFFF]	Intel(R) Iris(R) Xe Graphics
	[0000006000000000 - 0000006000FFFFFFF]	Intel(R) Iris(R) Xe Graphics
	[0000006001A00000 - 0000006001A0FFFF]	Intel(R) USB 3.10 eXtensible Host Controller - 1.20 (Microsoft)
	[0000006001A18000 - 0000006001A180FF]	Intel(R) SMBus - A0A3
	[0000006001A19000 - 0000006001A19FFF]	PCI Simple Communications Controller
	[0000006002340000 - 000000600234FFFF]	Intel(R) USB 3.10 eXtensible Host Controller - 1.20 (Microsoft)
	[0000006002350000 - 000000600235FFFF]	Intel(R) USB 3.10 eXtensible Host Controller - 1.20 (Microsoft)
	[0000006002360000 - 0000006002367FFF]	PCI Data Acquisition and Signal Processing Controller
	[00000077FFFEFC000 - 00000077FFFEFFFFF]	High Definition Audio Controller
	[00000077FFFF00000 - 00000077FFFFFFFFFFF]	High Definition Audio Controller