

PREMIUM BEACH

CHAIRS

TOMMY CHAIR.

SLING CHAIRS.

2 PIECE CHAIR

USER GUIDE & TIPS



business & pleasure co.



Sit Back & Relax.

Our chairs are made with the finest quality materials and attention to detail, ensuring they are as beautiful as they are practical. Enjoy on the beach, at home or in the park.

TOMMY CHAIR SET UP

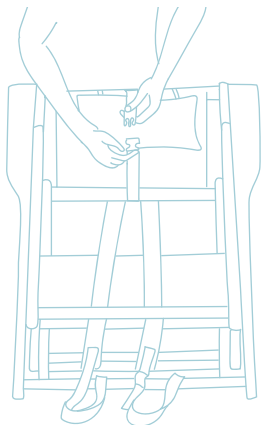

1. UNDO

Unclip plastic buckle on the strap.

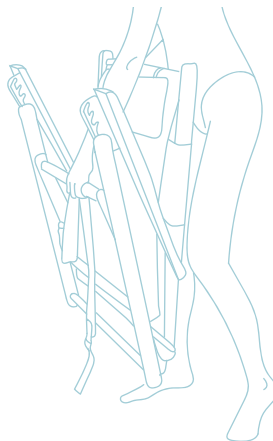

2. OPEN

Standing behind the chair, let the seat down.

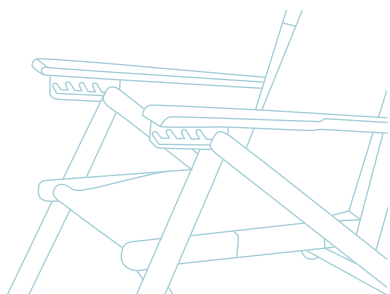

3. CHECK

Ensure both arms are at the same recline setting before sitting down.

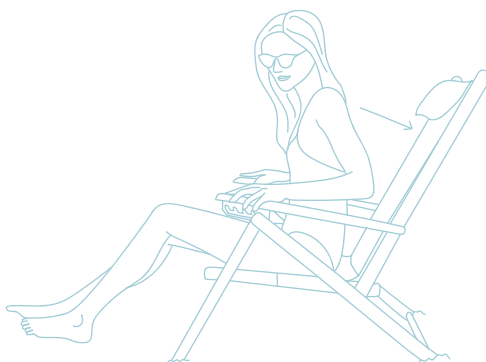

4. SIT & RECLINE

Lift arms up and lean back to recline!

TOMMY CHAIR TIPS

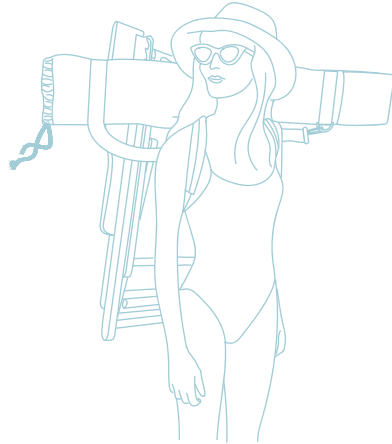
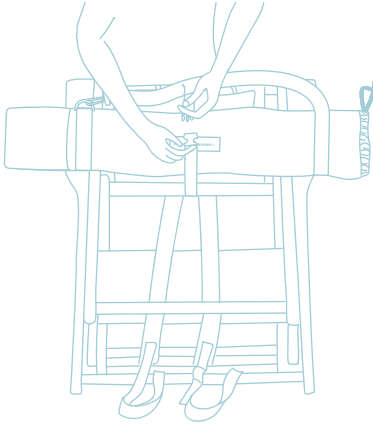

CARRY TIPS

Add your umbrella under the closure strap to free up your hands

WARNING!

1. WATCH STEP

Avoid stepping on the cross bar when getting up.

2. WATCH FINGERS

Keep fingers clear of the recline mechanism.

3. LOOK AFTER YOUR CHAIR

Avoid sitting on armrests, standing on seat or backrest and be mindful of this chair's recommended weight limit.

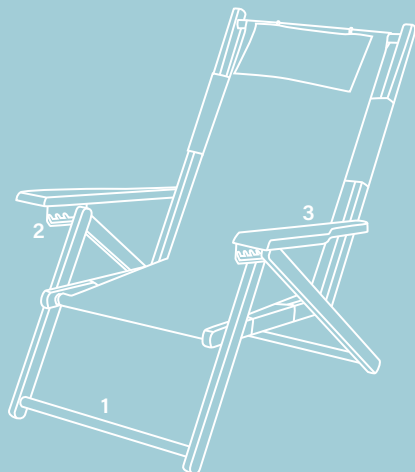

2 PC CHAIR SET UP

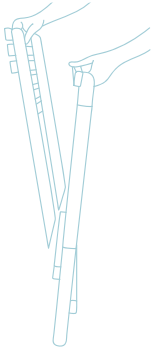

1. OPEN

Use one hand on each part, pull the seat up.

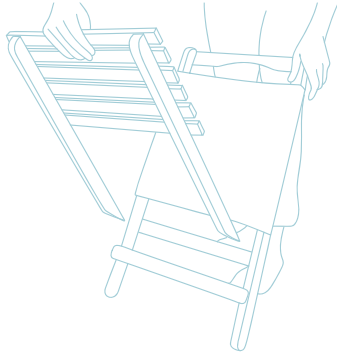

2. SLIDE SEAT IN

Ensure the seat is all the way in before sitting

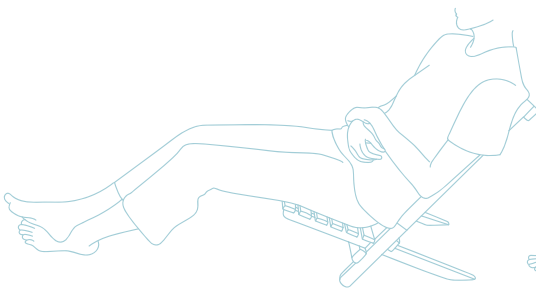
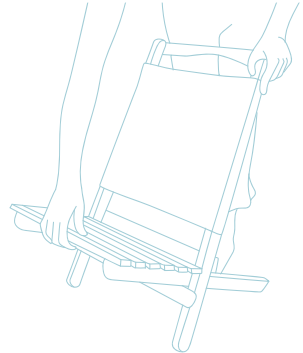

3. SIT & RELAX

Sit back and relax. Make sure bottom is at the back of the seat to avoid tipping

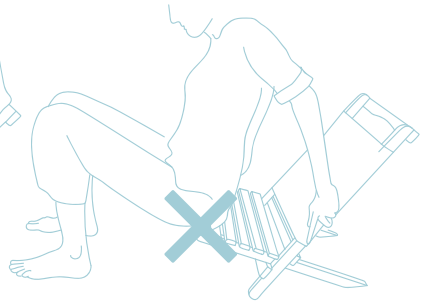

IMPORTANT!

Do not sit on the edge of the seat!

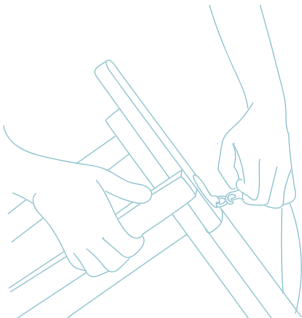

4. PACK & CARRY

Clip on carry strap (found in back pocket) and sling over your shoulder.

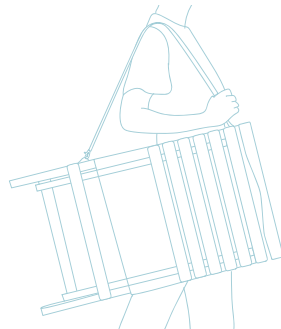

SLING CHAIR SET UP

(ALSO USE FOR MINI-SLING SETUP)

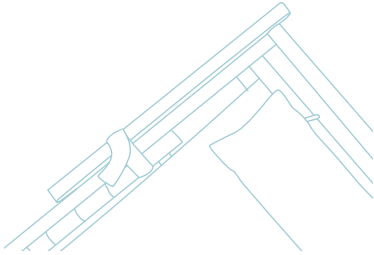

1. UNDO

Undo velcro straps. These are only needed for transport to stop the chair opening

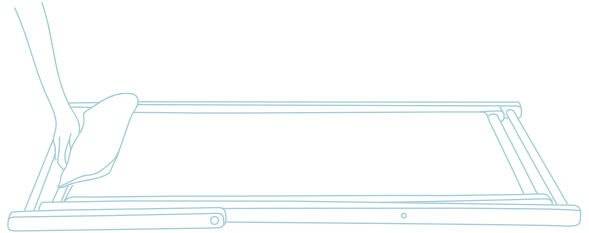

2. OPEN

Starting flat with pillow facing up, lift the part with the pillow. Watch your fingers!

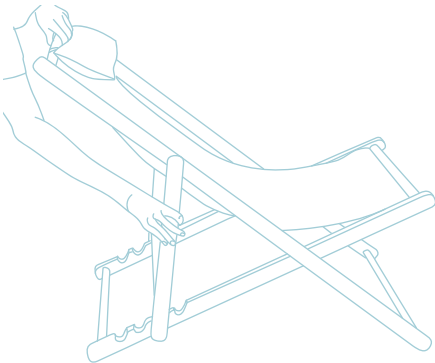

3. SET RECLINE

Slot the cross bar into the notches. Making sure both sides at the same recline.

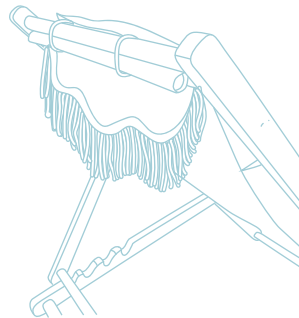

4. CHECK

Check the poles are in place and sling is secure.

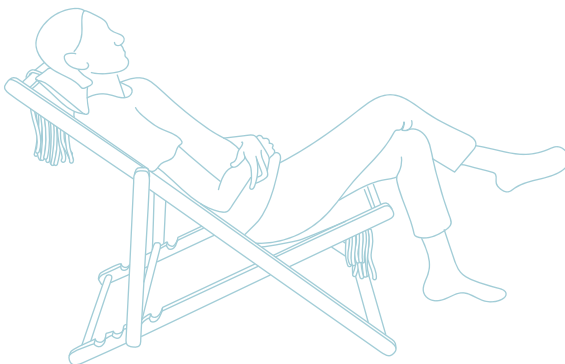

5. SIT BACK & RELAX

IMPORTANT INFORMATION!

Please read the following before use of your B&PCo Chair

Do not sit on the edge of your chair

Set up and use of a Business & Pleasure Co product must follow the "Set Up" instruction guide

Business & Pleasure Co. are not responsible for the miss use or poorly set up products that lead to damage or harm to any persons or property.

For all warranty information, please visit
www.businessandpleasureco.com

CARE INSTRUCTIONS.

1. To maintain and extend the life of your product keep it dry and clean of any salt, sand, chlorine or chemical residue.
2. If your chair gets wet, let it air-dry before packing way.
3. To help extend the life of your print and material store it away when not in use to reduce un-nessesary and excessive exposure to direct sunlight causing fading and material deterioration.
4. Always store strap in back pocket when not in use to avoid creating a trip hazard.

GOT QUESTIONS?

Email orders@businessandpleasureco.com
Or vist www.businessandpleasureco.com

FEATURES



PORTABLE

STYLISH AND PRACTICAL, OUR CHAIRS CAN BE SET UP ALMOST ANYWHERE. BEACH, PARK OR POOLSIDE.



PREMIUM HARDWOOD

WORLD FORESTRIES CERTIFIED
HARDWOOD



PREMIUM CANVAS

UV & WATER TREATED CANVAS
COTTON BULLION FRINGE