

# ALL AMERICAN

## OPERATING INSTRUCTIONS

### Models 50X & 75X Electric Pressure Steam Sterilizers



50X shown with optional support base, Part No. 2180



75X shown with optional support base, Part No. 4180



## CAUTION! READ THESE IMPORTANT SAFEGUARDS!

FAILURE TO FOLLOW INSTRUCTIONS AND/OR IMPROPER USE MAY RESULT IN SCALDING, BODILY INJURIES OR EXPLOSION.

When using the pressure steam sterilizer, basic safety precautions should always be followed:

1. Read and understand the instruction manual *before* operating unit for the first time.
2. Unit will become hot during use. Do not touch hot surfaces. Always use caution when handling unit when it is hot.
3. Closely supervise children if the sterilizer is used near children.
4. Extreme caution must be used when moving the sterilizer containing hot liquids.
5. Do not use the sterilizer for other than its intended use.
6. Whenever possible only use distilled or deionized water in sterilizer.

7. Always check the pressure release devices for clogs before using your sterilizer.

8. This and every steam sterilizer operates under pressure. Improper use may result in scalding injury. Make certain to read operating instructions before first use and that the unit must be properly closed before operating to prevent possible injury.

9. Before each use make sure that your gauge reads zero.

10. **NEVER** loosen wing nuts until the steam pressure gauge reaches zero and have allowed remaining pressure to escape by opening the control valve in the vertical "open" position.

11. **NEVER** open the sterilizer until the unit has cooled and the internal pressure reads zero on the steam pressure gauge.

12. **NEVER** use this sterilizer for cooking or processing food.

13. **NEVER** run the unit without water. Doing so will damage the heating element.

14. **NEVER** move your sterilizer while it is pressurized.

15. Be sure to keep metal-to-metal seal lubricated.

16. Do not subject your sterilizer to sudden extreme temperature changes, as this may cause expansion or contraction of the metal which can damage any aluminum device. Do not move sterilizer from a cold storage area directly onto a hot flame or element. Do not add cold water to a sterilizer which has been boiled dry and remains hot. Do not cool sterilizer by pouring cold water into or on the unit.

17. As in all clinical/laboratory settings, wear safety glasses when attending to your sterilizer.

**SAVE THESE INSTRUCTIONS**

# Operating Instructions for Model 50X/75X Electric Pressure Steam Sterilizer

**IMPORTANT: DO NOT OPERATE THIS PRESSURE STEAM STERILIZER UNTIL YOU HAVE THOROUGHLY READ THESE OPERATING INSTRUCTIONS.**

## Please Note:

This unit has been steam pressure tested at the factory and approved. The slight discoloration on the inside of the unit is caused by the hot steam test.

## CLEANING

When you are done using your sterilizer, you need to empty the water from the unit, rinse thoroughly and dry completely. This procedure needs to be done daily. Do not leave water in the unit overnight. Rinse thoroughly between water changes. Store your sterilizer in a dry area. On your next use, fill the sterilizer with clean distilled water. Distilled water is the recommended water. If distilled water is not available, then you may use your local water. If your local water supply contains lime or high levels of minerals, the unit will require periodic cleaning to remove and prevent the buildup of deposits.

Units should be cleaned whenever there is a buildup of lime or mineral deposits. After many cycles, a white deposit may begin to form on the bottom of the sterilizer. We recommend cleaning with a lime remover. Manufacturers of coffee makers have cleaning solutions which may be used. There are also solutions available at your local hardware and drug stores that can be used to clean aluminum. Follow the manufacturer's instructions and make up a solution of the cleaner, filling your sterilizer above the standard operating level. Let the sterilizer stand a few minutes then rinse thoroughly. You may have to repeat this procedure a few times to fully remove the lime and mineral deposits from your sterilizer.

**Never turn the sterilizer "on" when filled with a cleaning solution.**

You may also use standard white vinegar to clean your sterilizer. Fill your sterilizer above the standard operating level with vinegar and let it stand a few minutes then rinse thoroughly. You may have to repeat this procedure a few times to fully remove the lime and mineral deposits from your sterilizer.

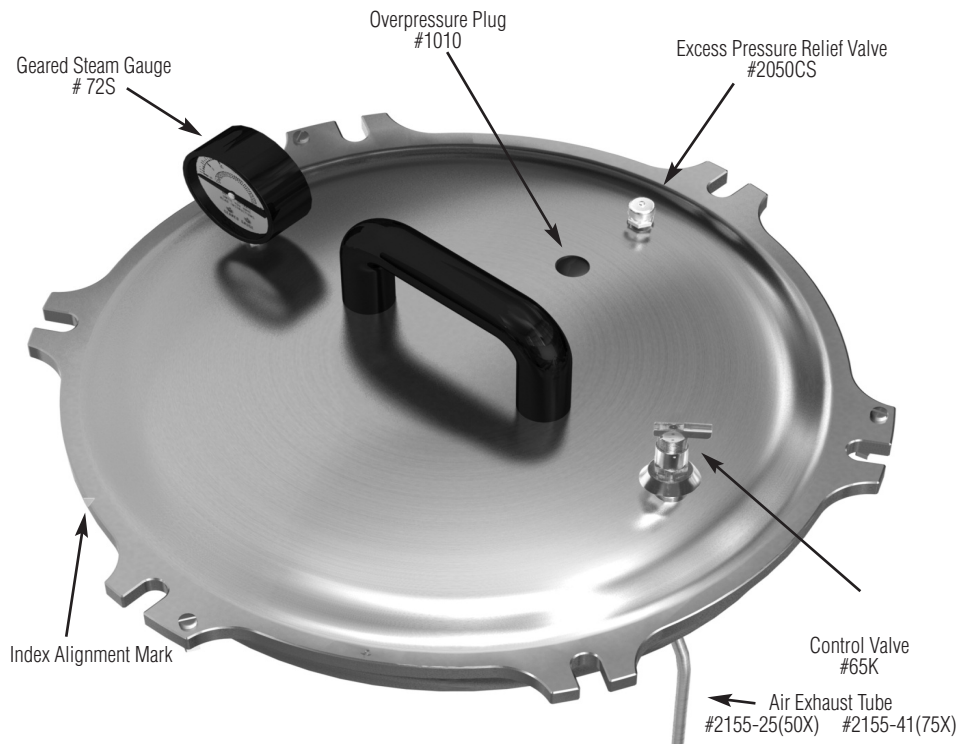

## ALLOWABLE OPERATING ENVIRONMENTS

This unit was designed to operate in an indoor environment between 5° and 40° Celsius or 41° and 104° Fahrenheit. An allowable pollution degree per IEC 664 cannot exceed a rating of two. The allowable relative humidity levels are 80% for temperatures up to 31°C (88°F) and decreasing linearly to 50% at 40°C (104°F).

### Elevation above sea level.

At altitudes greater than sea level, settings need to be adequately adjusted to compensate for the effect of altitude on the boiling point of water. We suggest you increase pressure by 0.5psi for every 1000 ft. of elevation above sea level.

City Altitude	Steam Pressure Required
Sea level	15-17 psi
2000ft	16-18 psi
4000ft	17-19 psi
6000ft	18-20 psi
8000ft	19-21 psi
10,000ft	20-22 psi

The power cord supplied with this unit is a 3-pronged grounded plug. This plug is intended to be used with a standard 3-prong grounded wall receptacle to minimize the possibility of electric shock hazard from this unit. Do not for any reason cut off the grounding prong or use a 2-prong adapter plug. This unit is rated to be operated using local consumer electrical power. It has a transient over voltage rating of II. The 120V unit is designed to operate at a frequency of 50/60 Hz with a line of voltage of 115 volts AC +/- 10%. The 240V unit is designed to operate at a frequency of 50/60 Hz with a line voltage of 230 volts AC +/- 5%.

**If in doubt, the user should have the wall receptacle and circuit checked by a qualified electrician to make sure the receptacle can provide adequate current and voltage, and is properly grounded.**

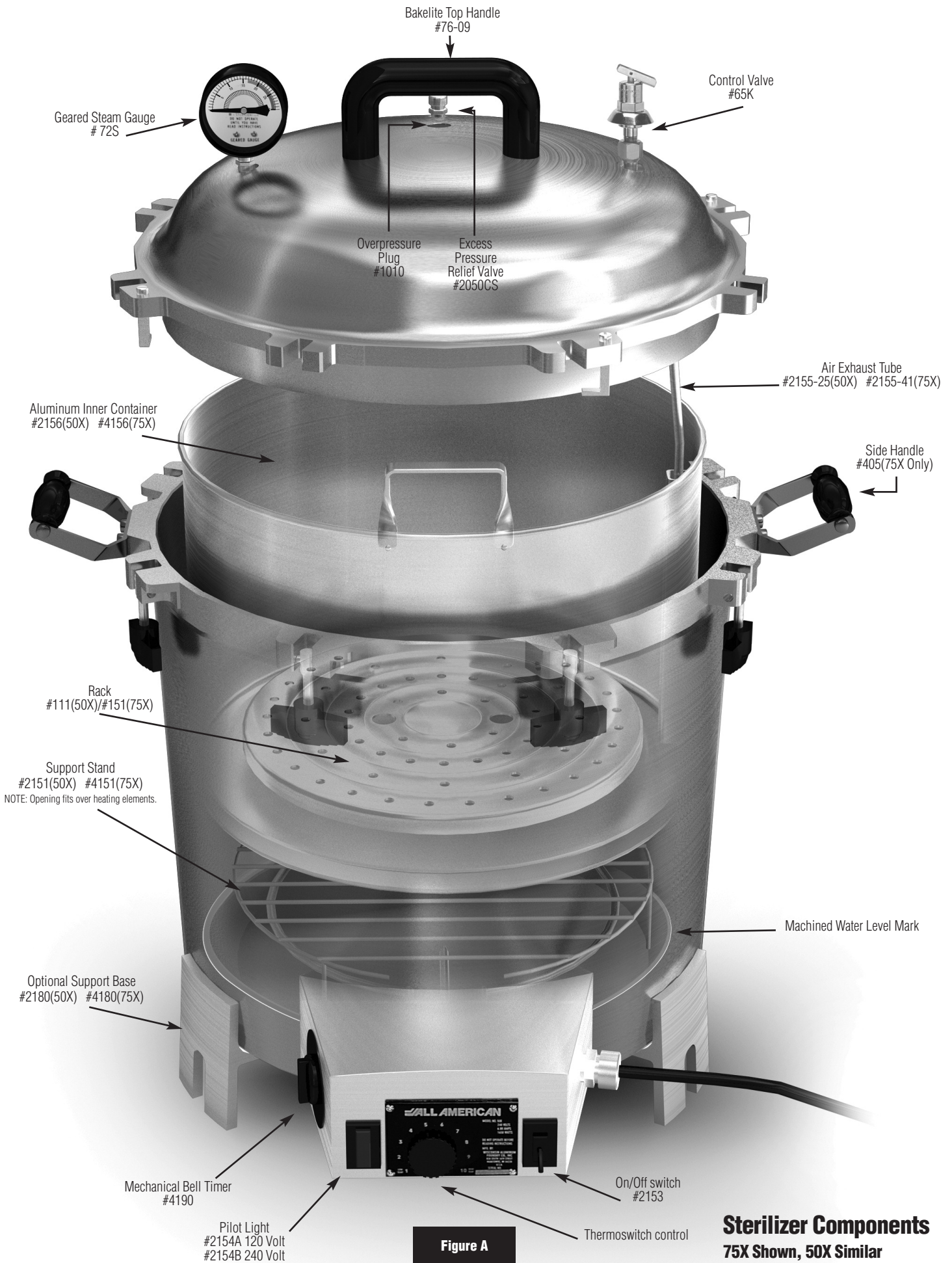



## OPERATION

1. Place sterilizer on a stable, heat tolerant surface with access to appropriate electrical power.

2. Remove the cover of the sterilizer by turning the wing nuts in a counter-clockwise motion. Always undo two opposite wing nuts at a time. Turn cover and remove cover from bottom. Next remove inner container and inner container rack from sterilizer bottom (See Fig. A).

3. **LUBRICATE METAL-TO-METAL SEAL** Apply lubrication to the entire beveled edge of the bottom (See Fig. 1). We recommend using a high temperature lubricant like high vacuum grease;

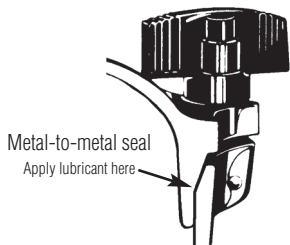

Fig. 1

petroleum jelly may also be used as a substitute. Only a thin film of lubrication is needed to lubricate the metal-to-metal seal.

4. Place distilled or deionized water up to the water line machined into the bottom of the sterilizer. Water must be directly over the heating element and **NOT** inside the inner container. Next, place the inner container rack inside the inner container with the lip side down (See Fig. A). The purpose of the inner container rack is to provide an air space at the bottom of the inner container so that air may be evacuated and steam is allowed to circulate freely throughout the entire chamber.

5. With the inner container and inner container rack out of the sterilizer place articles to be sterilized inside the inner container on top of the inner container rack. You may wish to place the articles to be sterilized inside plastic bags specifically designed for use inside steam sterilizers. Arrange items so that steam may circulate freely inside the chamber during the sterilization cycle.

Also, you can place a towel or cloth on top of the items inside the container to absorb any moisture that may drip down from the cover onto the items.

6. Check to see if your water level inside the sterilizer is correct and then place loaded inner container inside the sterilizer.

7. **VERY IMPORTANT** – make sure that the air exhaust channel (located on the inside of the inner container) is positioned on the right side of the sterilizer. This is necessary so that when the cover is placed on the unit you can guide the air exhaust tube into the air exhaust tube channel (See Fig. A).

8. Place the cover of the sterilizer making sure that that index alignment arrow on the cover aligns with the index line arrow on the side of the bottom; **AND** that the air exhaust tube is inserted into the air exhaust tube channel on the inner container. With the cover aligned with the bottom and the air exhaust tube inside the air exhaust channel you may tighten the wing nuts on the cover. Be sure to tighten wing nuts evenly, always tightening down two opposite wing nuts at one time. As you are tightening the wing nuts be sure to maintain an even gap between the cover and the bottom. Loosen or tighten the wing nuts accordingly to maintain an even gap. This will draw the cover down evenly and ensure a proper seal. **NEVER USE A WRENCH OR ANY MECHANICAL DEVICE TO TIGHTEN WING NUTS. NEVER HAMMER OR STRIKE THE WING NUTS OR COVER WHILE OPENING OR CLOSING UNIT.**



9. Plug power supply cord into the proper outlet 120V or 240V (refer to dial plate on front of the

control box and note in the upper left hand corner if your unit is 120V or 240V). Next, turn the on/off toggle switch to “on” position, the red pilot light should be illuminated indicating that electrical current is working and the heating element is now operating. To increase heat, turn the heat control knob in a clockwise direction; to reduce heat, turn knob in a counter-clockwise direction. Always maintain a close watch on the pressure gauge and adjust heat accordingly.

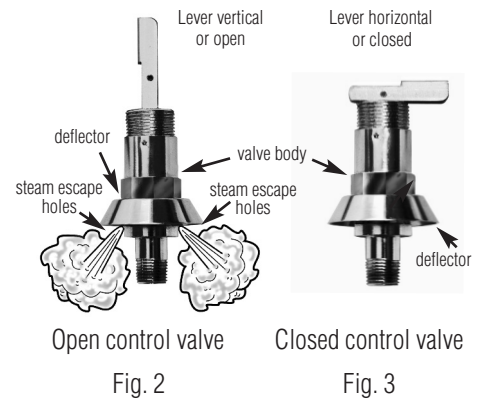

Fig. 2

Fig. 3

10. **OPEN CONTROL VALVE** (See Fig. 2) by moving the lever into the upright position. Steam generated by the sterilizer will be drawn from the bottom of the unit up through the air exhaust tube and out the control valve. **STEAM MUST CONTINUOUSLY ESCAPE FROM THE CONTROL VALVE FOR AT LEAST 5 MINUTES.** Once this has occurred, **CLOSE THE VALVE AND LET PRESSURE BUILD UNTIL THE GAUGE READS IN THE “GREEN” STERILIZATION ZONE**, which is between 17 to 21 PSI or 121°C/250°F to 127°C/259°F. Once you have completed the above, **OPEN THE CONTROL VALVE A SECOND TIME AND VENT THE CHAMBER FOR AN ADDITIONAL 3 TO 5 MINUTES.** Please Note that the greatest reason for a sterilization failure is trapped air in the chamber of the sterilizer. Trapped air may prevent the steam from permeating the contents to be sterilized.

11. Once the chamber is properly vented, close the 65k Control Value, then the sterilization cycle may begin. Start timing the sterilization cycle when the gauge needle is in the green sterilization zone on the face of the gauge between 17-21 PSI. We recommend running a sterilization cycle of not less than 35 minutes at a temperature of no less 121°C/250°F. Your



sterilizer is equipped with a mechanical bell timer located on the left side of the control unit. This mechanical timer is not connected to any electrical circuit and will not turn the unit on or



off. ALWAYS MONITOR THE GAUGE DURING THE CYCLE MAKING SURE THAT THE PRESSURE REMAINS IN THE GREEN STERILIZATION ZONE ON THE FACE OF THE GAUGE. We highly recommend that you use steam integrator strips in your sterilizer to ensure that you have run a successful sterilization cycle.

12. At the end of the sterilization cycle, turn the on/off toggle switch to the "off" position and open the control valve into the open position (See Fig. 2) to allow the steam to escape. The valve will be hot after the cycle, to avoid injury always use heat resistant gloves to open the valve. Continue monitoring the gauge until it reaches **0 PSI** and no sound of escaping steam can be heard coming through the control valve. NEVER ATTEMPT TO OPEN THE STERILIZER UNTIL THE GAUGE READS ZERO.

13. With the pressure gauge reading 0 PSI loosen the wing nuts evenly by turning two opposite wing nuts counter clockwise. The wing nuts may still be hot, we recommend wearing heat resistant gloves to avoid potential burns. With the wing nuts removed, remove the cover by turning it counter clockwise. Remember when removing the cover always tilt and angle the cover away from yourself or other people to prevent injury from any remaining steam in the chamber. PLEASE NOTE, when the sterilizer is allowed to cool with the cover tightened to the bottom this increases the chance that the cover may become stuck to the bottom.

14. With the cover removed the inner container may now be removed. In the event that the inner container remains hot, we recommend using heat resistant gloves to handle the inner container. If the sterilizer is not going to be immediately used again, before storing the unit all water should be emptied from the unit and the inside must be thoroughly dried. We recommend pouring the water out of the unit while it is still warm and leaving the cover off to let the inside of the chamber dry. The residual heat will help dry the unit. For storage, place the cover on the unit and loosely attach the wing nuts. We recommend leaving the control valve open (See Fig. 2) to allow air to circulate through your sterilizer.

15. We have included a sterilization log sheet that we highly recommend using as best practice. The sheet will allow the operator to keep a record of all of the sterilization cycles. The operator should diligently fill out and keep the record safe. Additional sheets can be downloaded from our website.

## MAINTENANCE

1. Metal-to-Metal seal (See Fig. 1). We recommend periodically checking the metal-to-metal seal and lubricating as needed. It is extremely important to keep the seal lubricated

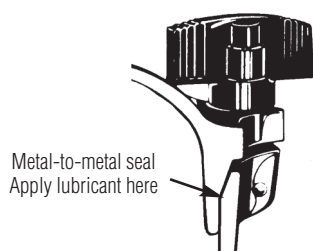

Fig. 1

as failure to do so could cause the cover to stick potentially making it very difficult to remove the cover.

2. PRESSURE GAUGE, PART NO. 72S. (See Fig. 4) Do not immerse your pressure gauge in water when cleaning the unit. The gauge does not require any maintenance other than periodically making sure that the opening of the gauge on the underside of the cover is open and free of any foreign matter. DO NOT USE YOUR UNIT IF

THE GAUGE FACE CRACKS, FILLS WITH STEAM OR DOES NOT RETURN TO ZERO.

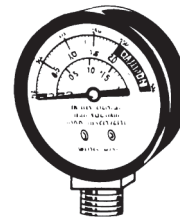
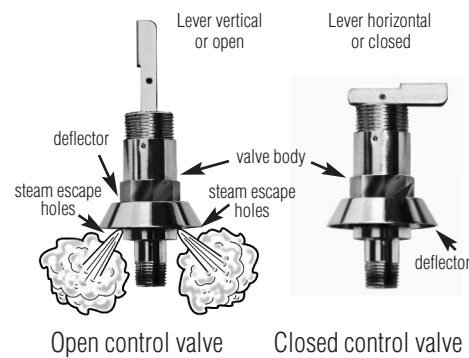

Fig. 4  
Pressure Gauge

3. CONTROL VALVE, PART NO. 65K (See Fig. 2 & 3). To ensure long life and proper operation it is important to periodically clean the control valve thoroughly in hot soapy water. If distilled water is not used, calcification could build up and cause the valve to leak. To clean any built up calcification, put the lever in the open position and soak the valve in vinegar. Be sure to clean the control valve in hot soapy water after soaking in vinegar.

In the event that you are unable to properly remove any foreign material in your control valve, we recommend that the control valve be discarded and replaced with a new control valve.



Open control valve

Closed control valve

Fig. 2

Fig. 3

4. AIR EXHAUST TUBE, PART NO. 2155 (See Fig. 5). It is essential that the air exhaust tube be frequently checked to make sure that air passes freely through it. We recommend that you blow air through the exhaust tube at least once a month to make certain that it is not plugged with any foreign material. Simply



Fig. 5

remove the air exhaust tube from the control valve on the bottom of the sterilizer cover. The

tube may be cleaned using a small diameter wire running through the length of the tube several times. If you notice any difficulty cleaning the air exhaust tube or notice any corrosion on the inside of the passage, we recommend that you discard the tube and replace it with a new one.

5. EXCESS PRESSURE RELIEF VALVE, PART NO. 2050CS (See Fig. 6). Your sterilizer is equipped with a new type of excess pressure relief valve. It is designed for longer, maintenance free service; however, we recommend that the valve be replaced every three years in normal service. The valve is designed to be release pressure at 26 PSI. This valve is equipped with a deflector cap that will direct any steam released in a downward direction. It is possible to manually release steam with the valve by simply grasping the deflector cap and pulling upwards slightly. The deflector cap will be hot so always wear heat resistant gloves when manually venting the unit with the excess pressure relief valve. Once the deflector cap is released, the valve will automatically seal back into place thereby preventing any additional pressure from escaping.

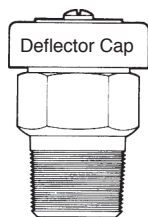
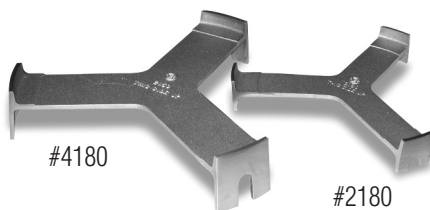

Fig. 6  
Part No. 2050CS  
Excess Pressure  
Relief Valve

overpressure plug and opening should be checked at least once per month. The overpressure plug may be removed using your fingers (NEVER REMOVE THE PLUG WHEN THE STERILIZER IS HOT). Once the plug is removed it is important to clean the opening in the cover where the plug goes to keep it clear of any foreign matter, residue or grease buildup that may occur. Next clean the opening with hot soapy water. After, inspect your plug and make certain that it is in good condition free of cracks, or becomes too hard or deformed. After cleaning reinsert the overpressure plug by pushing the round top side into the opening from the underside of the cover (See Fig. 7).

7. OPTIONAL SUPPORT BASE, PART NO. 2180, (See above photo). This support base is an



accessory that elevates the sterilizer bottom approximately 1 3/8" above the work surface upon which the unit is operated. The support will eliminate any potential heat damage to the work surface as it permits free circulation of air.

6. OVERPRESSURE PLUG, PART NO. 1010 (See Fig. 7). Your sterilizer is also equipped with an overpressure plug which acts as an additional safety device. The plug is designed to automatically release pressure should pressure reach

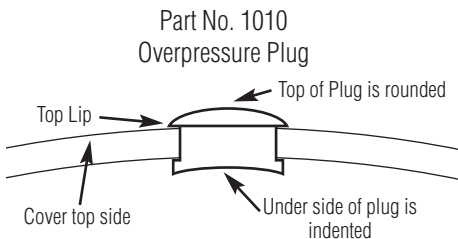
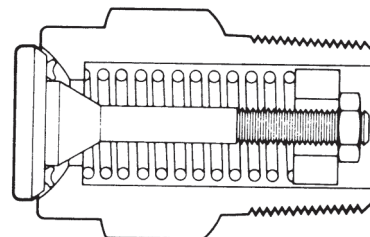

Fig. 7

greater than 30 PSI. The plug is made from silicone and is found on the cover located directly in front of the Excess Pressure Relief Valve. For best performance of the plug and safe operating of your sterilizer, we recommend that you replace your plug every six months. The

## How Part No. 2050CS Works Closed



Resilient seal design prevents leakage. Sealing efficiency increases with increased pressure up to cracking pressure. Metal-to-metal seat on low pressure side supports spring load, prevents sticking.

## Open

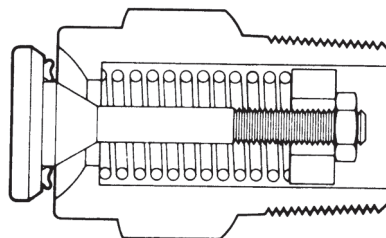

When system pressure overcomes spring force, poppet opens, momentarily exposing variable orifice between poppet and body to pass increasing flow with minimum pressure rise without blowdown.

## Resealing

Resilient seal automatically establishes line of contact with spherical seat. Seal provides dead tight reseal very close to cracking pressure.

**Operating characteristics** of the No. 2050CS excess pressure relief valve are:

- A. Zero leakage to 95-98% of cracking pressure.
- B. Increased sealing efficiency as pressure increases. Resilient "Q" ring seal is forced against metal seat as pressure increases up to set cracking pressure.
- C. Cracking pressure accuracy. Valves are preset to required cracking pressure of 26 PSI.

---

## IMPORTANT STERILIZATION FACTS

Steam is an ideal sterilizing agent because it kills microbes quickly. A large volume of steam condenses to a very small amount of water and more steam is drawn to replace it. This causes excellent penetration of fabrics, papers and certain plastics.

It is essential that this and any steam sterilizer be regularly checked for proper steam penetration throughout the entire chamber of the sterilizer. We recommend using steam sterilization indicator strips that may be purchased at many medical supply retailers. Place the indicator strip in every load to ensure that adequate steam penetration is present in the load thereby assuring a successful sterilization cycle. A melt indicator in a small glass vial is another acceptable way to determine temperature and steam penetration during the cycle. For more information on steam sterilization we recommend going to the Center for Disease Control <http://www.cdc.gov/>.

## PRESSURE GAUGE ACCURACY

The gauges are rated as having an accuracy of 3%-2%-3%. This designates plus or minus 3% of the full span for the first and last quarter of the dial and 2% for the middle of the dial.

## TROUBLE SHOOTING

**Question:** I am having trouble passing a spore test, what am I doing wrong?

**Answer:** Most likely you are not properly venting all the air out of the chamber before you start timing your cycle. Always vent the chamber using the Part 65K Control Valve as outlined in No. 10 of the operating instructions.





## 50X AND 75X ELECTRIC MODEL SPECIFICATIONS



Shown with Optional Support Base\*

### Model 50X (25 qt/24 liter)

**Model 50X-120:** 120 Volt, 50/60 Hz 1650 watts/13.75 amps

**Model 50X-240:** 240 Volt, 50/60 Hz 1650 watts/6.88 amps

<b>Gross Capacity</b>	<b>25 qt/24 liter</b>
Overall Height	16 <sup>3</sup> / <sub>4</sub> "/42.5cm
Bottom Height	12 <sup>1</sup> / <sub>4</sub> "/31.2cm
Inside Diameter	12 <sup>5</sup> / <sub>8</sub> "/32.1cm
Unit Weight	29 lbs./13.2kg

#### Inner Container No. 2156

Height	8 <sup>1</sup> / <sub>2</sub> "/21.6cm
Diameter	11 <sup>1</sup> / <sub>8</sub> "/28.3cm
Circumference	35 <sup>7</sup> / <sub>8</sub> "/91.1cm
Capacity	14.5 qt/13.7 liter
Volume	835in <sup>3</sup> /13,688cm <sup>3</sup>

Carton Dimensions 21" x 17<sup>1</sup>/<sub>2</sub>" x 18<sup>1</sup>/<sub>2</sub>"  
53.4cm x 44.5cm x 47cm

Shipping Weight 34 lb. / 15.4kg

Unit Pack: 1 Cube: 4.28

#### Optional No. 2180 Support Base

Height	2 <sup>1</sup> / <sub>5</sub> cm high
Outside Diameter	12 <sup>3</sup> / <sub>4</sub> "/32.4cm
Inside Diameter	12 <sup>3</sup> / <sub>8</sub> "/31.4cm
Elevates Sterilizer Above Surface	1 <sup>3</sup> / <sub>8</sub> "/3.5cm



Shown with Optional Support Base\*

### Model 75X (41 qt/39 liter)

**Model 75X-120:** 120 Volt, 50/60 Hz 1650 watts/13.75 amps

**Model 75X-240:** 240 Volt, 50/60 Hz 1650 watts/6.88 amps

<b>Gross Capacity</b>	<b>41 qt/39 liter</b>
Overall Height	19"/48.3cm
Bottom Height	14 <sup>1</sup> / <sub>4</sub> "/36.2cm
Inside Diameter	15 <sup>1</sup> / <sub>4</sub> "/38.7cm
Unit Weight	45 lbs./20.4kg

#### Inner Container No. 4156

Height	10 <sup>1</sup> / <sub>4</sub> "/26cm
Diameter	14"/35.6cm
Circumference	44 <sup>7</sup> / <sub>8</sub> "/113cm
Capacity	27.3 qt/25.8 liter
Volume	1578in <sup>3</sup> /25,856cm <sup>3</sup>

Carton Dimensions 24" x 24" x 21"  
61cm x 61cm x 53.3cm

Shipping Weight 51 lb./23.1kg

Unit Pack: 1 Cube: 7

#### Optional No. 4180 Support Base

Height	3 <sup>7</sup> / <sub>8</sub> cm high
Outside Diameter	16 <sup>1</sup> / <sub>4</sub> "/41.3cm
Inside Diameter	15"/38.1cm
Elevates Sterilizer Above Surface	2 <sup>1</sup> / <sub>4</sub> "/5.7cm

## ADDITIONAL ELECTRIC MODEL



Shown with Optional Support Base\*

### Model 25X (25 qt/24 liter)

**Model 25X-120:** 120 Volt, 50/60 Hz 1050 watts/8.75 amps

**Model 25X-240:** 240 Volt, 50/60 Hz 1050 watts/4.38 amps

<b>Gross Capacity</b>	<b>25 qt / 24 liter</b>
Overall Height	16 <sup>3</sup> / <sub>4</sub> " / 42.5cm
Bottom Height	12 <sup>1</sup> / <sub>4</sub> " / 31.2cm
Inside Diameter	12 <sup>5</sup> / <sub>8</sub> " / 32.1cm
Unit Weight	26 lbs. / 11.8kg

#### Inner Container No. 2156

Height	8 <sup>1</sup> / <sub>2</sub> " / 21.6cm
Diameter	11 <sup>1</sup> / <sub>8</sub> " / 28.3cm
Circumference	35 <sup>7</sup> / <sub>8</sub> " / 91.1cm
Capacity	14.5 qt / 13.7 liter
Volume	835in <sup>3</sup> / 13,688cm <sup>3</sup>

Carton Dimensions 21" x 17<sup>1</sup>/<sub>2</sub>" x 18<sup>1</sup>/<sub>2</sub>"  
53.4cm x 44.5cm x 47cm

Shipping Weight 30 lb. / 13.6kg

Unit Pack: 1 Cube: 3.75

#### Optional No. 2180 Support Base

Height	2" / 5cm high
Outside Diameter	12 <sup>3</sup> / <sub>4</sub> " / 32.4cm
Inside Diameter	12 <sup>3</sup> / <sub>8</sub> " / 31.4cm
Elevates Sterilizer Above Surface	1 <sup>3</sup> / <sub>8</sub> " / 3.5cm

## NON-ELECTRIC MODELS ARE ALSO AVAILABLE IN THREE SIZES:



### Model 1915X (15 qt/14 liter)

<b>Gross Capacity</b>	<b>15 qt/14 liter</b>
Overall Height	12 <sup>1</sup> / <sub>4</sub> "/31.2cm
Bottom Height	7 <sup>3</sup> / <sub>4</sub> "/19.7cm
Inside Diameter	12 <sup>5</sup> / <sub>8</sub> "/32.1cm
Unit Weight	15 lbs./6.8 kg

#### Inner Container No. 2163

Inside Depth	5 <sup>3</sup> / <sub>4</sub> "/14.6cm
Inside Diameter	11 <sup>1</sup> / <sub>8</sub> "/28.3cm
Circumference	35 <sup>7</sup> / <sub>8</sub> "/91.1cm
Capacity	9.5 qt/9 liter
Volume	550in <sup>3</sup> /9029cm <sup>3</sup>

Carton Dimensions 15<sup>1</sup>/<sub>2</sub>" x 14<sup>1</sup>/<sub>2</sub>" x 13<sup>1</sup>/<sub>2</sub>"  
39.4cm x 36.8cm x 34.3cm

Shipping Weight 21 lb./9.52kg

Unit Pack: 1 Cube: 1.76



### Model 1925X (25 qt/24 liter)

<b>Gross Capacity</b>	<b>25 qt/24 liter</b>
Overall Height	16 <sup>3</sup> / <sub>4</sub> "/42.5cm
Bottom Height	12 <sup>1</sup> / <sub>4</sub> "/31.2cm
Inside Diameter	12 <sup>5</sup> / <sub>8</sub> "/32.1cm
Unit Weight	18 <sup>1</sup> / <sub>4</sub> lbs./8.3kg

#### Inner Container No. 2162

Inside Depth	10 <sup>1</sup> / <sub>4</sub> "/26cm
Inside Diameter	11 <sup>1</sup> / <sub>8</sub> "/28.3cm
Circumference	35 <sup>7</sup> / <sub>8</sub> "/91.1cm
Capacity	17.6 qt/16.6 liter
Volume	1016in <sup>3</sup> /16,655cm <sup>3</sup>

Carton Dimensions 15<sup>1</sup>/<sub>2</sub>" x 14<sup>1</sup>/<sub>2</sub>" x 18<sup>1</sup>/<sub>2</sub>"  
39.4cm x 36.8cm x 47cm

Shipping Weight 25 lb./11.33kg

Unit Pack: 1 Cube: 2.41



### Model 1941X (41 qt/39 liter)

<b>Gross Capacity</b>	<b>41 qt/39 liter</b>
Overall Height	19"/48.3cm
Bottom Height	14 <sup>1</sup> / <sub>4</sub> "/36.2cm
Inside Diameter	15 <sup>1</sup> / <sub>4</sub> "/38.7cm
Unit Weight	33 lbs./15kg

#### Inner Container No. 2164

Inside Depth	10 <sup>1</sup> / <sub>2</sub> "/26.7cm
Inside Diameter	14"/35.6cm
Circumference	44 <sup>7</sup> / <sub>8</sub> "/113cm
Capacity	27.9 qt/26.4 liter
Volume	1613in <sup>3</sup> /26,451cm <sup>3</sup>

Carton Dimensions 19" x 19" x 20<sup>1</sup>/<sub>2</sub>"  
48.3cm x 48.3cm x 52.1cm

Shipping Weight 41 lb./18.6kg

Unit Pack: 1 Cube: 4.28

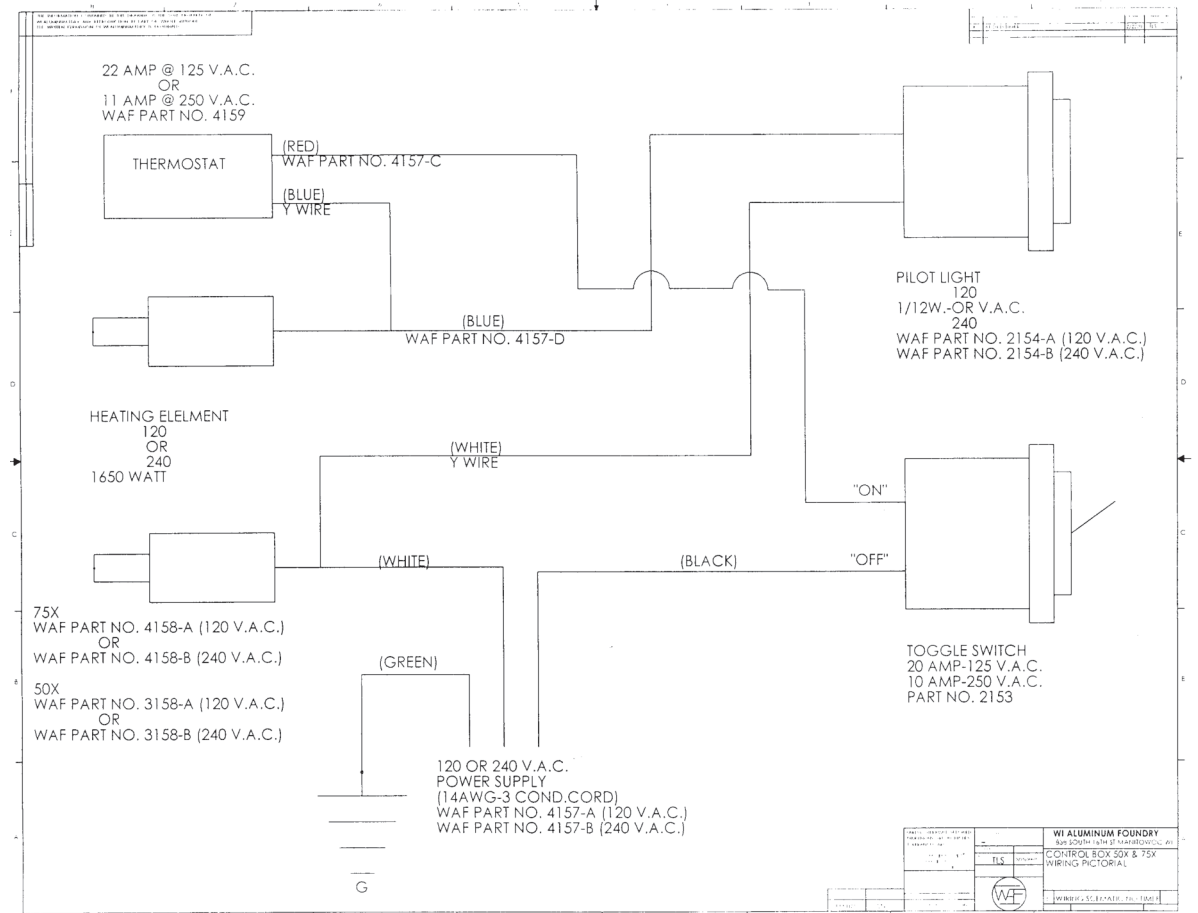
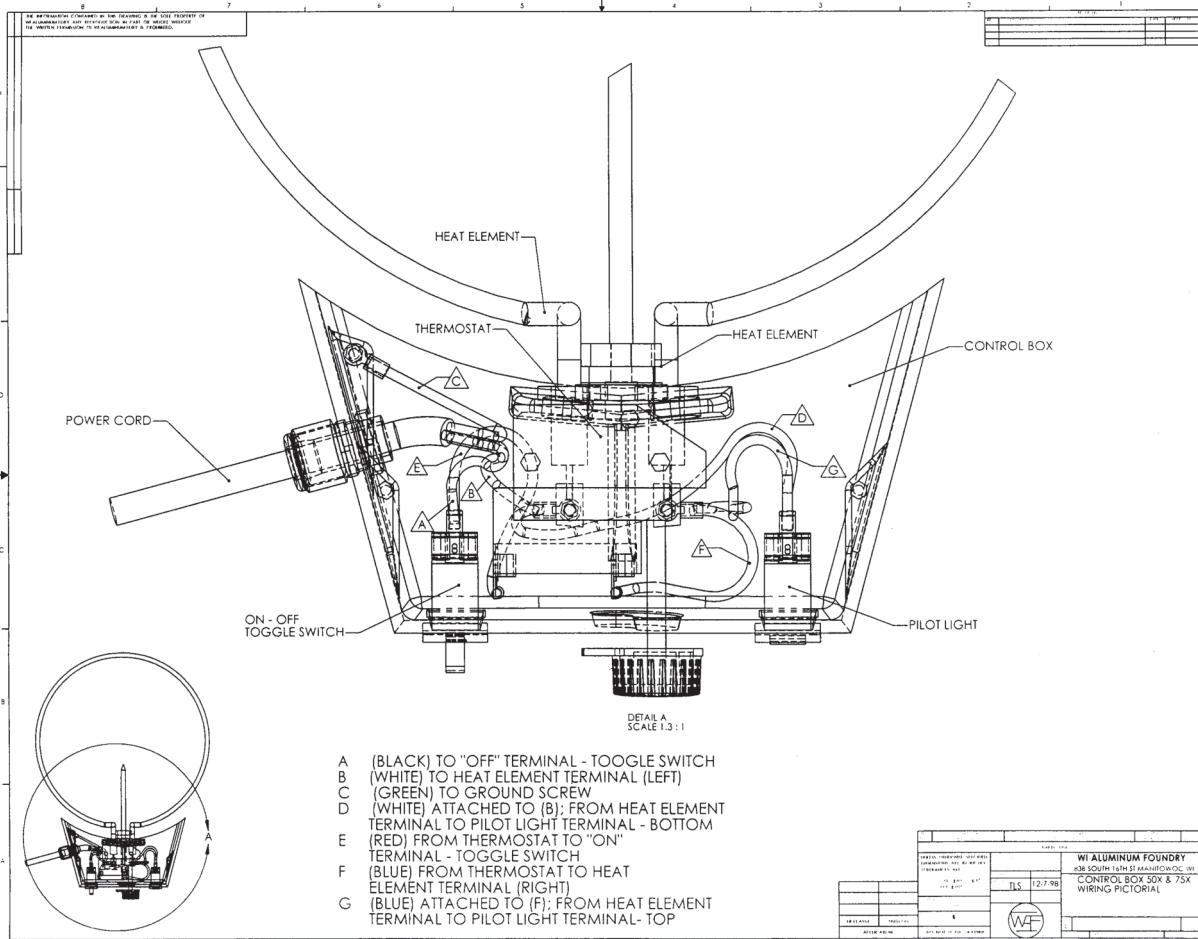



# ALL-AMERICAN 50X/75X PRESSURE STEAM STERILIZERS PARTS LIST

Part No.	Description
	Bottom only (specify size and with or without parts)
	Cover only (specify size and with or without parts)
54	Clamp Bolt (630000) (3/8"=16 x 1 25/32")
55	Pin for Clamp Bolt (630010)
64	Wing Nut (630020)
<b>65</b>	<b>DISCONTINUED — Replaced by # 65K</b>
<b>65K</b>	<b>Tested Control Valve (releases at 23-28 psi) (Z000207) (1/8"NPT) Replaces #65</b>
72S	Tested Steam Gauge - includes lens (Z000128) (1/8" NPT)
<b>75</b>	<b>(Replaced by No. 2050CS) Excess Pressure Release Plug (not shown)</b>
<b>76</b>	<b>Bakelite Top Handle (No Longer Available) ** Order Part Number 76-09 RM **</b>
76-09 RM	Handle w/Screws (New Handle to Replace Old Style #76 with Screws - See Picture) Z000198
76-09	Handle w/Screws (New Style Handle-See Picture) Z000187
77-09	Top Handle Screw (New Style only) (630077)
78	Retaining Bayonet Clamp (630090)
79	Bayonet Clamp Screw (670020)
111	Rack (For inside Aluminum Container for 1915X, 1925X, 25X & 50X (630110) (9 1/2" Diameter)
151	Side Handle Complete (with screws, for 1941X & 75X) (Z000113)
405	Side Handle Complete (with screws, for 1941X & 75X) (Z000113)
1010	Overpressure Plug (For Sterilizer - Red Color) (Z000123)
2050 CS	Pressure Relief Valve (releases as 26 psi) (640180) (1/8"NPT)
2151	Stnls Steel Support Stand (used inside 25X & 50X) (640010)
2153	On/Off Toggle Switch (25X, 50X & 75X) (640020)
2154A 120V	Pilot Light 110-120 Volt (25X, 50X & 75X) (640190)
2154B 240V	Pilot Light 220-240 Volt (25X, 50X & 75X) (640200)
2155-15	Ex Tube 1915X (640210) (7 1/4 inches long)
2155-25	Ex Tube 1925X/25X/50X (640220) (10 3/4 - 11 inches long)
2155-41	Ex Tube 1941X/75X (640230) (14 3/4 inches long)
2156	Alum Container 25X/50X (640030)
2157	Detachable Cord and Plug (25X (for models made before 1980) Eff. 4/04 - (640040)
2157A 120V	3 Wire Harness 120V (Power Supply Cord for 25X-120V) (640240)
2157B 240V	3 Wire Harness 240V (Power Supply Cord for 25X-240V) (640250)
2157 SRB	Strain Relief Bushing (for Power Cord into Control Box for 25X - units made before 2003) (640260)
*2158 AS 120V 120V 1050W Heat Element (for 25X includes fiber gaskets) (640280)	
*2158 BS 240V 240V 1050W Heat Element (for 25X includes fiber gaskets) (640290)	
	*Factory Installation Fee for Heating Element
2158 FG	Fiber Gasket Heat Elmnt (2158, 3158 & 4158 Heating Element (two needed) (640300)
*2159	Thermostat for 25X (includes fiber gasket) (Z000130)
2159 FG	Gasket for Thermostat (Fiber Gasket -2159 Thermostat & 4159 Thermoswitch (1 needed) (640310)
2160	Heat Cntrl Knob-Thermstat (25X) (640060)
2161A (120V)	Control Box W/D Plate (25X-120V Z000129)
2161 B (240V)	Ctrl Bx W/D Plate (25X-240V Z000139)
2162	Alum Container 1925X (640070)
2163	Alum Container 1915X (640080)
2164	Alum Container 1941X (640090)
2180	Support Base for 25X/50X (will elevate unit 1 3/8" above table surface) (2180)
*3158 A 120V 120V 1650W Heating Elmnt (50X includes fiber gaskets) (640410)	
*3158 B 240V 240V 1650W Heating Elmnt (50X includes fiber gaskets) (640420))	
	*Factory Installation Fee for Heating Element
	Fiber Gasket for #3158-A or # 3158-B (See Part # 2158FG)
3161A (120V)	ControlBox W/D Plate (50X-120V) (Z000203)
3161 B (240V)	ControlBox W/D Plate (50X-240V) (Z000204)
4151	Stnls Steel Support Stand (used inside 75X) (640100)
4156	Alum Container 75X (640110)
4157 A 120V	120V 3Wire Wirng Harness (Grounded Power Supply Cord for 50X/75X) (640430)
4157B 240V	240V 3Wire Wirng Harness (Grounded Power Supply Cord for 50X/75X) (640440)
4157C	Red Wire Lead (Single for 50X & 75X) (640450)
4157 D	Blue Wire Jumper Lead ("Y" for 50X & 75X ) (640460)
4157 SRB	Strn Relief Bshng (Metal - Power Supply Cord into control box for 25X**, 50X & 75X (** for Model 25X units made after 12/31/02 only) (See Part #2157SRB also) (Z000135)
*4158 A 120V	120V 1650W Heat Element (Heating Element-75X-120V)(includes fiber gaskets) (640510)
*4158 B 240V	240V 1650W Heating Element (Heating Element-75X-240V) (includes fiber gaskets) (640520)
	*Factory Installation Fee for Heating Element
	Fiber Gasket for # 4158-A or # 4158-B (See Part # 2158FG)
*4159	Thermoswitch (50X/75X) (includes fiber gasket and thermowell) (Z000136)
	*Factory Installation Fee For Thermoswitch
4160	Control Knob Thermostat (Thermoswitch for 50X/75X (640130)
4161A (120V)	ControlBox W/D Plate (75X-120V) (Z000205)
4161B (240V)	ControlBox W/D Plate (75X-240V) (Z000206)
4180	Support Base for 75X (will elevate unit 2 1/4" above table surface) (4180)
4190	Timer for 50X/75X (640700)
4190 K	Knob for Timer 50X/75X (640710)
*6054	Dual Scale Thermometer (C Scale: 10 -150 , F Scale: 50 -300) (640140)
	*Factory Installation Fee for Thermometer
* We Recommend that the Thermostat, Thermoswitch, Heating Element, and Thermometer be replaced at the Factory.	
<b>NO GUARANTEE OR RESPONSIBILITY FOR THE PROPER FUNCTIONING OF THESE PARTS CANNOT BE ASSUMED BY COMPANY IF THEY ARE NOT INSTALLED AT THE FACTORY.</b>	

## ALL-AMERICAN PRESSURE STEAM STERILIZER LIMITED WARRANTY

This quality sterilizer is designed and manufactured to provide many years of satisfactory performance under normal use. Wisconsin Aluminum Foundry pledges to the original owner that should there be any defects in material or workmanship during the first year after purchase, we will repair or replace it at our option. This pledge does not apply to damage caused by shipping. To obtain service under the warranty:

1. A Return Authorization (RA) Number is required by our company to return any product manufactured by Wisconsin Aluminum Foundry. Merchandise returned without an RA Number will be refused. To obtain an RA Number contact our company by either writing, faxing or calling our Customer Service Department at 920-682-8627. All defective merchandise must be returned to our factory before credit or a replacement will be issued; do not destroy the defective merchandise. Any products returned must include paperwork stating the reason for the return, when and where the item(s) were purchased, model numbers, quantities, etc., and who to contact with any questions. Prior to return to the factory, all sterilizers **must** be cleaned to remove any biological material or contaminants.
2. Return sterilizer, shipping prepaid, direct to:  
Wisconsin Aluminum Foundry Co., Inc.  
Consumer Products Division  
1931 South 14th Street  
Manitowoc, WI 54220

### IMPORTANT — PLEASE READ

Any alterations, modifications or changes of any type made to the sterilizer or to any component thereof will void this warranty!

We want you to obtain maximum performance from using this quality sterilizer and we ask that you take the time to read and follow the operating instructions. Failure to follow instructions, damage caused by improper replacement parts, abuse, or misuse will void this pledge. This warranty gives you specific legal rights, and you may also have other rights which vary from state to state. This is Wisconsin Aluminum Foundry's personal pledge to you and is being made in place of all other express warranties.

### RETURN/SERVICE

Should the pressure sterilizer ever be dropped, the unit must be examined to determine if any damage has occurred. We recommend the unit be returned to our factory to be thoroughly checked inside and out for any damage. Prior to return to the factory, all sterilizers **must** be cleaned to remove any biological material or contaminants. We will examine the entire unit, including the control valve and gauge, and determine if the unit has sustained damage, and notify you of our findings.

A Return Authorization (RA) Number is required by our company to return any product manufactured by Wisconsin Aluminum Foundry. Merchandise returned without an RA Number will be refused. To obtain an RA Number contact our company by either writing, faxing or calling our Customer Service Department at 920-682-8627. All defective merchandise must be returned to our factory before credit or a replacement will be issued; do not destroy the defective merchandise. Any products returned must include paperwork stating the reason for the return, when and where the item(s) were purchased, model numbers, quantities, etc., and who to contact with any questions. If the product is found to be defective, we will either send a replacement or issue full credit, and we will reimburse you for the return shipping charges. If product is not defective, we will contact you with repair charges, or issue credit, less our 20% restocking fee.

Should you have any questions at all about the operation of your ALL-AMERICAN Pressure Sterilizer, please write the Consumer Products Division, and we will promptly answer your questions.

To order any replacement parts, please refer to the parts price list. If you do not have a copy of our current parts price list, you may write the company and one will be forwarded to you by return mail.

## WISCONSIN ALUMINUM FOUNDRY CO., INC.

### CORRESPONDENCE:

WISCONSIN ALUMINUM FOUNDRY CO., INC.  
P.O. BOX 246  
MANITOWOC, WISCONSIN 54221-0246  
PHONE: (920) 682-8627 / FAX: (920) 682-4090  
email: [customerrelations@wafco.com](mailto:customerrelations@wafco.com)  
website: [allamerican-chefsdesign.com](http://allamerican-chefsdesign.com)  
or shortcut: [aa-cd.co](http://aa-cd.co)

### RETURN & SERVICE:

WISCONSIN ALUMINUM FOUNDRY CO., INC.  
CONSUMER PRODUCTS DIVISION  
1931 SOUTH 14TH STREET  
MANITOWOC, WI 54220



# **ALL AMERICAN** **PRESSURE STEAM STERILIZERS**

This Wisconsin Aluminum Foundry product is warranted against defects in workmanship or material for a period of (1) YEAR from date of original purchase. If the product becomes defective within the warranty period, Wisconsin Aluminum Foundry will repair or replace it at our discretion. This warranty gives you specific legal rights, you may also have other rights which vary from state to state. This warranty does not cover damage to the products resulting from misuse, overheating, accidents or alterations to the product.

A Return Authorization Number is required by our company to return any product manufactured by Wisconsin Aluminum Foundry. To do so, you will need to contact our company by either writing, calling or faxing; however, with any products returned to Wisconsin Aluminum Foundry, you must include paperwork stating the reason for the return and who we can contact with any questions. We need to know when and where the item(s) were purchased, model numbers, quantities, etc. Please contact our Customer Service Department at (920) 682-8627 for a Return Authorization (RA) Number. Merchandise returned without a Return Authorization Number will be refused. All defective merchandise must be returned to our factory before credit or a replacement will be issued. Do not destroy the merchandise. Return the product postage prepaid to:

Wisconsin Aluminum Foundry Co., Inc.  
Consumer Products Division  
1931 South 14th Street  
Manitowoc, WI 54220  
Phone (920) 682-8627  
Fax (920) 682-4090

You must enclose your return address, sales receipt and a brief description explaining the claimed defect. If the product is determined to be defective, Wisconsin Aluminum Foundry will repair or replace your cookware free of charge.

**IMPORTANT:** Complete and mail the warranty registration card immediately.



AFFIX FIRST  
CLASS POSTAGE  
HERE  
Post Office  
Will Not Deliver  
Without Postage

Wisconsin Aluminum Foundry Co., Inc.  
Consumer Products Division  
P.O. Box 246  
Manitowoc, WI 54221-0246



# ALL AMERICAN PRESSURE STEAM STERILIZERS

## IF YOU NEED TO SHIP THE PRODUCT

The product must be sent carefully packed (the item must be properly cushioned) to prevent damage in transit and should be adequately insured. Failure to abide by these provisions may cause your request for warranty service to be denied.

Please attach your name, address, telephone number, a description of the problem and a copy of the original sales receipt bearing the appropriate model number as proof of retail purchase for each product returned for warranty service.

We never sell or rent your personal information to any third parties under any circumstances.

## FOR YOUR PROTECTION

Complete and mail the attached WARRANTY REGISTRATION CARD immediately so that we may contact you directly in the event a safety notification is issued in accordance with the 1972 Consumer Product Safety Act, or for other reasons.

## IMPORTANT INFORMATION FOR YOUR RECORDS

MODEL NO.

SIZE

DEALER NAME

DEALER ADDRESS

CITY

STATE

ZIP CODE

DATE OF PURCHASE



WARRANTY REGISTRATION

PLEASE PRINT

DATE OF PURCHASE

MODEL NUMBER

LAST NAME

FIRST NAME

STREET ADDRESS

CITY

STATE

ZIP

DEALER NAME

DEALER ADDRESS

COMMENTS

PLEASE COMPLETE AND MAIL THIS WARRANTY REGISTRATION CARD IMMEDIATELY TO PROTECT YOUR WARRANTY SERVICE. FILL OUT CARD USING BLACK INK ONLY.