

Cartridge Machine

USER MANUAL



INDEX

Safety Notice	3
Machine Overview	4
The Grip	5
The Body	6
The PowerBolt	7
The RCA Module	8
Switching Power Options	9
Charging Your Machine	10
Adjusting Needle Depth	11
eGive with RCA Module	12
eGive with PowerBolt	13
Additional Information	14
Troubleshooting	15



SAFETY NOTICE



CLASS III SYMBOL

A Class III appliance is designed to be supplied from a separated/safety extra-low voltage (SELV) power source. The voltage from a SELV supply is low enough that under normal conditions a person can safely come into contact with it without risk of electrical shock. The extra safety features built into Class I and Class II appliances are, therefore not required. For medical devices, compliance with Class III is not considered sufficient protection, and more stringent regulations apply to such equipment.

TECHNICAL DATA	
Operating Voltage:	5 - 12 V DC
Current:	1 A
Stitch Frequency:	25 - 160 Hz
Stroke:	2.5, 3.2 or 4 mm
Connection:	USB-C
Drive:	Brushless 9-watt motor
Operating Mode:	Continuous operation
Ambient Temperature:	+10 to +35° C
Relative Humidity:	30 to 75%
Dimensions (Ø X L):	35 x 125 mm
Weight:	Approx. 189 g



BARRIER PROTECTING YOUR MACHINE

Although the grip is autoclavable, we strongly suggest the use of barrier products to protect your machine. For a visual demonstration of many barrier protection methods, please visit FK Irons' YouTube channel.

This device is only for use by trained tattoo artists and not for the use by children or persons of reduced physical, sensory or mental capabilities.



MACHINE OVERVIEW



Traditional RCA power module

Dynamic power path management USB-C Li-ion battery with capacity and voltage LED indicator

USB-C connectivity

Bluetooth-enabled: Pair with Darklab app



Interchangeable battery or RCA module: instantly switch from cable to wireless



9-watt brushless motor

Ratcheted, adjustable needle depth system

Direct Drive: 3 stroke options available



THE EXO Unstoppable

FK Irons' first modular tattoo machine, offering the freedom to choose your power source: use a traditional RCA cable or the wireless, Bluetooth-enabled PowerBolt. Ready for anything. Simply unstoppable.



Ergonomic autoclavable 40 mm grip weight-forward design for tattooing



Black Ops



Stealth



THE GRIP

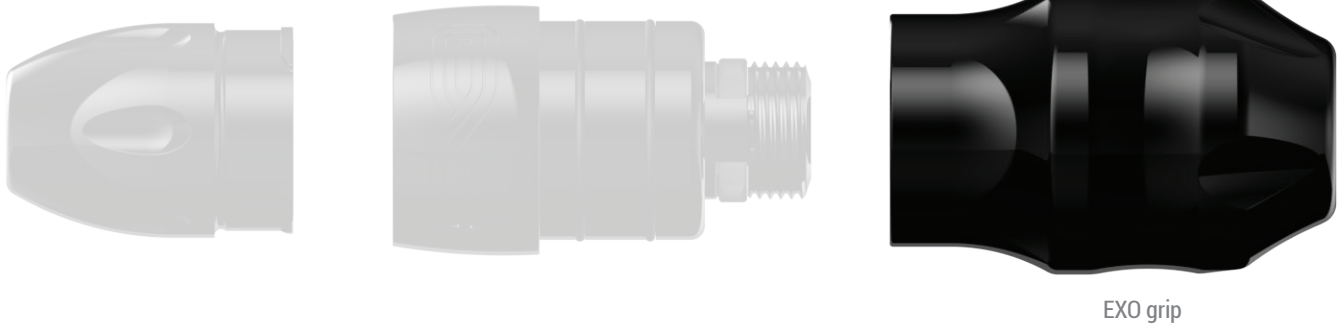

EXO grip



Autoclavable ergonomic grip design

Compatible with most membrane needle cartridges on the market

THE GRIP

The EXO grip allows artists ratcheting control over needle depth. The standard grip has a diameter of 40 mm. Other grip

options will be available soon. The grip is crafted from a solid rod of 6061 T6 aircraft-grade aluminum. This polished and

anodized grip is safe to be sterilized under steam, in an autoclave or wiped down with cold sanitation solutions.



THE BODY



EXO body



THE BODY

The Body is the core of the machine. Constructed from a solid rod of 6061 T6 aircraft-grade aluminum, this module should only be sanitized by wiping it with cold sterilization solutions.

Caution: Avoid getting fluids into the housing



Body isometric view



Body posterior view



THE POWERBOLT

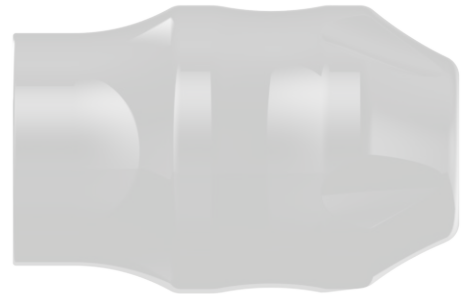
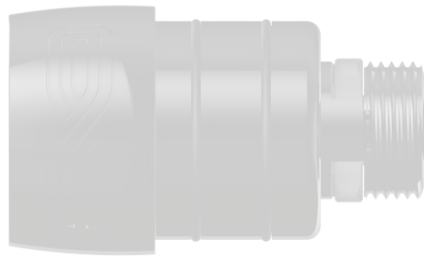

PowerBolt

THE POWERBOLT

LED indicator:

Solid Color = Whole Value

Blinking Color = Half Increment

Ex. Solid green indicates 10V

Flashing green indicates 10.5V

Battery level check: Press and hold power button until white. A blinking colored light indicates remaining charge.

Note: LED flashes while battery charges. Once < 15% is reached, red light will blink alternately with voltage.

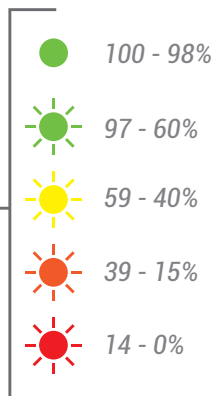

Working with modes: Modes work by pressing and releasing the power button.

Bluetooth – Hold the power button until a blue light appears and immediately release the power button. A blue blinking light indicates pairing mode is available for 60 seconds. To deactivate Bluetooth, hold the power button and release when the yellow light flashes.

Travel Mode (hard shutoff) – Press and hold the power button until the red light flashes. Use this mode to avoid unnecessary discharge and/or comply with travel laws. To reactivate, connect / disconnect to a USB-C port.

Reset (factory settings) – Should you experience abnormal behavior, hold the power button and the voltage down button at the same time, then quickly release.



PowerBolt top/ bottom views

Device reset: +



THE RCA MODULE



RCA module

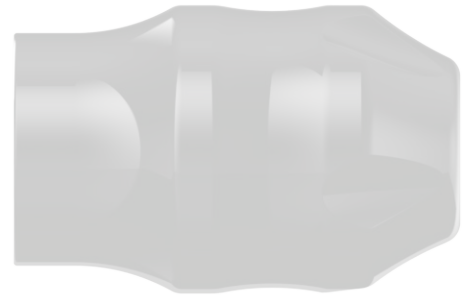
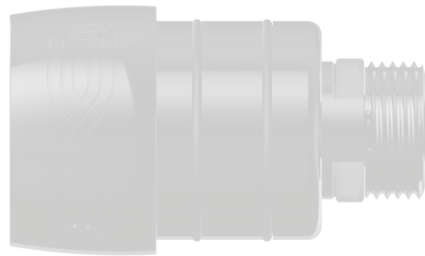

RCA cable plug



RCA motor contact board

DETACHABLE RCA MODULE

The EXO's outstanding feature is that the power module is detachable. Rapidly switch from the RCA module to the

PowerBolt battery pack with a simple quarter-turn action. (instructions on next page)
No matter the circumstances,

the EXO is unstoppable, therefore, you are unstoppable.



POWER OPTIONS

Hold firmly and twist the body as shown.

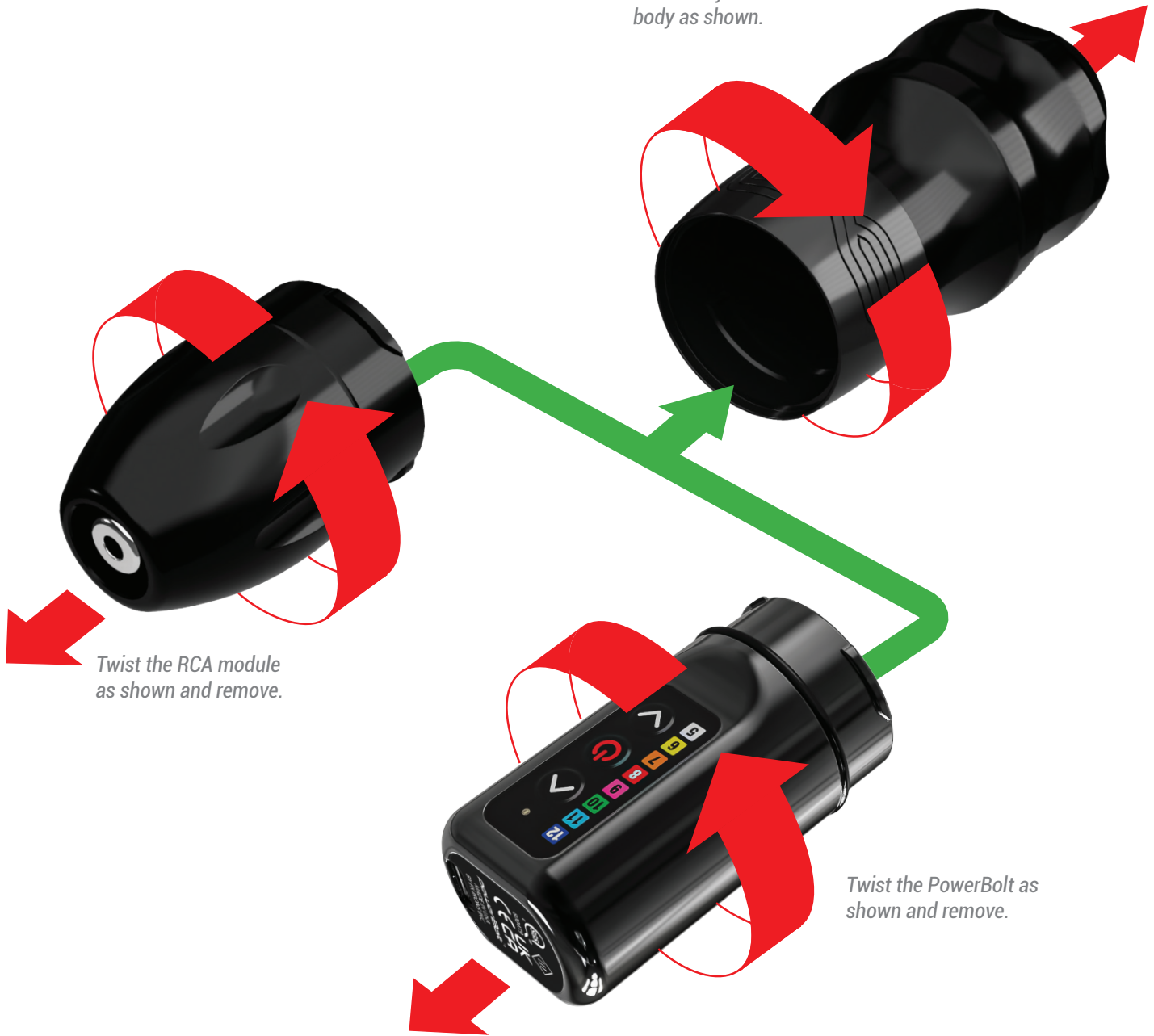

Twist the RCA module as shown and remove.

Twist the PowerBolt as shown and remove.

SWITCHING POWER OPTIONS

To detach your PowerBolt or RCA module, ensure you have a firm grip on the body and grip. Turn the PowerBolt/RCA module counterclockwise

and pull apart. To attach the PowerBolt/RCA module, push in while twisting clockwise. Ensure lock mechanism moves freely. PowerBolt/RCA module

must be flush to ensure power leads align correctly. Avoid contact with the leads on either module while recharging or servicing.



CONNECTING YOUR MACHINE



USB-C connector
Fast charging speed: up to 1.5 A

1 Plug the USB-C cord into the PowerBolt connector.

Correct connection

HOW TO CHARGE YOUR MACHINE

Insert the provided USB-C cable into the back of the PowerBolt and connect to a Hover or power socket. Make sure the cable is properly seated and is fully inserted into PowerBolt. The PowerBolt is not designed to operate

while plugged in. The USB-C connection is intended only for charging your PowerBolt. PowerBolt can be recharged while not attached to the EXO. If connecting to a Hover, the charge speed will be up to 1 A.



ADJUSTING NEEDLE DEPTH

ADJUSTING NEEDLE DEPTH

To adjust needle depth, hold the machine body and PowerBolt while turning the grip. *A counterclockwise turn decreases depth, while a clockwise turn increases depth (also known as needle hang).*

Each time you turn the grip you can feel the tactile feedback of the ratcheting mechanism. Each "click" displaces your needle 0.2 mm and allows you to set your needle precisely without involuntarily turning while tattooing.

Increases needle depth

Decreases needle depth



Turning the grip as shown increases needle depth.



Turning the grip as shown decreases needle depth.



eGIVE WITH RCA MODULE

Currently, controlling eGive via the app is only available by connecting the RCA cable to the Hover power supply. You can control eGive on the PowerBolt itself without the app.

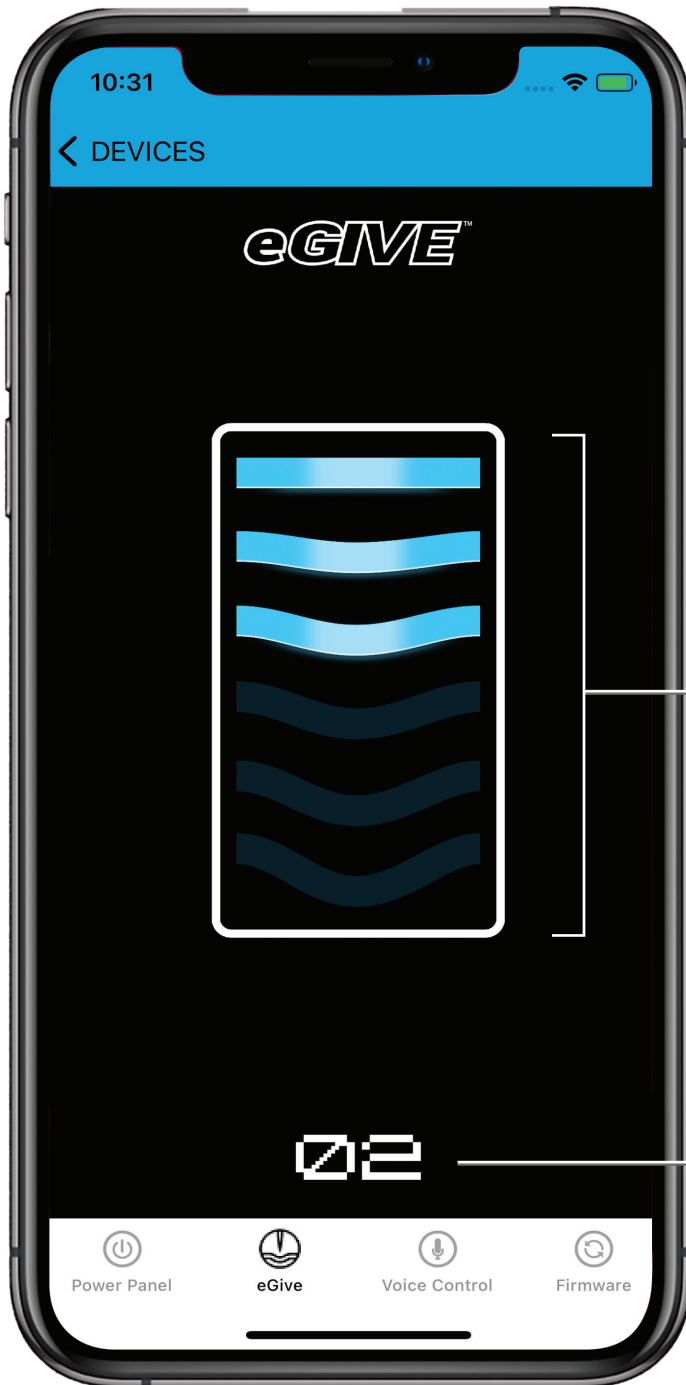

eGIVE ADJUSTMENT

With this feature you'll be able to control the amount of "give," or resistance of the needle upon impact with the skin, even on direct drive tattoo machines. This enables the artist to take advantage of the softness or hardness of hit to achieve specific results. 0 has no effect, 5 offers the maximum amount of eGive.

SETTING eGIVE

There are 6 settings for eGive, 0 through 5. Change the setting by swiping the bars up or down. The higher the setting the higher the amount of give. 0 = no give, 5 = maximum give.

eGIVE INDICATOR

The number displayed is the current eGive setting.



eGIVE WITH POWERBOLT

eGIVE ADJUSTMENT WITH POWERBOLT

When using the EXO with the PowerBolt, the eGive will be controlled on the PowerBolt, not the app. You must update the PowerBolt with the latest Darklab app version to download that feature.



HOW TO CHECK THE CURRENT eGIVE SETTING

- Hold down the power button until the light goes from white to solid blue.
- Release the power button.
- The following blinking color that the LED displays indicates the give that the unit is currently set at. For example:
 - a white blinking light indicates the lowest at 0 (zero)
 - a yellow blinking light indicates level 1 eGive
 - an orange blinking light indicates a softness of 2 eGive
 - a red blinking light indicates a softness of 3 eGive
 - a pink blinking light indicates a softness of 4 eGive
 - a green blinking light indicates a softness of 5 (softest eGive setting)

CHANGING eGIVE

To raise or lower the give:

- Hold down the power button until the light goes from white to solid blue.
- Release the power button and immediately use the up or down arrows to change the give.

The colors should change accordingly.

	 White - eGive of 0
	 Yellow - level 1 eGive
	 Orange - level 2 eGive
	 Red - level 3 eGive
	 Pink - level 4 eGive
	 Green - level 5 eGive (softest setting)



ADDITIONAL INFORMATION

VOLTAGE PARAMETERS

While best voltage is a preference that will vary from artist to artist, this machine has been tested to operate at a minimum of 5 Volts and a maximum of 12 Volts. Depending on the type of needle configuration or brand you use, feel free to adjust the voltage to obtain the desired performance.

ACCEPTED NEEDLES

Use only cartridge needles with an internal membrane. This will avoid accidental contamination inside your machine. Fluids such as ink, water or oil will void warranty of the device and may require replacement of internal parts.

MAINTENANCE

- The EXO is sold pre-lubricated from the factory and does not require internal lubrication.
- Prevent any type of external elements from entering inside the machine as they will disrupt the motion of the component and contaminate the lubricant.
- The grip of the machine is autoclavable. Use only steam autoclaves at temperatures no higher than 270° Fahrenheit or 132.222° Celsius. Add a hint of ointment or PTFE grease around internal opening of grip or on stabilizing friction O-rings for optimal functionality after autoclaving. Refer to page 5 for additional information.
- Machine Body and PowerBolt can be sanitized on the outside with cold sterilization products.
- Never spray the surface directly. Prevent fluids from entering the machine. Use no-lint rags or paper towels.
- ***DO NOT DISASSEMBLE MACHINE.***

WARRANTY

- All the housing components (Grip, Machine Body and PowerBolt) are covered by a lifetime warranty.
- Internal parts are subject to wear and the motor itself is covered by a 1 year warranty from the date of purchase.
- Motor warranty is void if motor shows signs of being dropped, of internal fluids entering the motor and/or IF motor shows signs of being tampered with in any way.



ADDITIONAL INFORMATION

HANDY TIPS

The following tips will help you get the most out of your EXO and avoid potential issues:

- Always secure your machine. Dropping the machine can cause damage to the magnets, bearings and brushes of the motor.
- Use only cartridges with membranes to avoid contamination.
- Rinse your needle frequently to avoid pigment drying up and slowing down your cartridges. When rinsing your needle, ensure to dip only the tip of the cartridge to avoid back flow of fluids.
- Inspect your needles prior to use.
- Avoid scratching any part of the surface.
- Use only FDA-approved cold sterilization solutions for disinfection.
- Do not lubricate machine unless instructed otherwise.
- Store your machine in a secure place.
- Before first use, charge battery for a minimum of 3 hours.

TROUBLESHOOTING

1. Machine manufacturer

FK Irons: 1771 NW 79th Avenue, Doral, Florida 33126

2. Servicing your machine

Just like any mechanical device subject to wear, FK Irons strongly suggests that you service your product at least once a year for a proper diagnosis of all working parts. This ensures the optimal condition of all working parts including internal machine clean up and fresh lubrication. Routine servicing will ensure that your machine remains functioning like the very first day. Service is subject to fees.

3. Warning

Disconnect machine from any power source before making any adjustments.

For service inquiries, please contact service@fkirons.com.

For additional tips and tutorials, please visit [Youtube.com/fkirons](https://www.youtube.com/fkirons)