

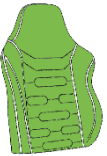

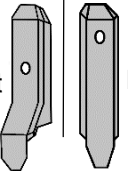

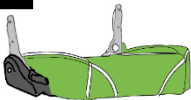





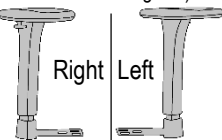

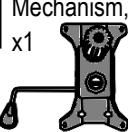

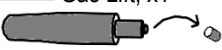
ASSEMBLY INSTRUCTIONS FOR TECHNI SPORT CHAIR MODEL RTA-TSXXL2

PARTS LIST

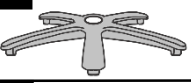
ATTENTION: Before you begin the assembly, make sure that all parts are included in good condition.

A Backrest, x1 	I Bracket Covers Right Left 
B Seat, x1 	J M8x20mm, x10 (Mechanism, armrests) 
C Armrests (Sitting on the chair, Not looking at it) Right Left 	K M8x25mm, x4 (Backrest) 
D Mechanism, x1 	L M5x8mm, x2 (Brackets) 
E Hydraulic Gas Lift, x1 	M O' Rings, x14 
F Covers for Gas Lift, x1 set 	N Washers, x14 
G Star Base, x1 	O Hole covers, x4 
H Caster, x5 	P Allen Wrench, x1 
	Q Lumbar Pillow, x1 

ATTENTION:

- ⚠ Follow the instructions step by step.
- ⚠ To avoid misalignments, leave the screws loose and do not tighten them until all are in their respective places.
- ⚠ Do not overtighten or force the screws as they could break, strip, or damage the threads of the holes.
- ⚠ Using the wrong size of screws on a part could result in damage to the screw or the part.

1 Insert the casters (H) into the legs of the base (G) using pressure.

REMOVE AND DISCARD THE PLASTIC CAP FROM THE TOP OF THE GAS LIFT (E), and place the gas lift in the middle of the base and cover it with (F) as shown.

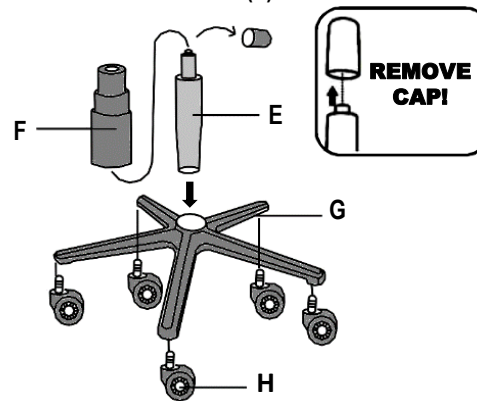

4 Assemble the backrest (A) to the metal brackets on both sides of the seat (B) using screws (K), o' rings (M) and washers (N) as shown.

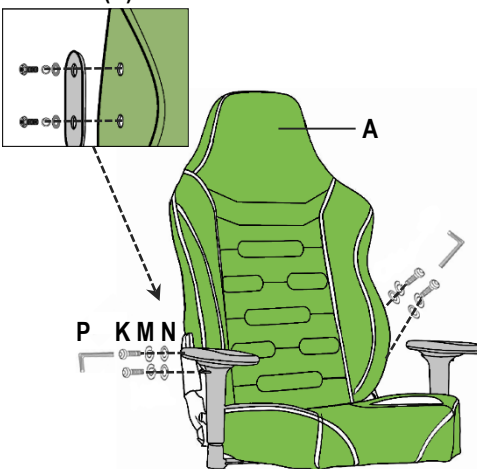

2 Place the seat (B) upside-down with its back end towards you as shown.

Using screws (J), O' rings (M) and washers (N), assemble the mechanism (D) to the seat with its handle facing to your LEFT.

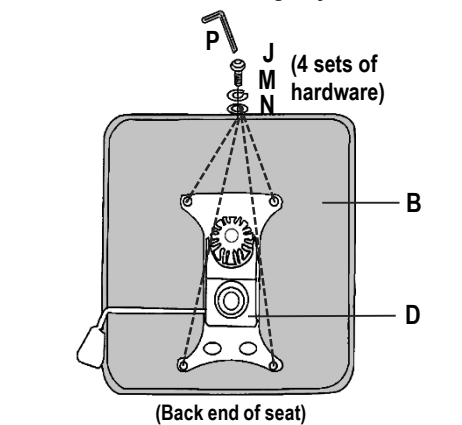

5 Attach the covers (K) to the brackets on their respective sides using screws (L), then cover the holes with (O) as shown.

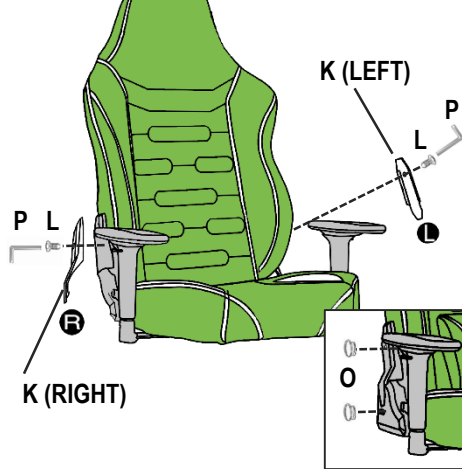

3 Assemble the armrests (C) to the seat (B) on their respective sides using screws (J), O' rings (M) and washers (N).

IMPORTANT: Assemble the arm brackets pushed all the way in!

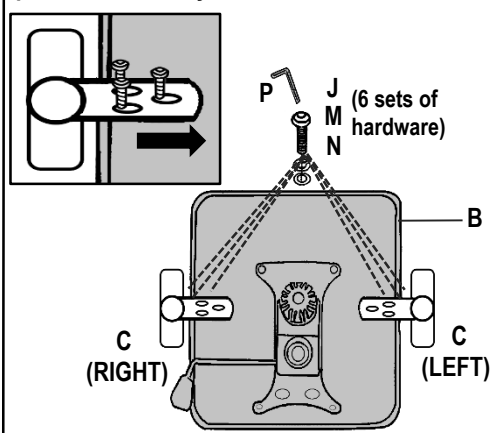

5 Place the seat over the base making sure the tip of the gas lift enters in the hole of the mechanism, and place the lumbar pillow (Q).

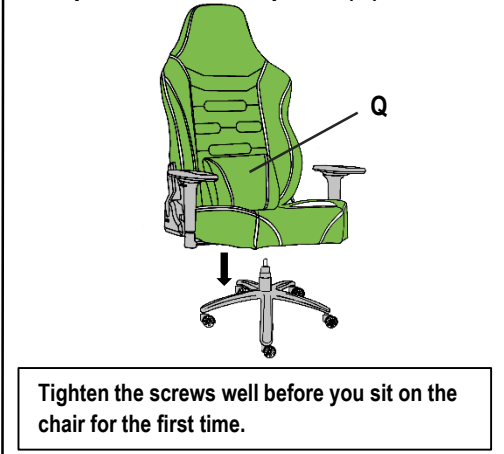

CHAIR'S FUNCTIONS:

- (1) To raise or lower the chair's height, pull UP the lever that is under the seat. The chair goes down while sitting on it, or up if you lift your body.
- (2) To make the chair tilt, pull the same lever OUT horizontally to unlock this function, and IN to lock again.
- (3) To adjust the tension for the tilting function, turn the mechanism's knob in either direction to apply more or less tension.
- (4) To make the backrest recline, pull UP the lever that is located on the rear right side of the seat and release it when the desired position is reached.

WARNING: For your safety, the chair's tilt function (2) in the mechanism should be in the **LOCKED (IN)** position prior to use the backrest reclining function (4).

- (5) To adjust the armrest height, pull UP the button that is under the armrest and release it once the desired height is reached.
- (6) The armrests can also rotate.

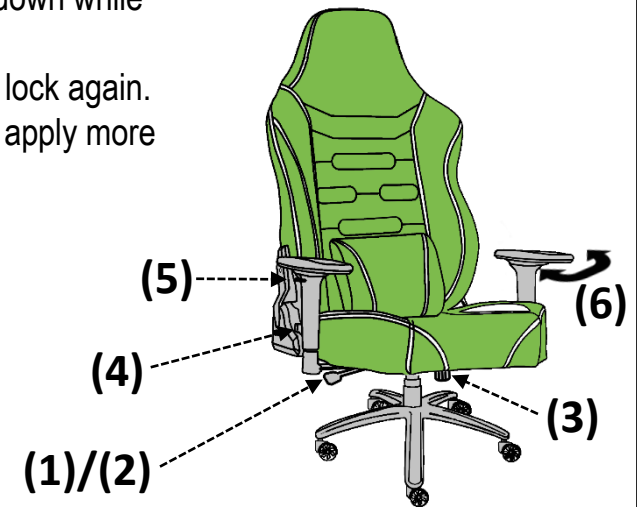

WARNINGS:

- Do not stand up on the chair or use it as ladder.
- Use the chair to seat only one person at a time.
- Do not use the chair if parts are damaged or if screws are loose or missing.
- Do not seat near the edge of the seat and always sit properly on the chair to avoid going beyond your balance point and fall off the chair.
- The chair is intended for teenagers and adults. If small children are using the chair, please keep close observation on them.
- Do not allow small children to play with the chair.
- Not paying attention to these warnings could result in severe injuries.

CARE AND MAINTENANCE:

- To clean the chair it is recommended to use a soft cloth lightly dampened in a solution of smooth soap and water, then dry with a clean towel.
- Do not use solvents or abrasive materials to clean any part of the chair.
- Before applying a cleaning agent, test on a small hidden area of the chair, like underneath the seat.
- Do not expose the product to direct sunlight or to extreme environmental conditions.
- Every 4 months, inspect the chair completely and make sure that all screws are tighten.