









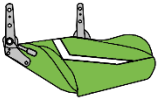
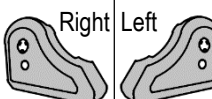
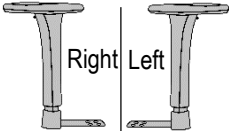
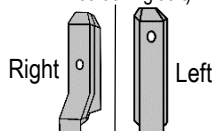
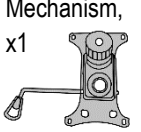

## ASSEMBLY INSTRUCTIONS FOR TECHNI SPORT CHAIR MODEL RTA-TS70

### PARTS LIST

**ATTENTION:** Before you begin the assembly, make sure that all parts are included in good condition.

<b>A</b> Backrest, x1 	<b>I</b> Hole Covers, x4 
<b>B</b> Seat, x1 	<b>J</b> Seat Covers (Sitting on the chair, Not looking at it) 
<b>C</b> Armrests (Sitting on the chair, Not looking at it) Right Left 	<b>K</b> Bracket Covers (Sitting on the chair, Not looking at it) Right Left 
<b>D</b> Mechanism, x1 	<b>L</b> M8x20mm, x16 
<b>E</b> Hydraulic Gas Lift, x1 	<b>M</b> M6x8mm, x4 
<b>F</b> Covers for Gas Lift, x1 set 	<b>N</b> Allen Wrench, x1 
<b>G</b> Star Base, x1 	<b>O</b> Neck Pillow, x1 
<b>H</b> Caster, x5 	<b>P</b> Lumbar Pillow, x1 

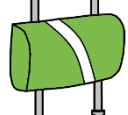
### ATTENTION:

- ⚠ Follow the instructions step by step.
- ⚠ To avoid misalignments, leave the screws loose and do not tighten them until all are in their respective places.
- ⚠ Do not overtighten or force the screws as they could break, strip, or damage the threads of the holes.
- ⚠ Using the wrong size of screws on a part could result in damage to the screw or the part.

**1** Insert the casters (H) into the legs of the base (G) using pressure.  
**REMOVE AND DISCARD THE PLASTIC CAP FROM THE TOP OF THE GAS LIFT (E), and place the gas lift in the middle of the base and cover it with (F) as shown.**

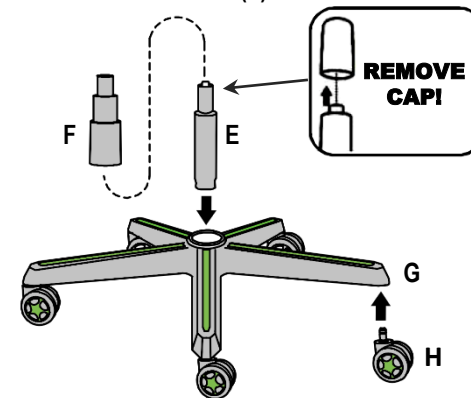

**4** Place the seat over the base making sure the tip of the gas lift enters into the hole of the mechanism. Then assemble the backrest (A) to the seat brackets on both sides using screws (L) as shown.

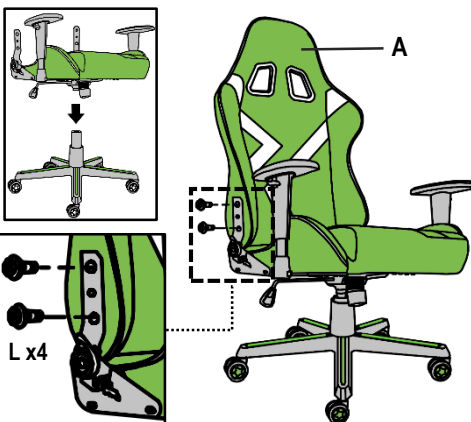

**2** Place the seat (B) upside-down with its back end towards you as shown. Using screws (L), assemble the mechanism (D) to the seat with its handle facing to your LEFT.

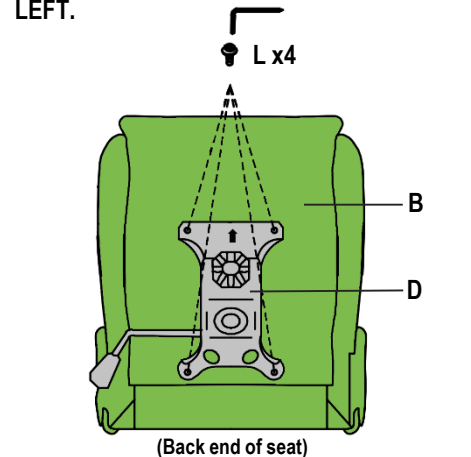

**5** Using screws (M), attach to the brackets on their respective sides, first the covers (J), then the covers (K), and finally cover the holes with (I) as shown.

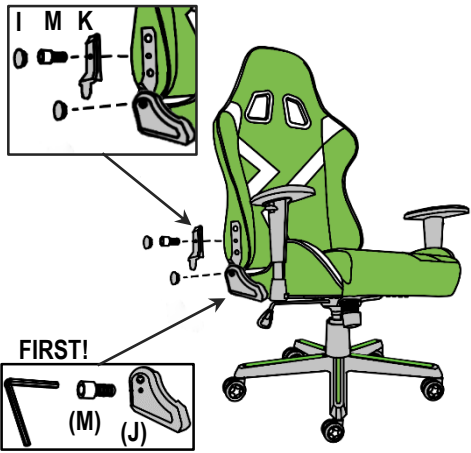

**3** With the seat positioned as shown, assemble the armrests (C) to the seat frame on their respective sides using screws (L) as shown.

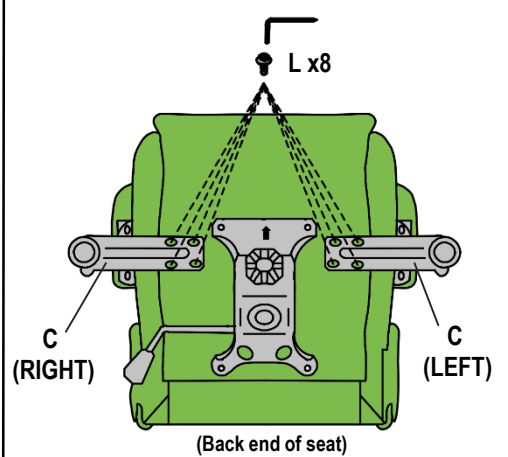

**6** First attach the lumbar pillow (Q), then the neck pillow (P) by fastening the buckles behind the backrest as shown.

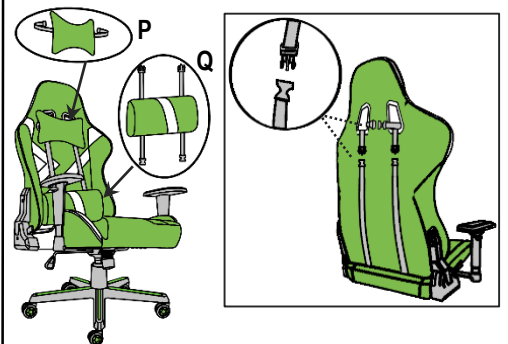

Tighten the screws well before you sit on the chair for the first time.

## CHAIR'S FUNCTIONS:

- (1) Chair height: Pull UP the lever that is under the seat. The chair goes down while sitting on it, or up if you lift your body.
  - (2) Chair tilting: Pull the same lever OUT horizontally to unlock this function. While unlocked, the chair will tilt freely. When the chair is in the normal position, push the lever IN to lock the tilting function.
  - (3) Tilting tension: Turn the mechanism's knob in either direction to apply more or less tension. With less tension, the tilting will feel more easy.
  - (4) Backrest reclining: Pull UP the lever that is located on the rear right side of the seat and release it when the desired position is reached.
- WARNING:** For your safety, the chair's tilt function (2) in the mechanism should be in the **LOCKED** (IN) position prior to use the backrest reclining function.
- (5) To adjust the armrest height, pull UP the button that is under the armrest and release it once the desired height is reached.

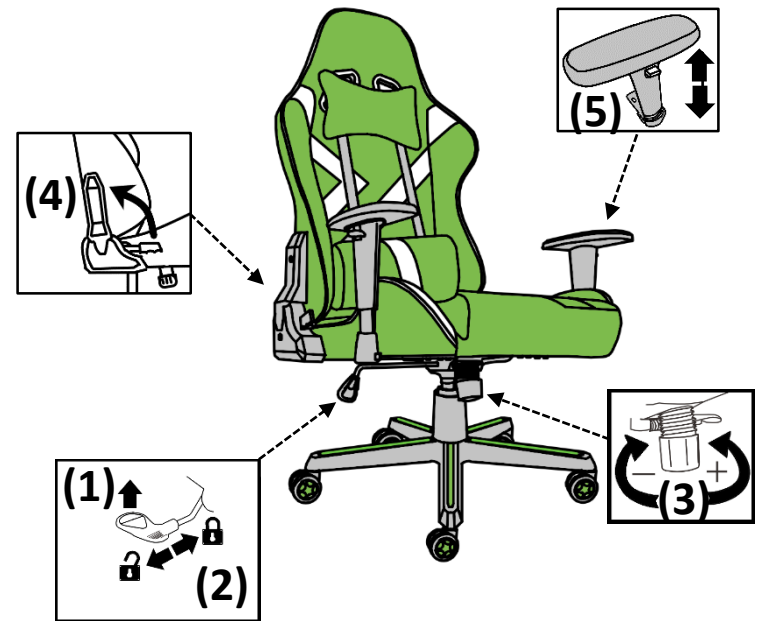

## WARNINGS:

- Do not stand up on the chair or use it as ladder.
- Use the chair to seat only one person at a time.
- Do not use the chair if parts are damaged or if screws are loose or missing.
- Do not seat near the edge of the seat and always sit properly on the chair to avoid going beyond your balance point and fall off the chair.
- The chair is intended for teenagers and adults. If small children are using the chair, please keep close observation on them.
- Do not allow small children to play with the chair.
- Not paying attention to these warnings could result in severe injuries.

## CARE AND MAINTENANCE:

- To clean the chair it is recommended to use a soft cloth lightly damped in a solution of smooth soap and water, then dry with a clean towel.
- Do not use solvents or abrasive materials to clean any part of the chair.
- Before applying a cleaning agent, test on a small hidden area of the chair, like underneath the seat.
- Do not expose the product to direct sunlight or to extreme environmental conditions.
- Every 4 months, inspect the chair completely and make sure that all screws are tighten.