



RSNAV installation manual (HW3.0)

For B8, B8.5 sedan or wagon

Tools required: **Car trim remover, 8mm Hex driver, T20 screw driver, cable ties, and Volkswagen radio removal keys.**

 Do read this manual thoroughly first as there are some situation that you must do or must not do.

 Switch off ignition and all electrical equipment before you begin the installation. Do not switch on the vehicle while any of original AUDI component is detached or disconnected.



Removing and installing cover for MMI screen - up to model year 2011

Removing

- Use removal wedge to prise off cover -1- for MMI screen at corners -arrows- and detach.
- Unplug electrical connector for warning lamp for airbag deactivated on front passenger side / hazard warning lights button and detach cover.



Note

Check retaining clips for damage or deformation and renew if necessary.

- Press on cover for MMI screen until it engages audibly.

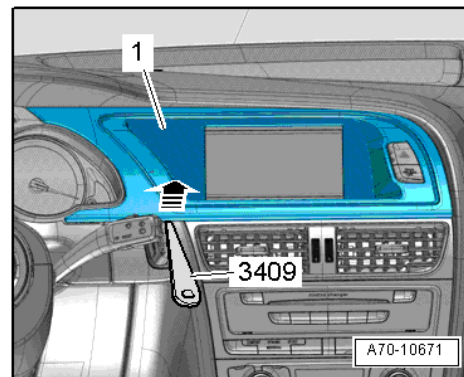

Removing and installing cover for MMI screen - from model year 2012 onwards

Removing

- Move steering wheel down and to rear as far as possible, using full range of steering column adjuster.
- Unclip cover -1- for MMI screen from dash panel at bottom -arrows- using wedge

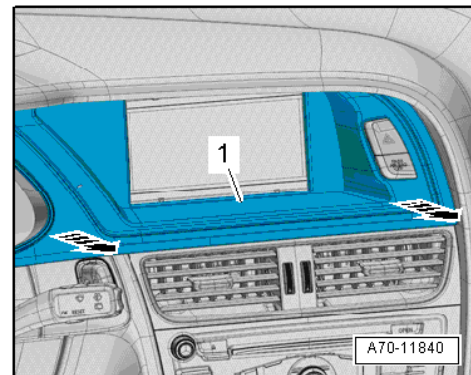

- Carefully unclip cover -1- for MMI screen from instrument cluster at bottom -arrow- using wedge

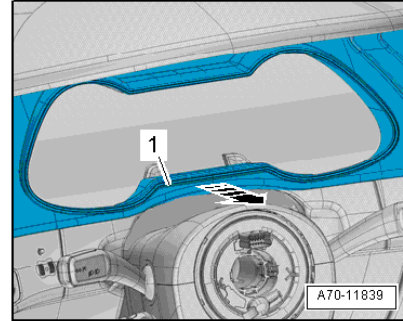

- Unclip cover -1- for MMI screen from dash panel at bottom -arrow B- using wedge.



Note

A hole is provided on both sides of the vent for engaging the hook.

- Carefully insert hook between louvres and engage at side of vent.
- Carefully disengage vent at sides -arrow A-.

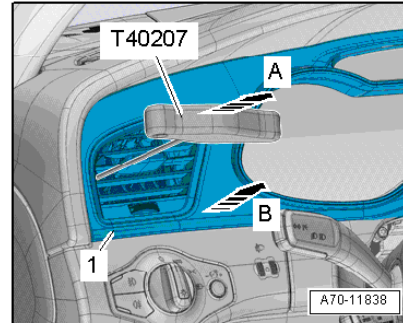

- Carefully unclip cover -1- for MMI screen from dash panel at top -arrows-.
- Unplug electrical connector at dash panel vent.
- Unplug electrical connector for warning lamp for airbag deactivated on front passenger side / hazard warning lights button and detach cover for MMI screen.

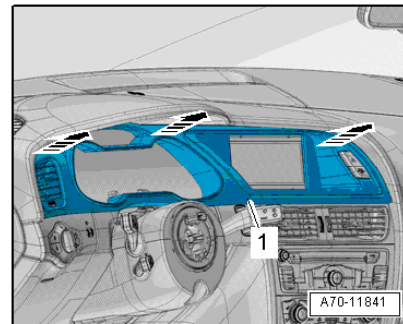

Removing infotainment system display

Display unit for front information display and operating unit control unit (display) is located in dash panel (centre).

Removing

- Remove bolts -arrows- at display unit for front information display and operating unit control unit -1-.
- Lift display unit for front information display and operating unit control unit -1- out of dash panel -2-.
- Release and unplug connectors on display unit for front information display and operating unit control unit.

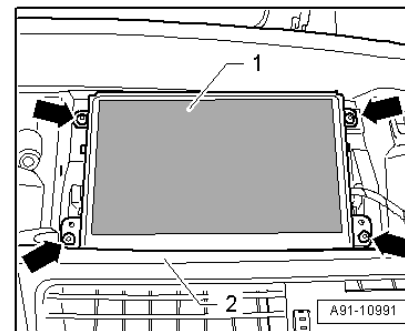

Removing dash panel vent (centre)

Removing



Note

A hole is provided on both sides of dash panel vent for engaging hook.

- Working alternately on each side, carefully pull dash panel vent -1- out of opening using hook.
- Equipment version with light: Unplug electrical connector at dash panel vent.



Note

Check retaining clips for damage or deformation and renew if necessary.

- When inserting dash panel vent in opening, make sure that air duct engages properly.
- Press dash panel vent into installation opening as far as stop.

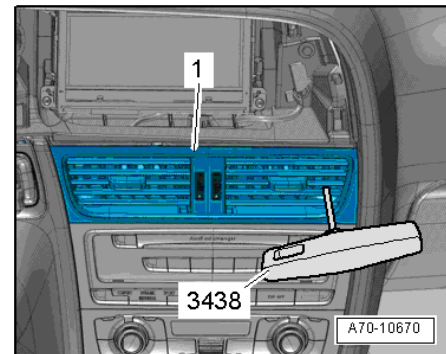

Removing climatization control unit for Concert/Symphony Radio

- Position hook -A- as shown in one of the openings -B- or -C- of air conditioner operating and display unit (Climatronic control unit).

Carefully pull air conditioner operating and display unit (Climatronic control unit) out of centre console in direction of -arrow-.

- Alternatively you can pry it out using wedge tool by squeezing the wedge into sides of the climatronic control unit, but if you hurry to bring it out, you may break the support brackets.



Note

The air conditioner operating and display unit (Climatronic control unit) is held in position by the clips (left and right) in the centre console support brackets. Unplugging connectors from air conditioner operating and display unit (Climatronic control unit)

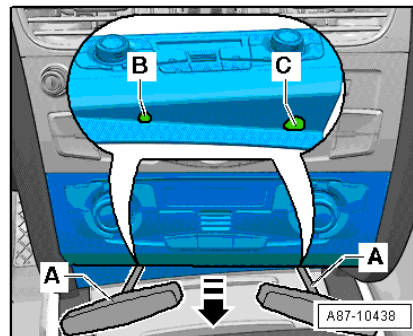

Removing Concert/Symphony radio

Shift selector lever to “S” position (automatic gearbox) or move gear lever all the way to the rear (manual gearbox).

- (If the gear knob interferes while removing, turn keys into ignition mode without pressing brake pedal and then press the pedal, switches gear knob to Drive, turn off the key)
- Switch off ignition and all electrical equipment and remove ignition key.

Removing

- Remove bolts -arrows- at radio -R--1-.
- Pull radio -R--1- out of dash panel.
- Release and unplug connectors at radio -R-.

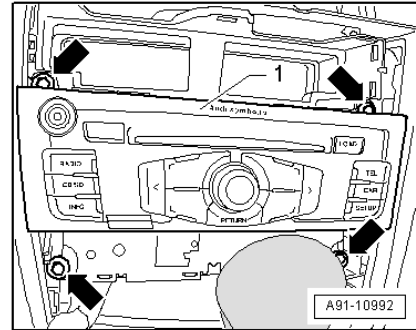
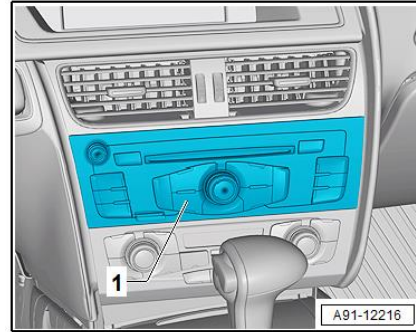

Removing and installing 3G MMI unit



- Insert two VW, Audi radio removal keys for 3G MMI into release slots on control unit 1 for information electronics until they engage. Pointed ends of tool grips must face outwards.
- Pull control unit 1 for information electronics out of mounting frame.
- Press release tabs on control unit 1 for information electronics and remove VW, Audi radio removal keys.
- Release and unplug connectors at control unit 1 for information electronics.

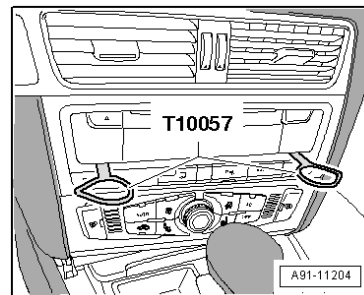

Removing for AMI (If you have one in your glove box)

- Insert two VW, Audi radio removal keys into slots on connection for external audio sources until they engage. Pointed ends of grips must face outwards.
- Pull connection for external audio sources out of mounting frame.
- Release and unplug all connectors at connection for external audio sources.

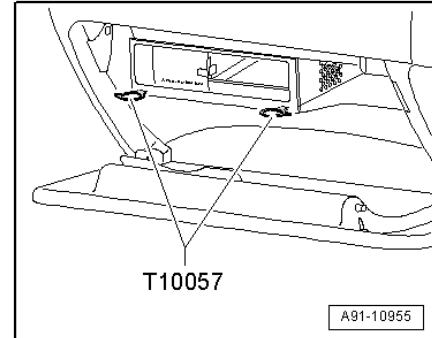

Removing and installing glove box

Removing

- Equipment version with storage box in glove box: Release retaining hooks (left and right) using a screwdriver -arrow- and pull storage box out of glove box.
- Equipment or country-specific version: Remove bolt -1- (top, side).
- Country-specific version with impact damper: Remove bolt -2-.

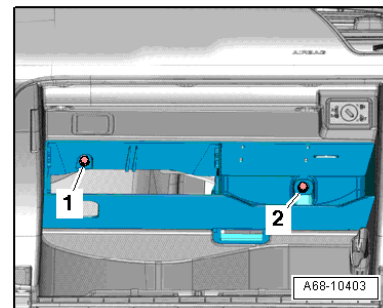
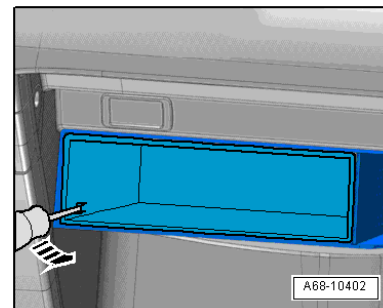

- Remove side dash panel cover (passenger side)
- Open glove box lid and unscrew bolts -arrows-.



Note

- The number of bolts depends on the country-specific version.
- Detach glove box and pull it out far enough so that you can unplug electrical connector at main connector.
-



Open the passenger side dash side cover using a trim removal tool. Unscrew the side bolt.



Passing main cable to screen compartment

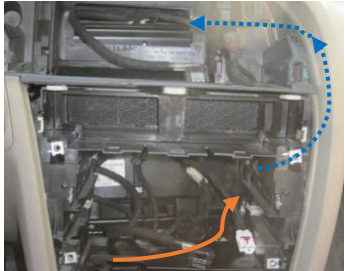

- Start to pass the main cable through the openings in the back of radio/head unit compartment holding 'white main male plug of the cable'. You need to pass the cable with both arms working in both radio compartment hole and the side hole of the glove compartment.

- Continue to read next page

Following the diagram below, route the cables properly.

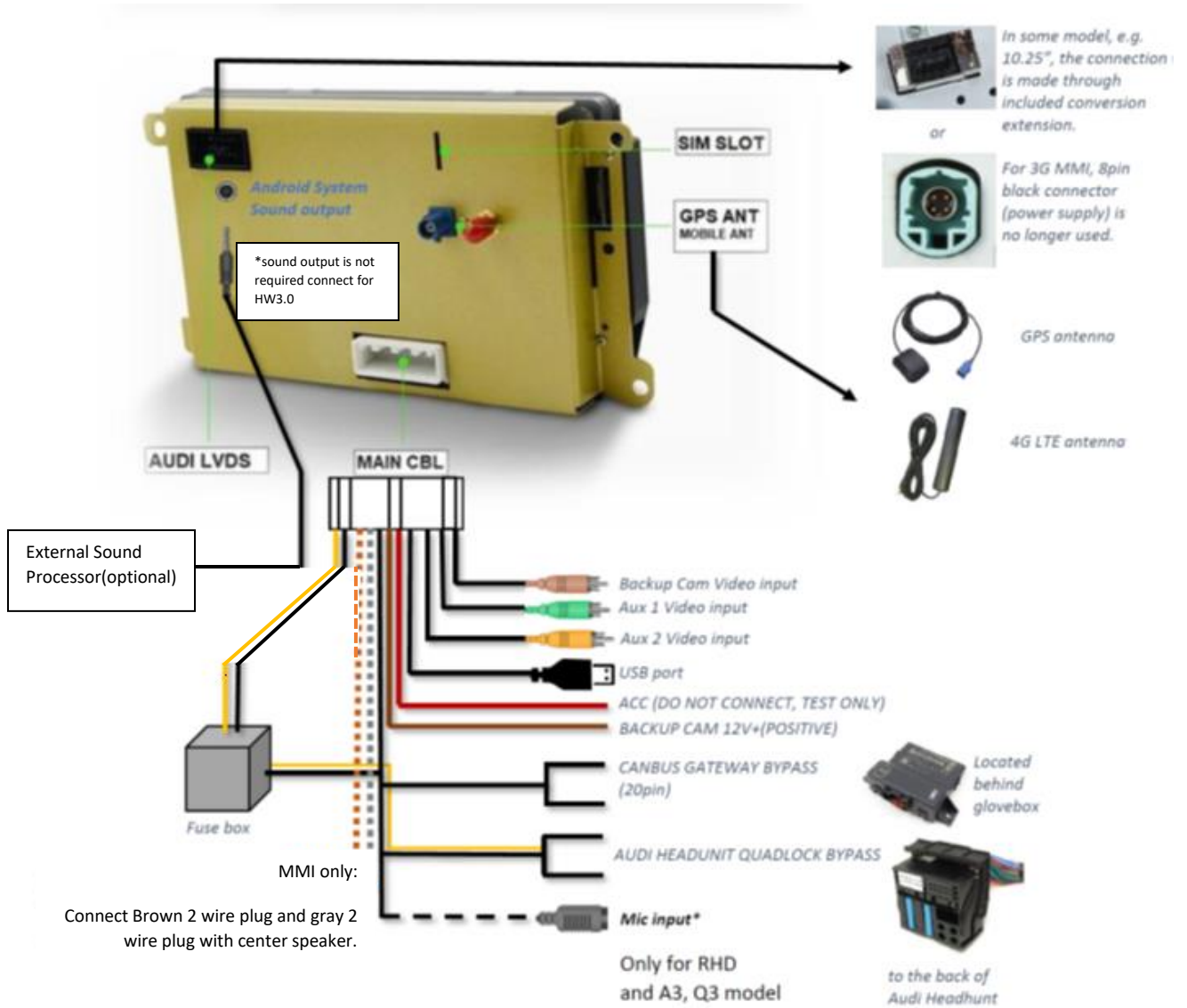



- Locate CANBUS gateway near the glove compartment and install the bypass line. **The car must be turned off when disconnecting and connecting plugs into the CANBUS gateway. Also, do not press start button or key into ignition while CANBUS gateway wiring is disconnected. This will cause many electrical problems and error codes.**



- Make sure every pin is well connected without any pin escape or bent. This is the most critical electronic component for your car and many problems will arise if you don't connect it properly.



- If you have error code with a particular system (e.g. parking break, lane assist) or the car does not start, inspect the CANBUS gateway bypass cable and pins thoroughly. In some cases, male pin on our CANBUS gateway receptacle may be bent or escaped if there was excessive force to plug the connector.

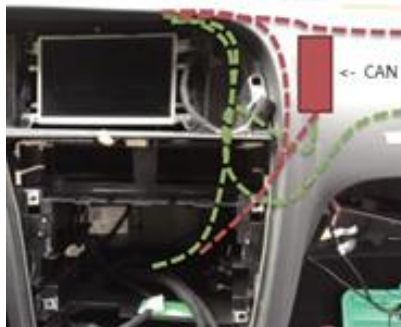

Any cable route must avoid the CAN BUS in any cost. Otherwise, you will have weak WIFI signal, abnormal WIFI downlink speed, noise from speakers and abnormalities.

The Green is the proper route, and the red is the common mistake and bad route.



Join all the connectors properly. Make sure all the connection is tight and well connected. For the quad lock plug there is a lever to release/lock plugs each other also there is latches inside the female plug to make sure tight connection. The female quad lock plug completely covers the male quad lock plug and there must be no escape of the male quad lock.

Installing GPS and Cellular antennas



- GPS Antenna must be connected. This antenna serves as GPS, WIFI 2.4Ghz/5Ghz, and Bluetooth antenna.
- Do not connect RSNV system to the vehicle's original GPS antenna as they are not compatible. Do not use Fakra Y Splitter to mix different GPS systems.



- This Bar type Antenna is for mobile data capability. If you want to use the internal modem of our device, this antenna must be installed. It is not necessary to use this antenna if you do not want to use the internal modem.

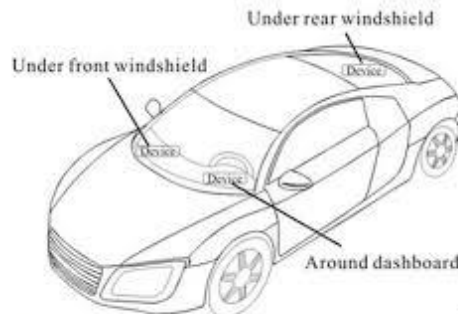
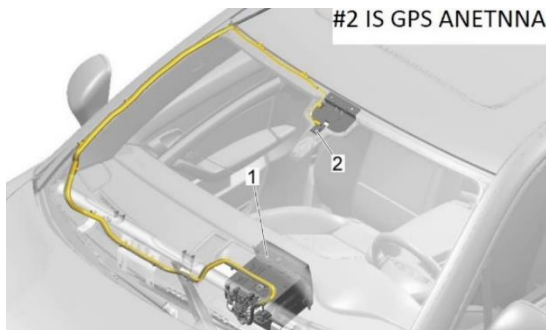

- Under the dash board below the front windshield;

- Preferred location of both antenna is near the rear-view mirror. However, signal reception may vary as each vehicle has different rate of signal penetration.
- Using GPS test plus app as well as mobile signal checking tools available from Google Play Store to determine the best location and angle of the antennas.

Removing A-pillar trim to pass the antenna wires to windshield.



WARNING

There is a curtain airbag behind this trim, and it may ignite if not be careful.

- Switch on ignition.
With ignition switched on, disconnect battery earth wire.
- Before handling pyrotechnic components and restraint systems (e.g. unplugging electrical connector) the mechanic must discharge static electricity by briefly touching the door striker plate, or similar.



WARNING

Observe safety regulations for pyrotechnic components

- Use a screwdriver to carefully unclip cap -1- with "airbag" symbol from A-pillar trim (top).
- Remove bolt -2-.
- Starting at top, carefully unclip A-pillar trim (top) -3- with removal wedge -3409--arrow A-.
- Pull A-pillar trim (top) out of dash panel -arrow B- and detach.

Installing



WARNING

Observe safety regulations for pyrotechnic components

Take care not to trap curtain airbag when fitting A-pillar trim (top).

Installation is carried out in the reverse order; note the following:



Note

If there are still trim clips in the body mounting points, they must be removed and inserted in the trim when installing. Check the clips for damage or deformation and renew them if necessary.

- Use a thread tap to remove any residual locking fluid from threaded hole for bolt for A-pillar trim (top).



Note

If the threaded hole is not cleaned, there is a danger of the new bolt seizing when being screwed in and then shearing off the next time you try to remove it.

- Insert A-pillar trim (top) -1- in mounting -2- of dash panel and sill panel trim (front) in direction of -arrow-.
- Clip in A-pillar trim (top) and fold over lip of door seal.

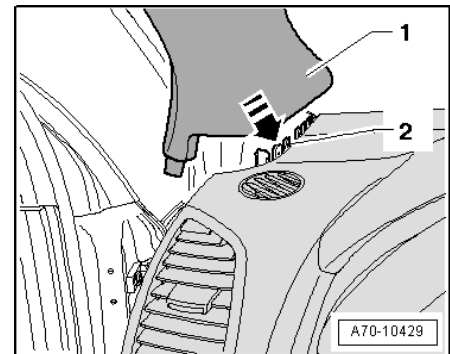
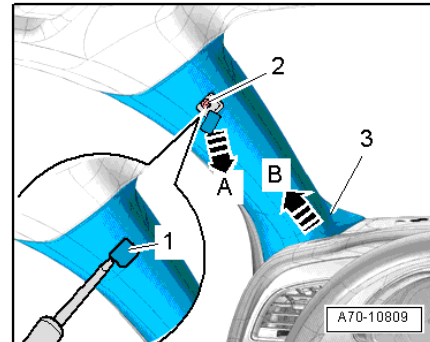

It is not necessary to remove roof lining to pass a wire. Pull down lining by a bit of force and squeeze in the antenna wires.

Activating External Audio Input If this is not done, there will be no sound output

Method 1.

If you have AMI to AUX adaptor, please plug it in to MMI/AMI plug to activate external audio source in Media tab of your Radio/MMI.



Plug this side to your AMI in glovebox or centre armrest

Do not plug this side to anything

Method 2. Coding the system using Vag Com

Concert/Symphony radio

Using VAG COM,
At Radio module-> coding-> long coding helper

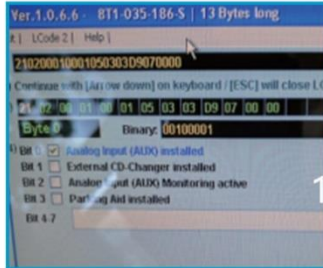

Byte 0, check AUX installed.

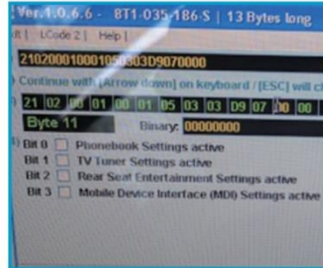

Byte 11, Uncheck Mobile Device Interface(MDI) setting active.



This should activate the AUX

3G MMI/MMI+

Enabling Aux input in MMI

1. Preparation: Enable Green menu using VAGCOM or OBD Eleven
Connect with module 5F – Control Head.
Choose procedure 10 – Adaptation.
Choose Perquisite Channel 6.
Read stored value. By default it should be 0.
Change value to 1 and save it.
Read stored value. Now it should be 1.
Exit

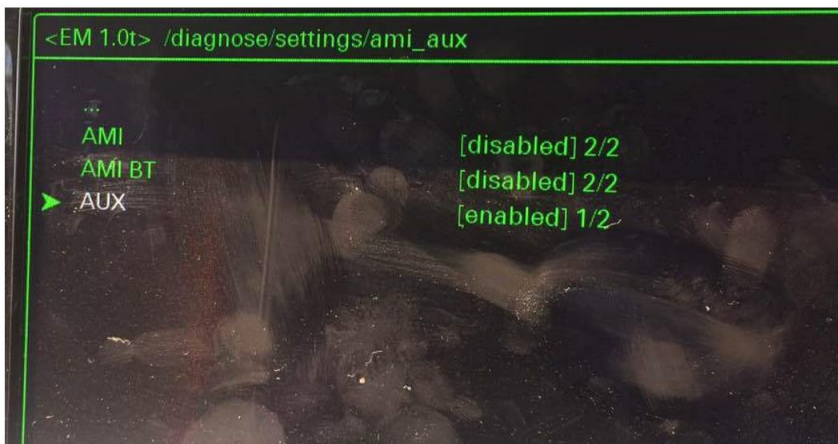

Audi MMI 3G AUX activation procedure

1. Turn key into II position and wait for the MMI 3G system to start. You can also use keyless buttons.
2. Press and hold buttons MENU(or SETUP) and CAR.
3. After couple of seconds hidden green menu will appear. You can now release the buttons.
4. Navigate to diagnose → settings → AMI/AUX.
5. Change the value of “AUX” “disabled” to “enabled” preserving other options.
6. Press RETURN and CAR buttons at the same time to exit hidden green menu.
7. Restart the MMI

7-inch version (RHD, LHD) fascia installation



You must use the provided fascia to exact fitment of screen. Use a sharp knife to release the molten latches. Don't destroy the latches completely as they are required to hold the new fascia. It may be easier to break the original fascia with a cutter from inside. After the removal, glue the new fascia to the original LCD housing.



10.1-inch mounting instruction



Reuse every metal clip and rubber O ring, rubber stopper from the original LCD trim.

8.8-inch mounting instruction



Install the metal plate to the position of original LCD screen. **Mind that the screw tabs have wide holes for the installer to mount new screen in an exact position. Do not screw tight before you confirm the fitment of LCD screen with the provided housing. If necessary, make the screw tabs trimmed down and screw holes wider so that you can mount it further left.** If the position is right, then screw the main device to two upper screw taps.

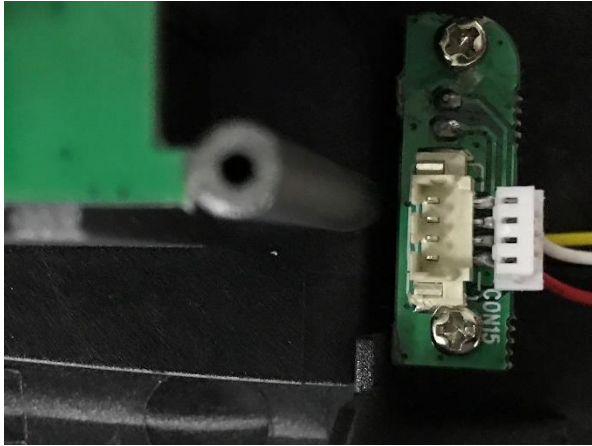

This is mic and reset button assembly located in the plastic housing. Make sure the assembly is connected with the wire in picture from the device. Otherwise, the device may not function properly. **(Sound quality will be bad if neglected)**



Connect new hazard flasher using provided hazard flasher extension.



In the case that you get 'airbag warning' indicator ON in the instrument cluster **and you don't have 'pass. Airbag off'** sign in your original hazard flasher, cut purple or white wire and clear the DTC code using VAG diagnostic interface such as Carista, OBD Eleven, or VCDS



WARNING

YOU DO NOT CUT IF YOU HAVE 'PASS. AIRBAG OFF' LETTERINGS IN YOUR HAZARD(EMERGENCY) FLASHER.

YOU SHOULD NOT CUT ANY WIRE IF YOU HAVE 'PASS. AIRBAG OFF' LETTERINGS IN YOUR FLASHER.



Reuse every metal clip and rubber O ring, rubber stopper from the original LCD trim.

10.25-inch mounting instruction



Metal Frame goes to Replacement the factory LCD location.

Replacement Hazard Flasher

Fixture screws to the metal frame

10.25" Device unit



Using a cutting tool, empty out the LCD fascia of the original LCD frame and remove the original hazard flasher.



- Install the metal plate to the position of original LCD screen.

Mind that the screw taps in four edges have wide holes for the installer to mount new screen the exact position. Do not screw tight before you confirm the fitment of LCD screen with the provided housing.

- If the position is right, then screw down plastic supporting frame with four screws.

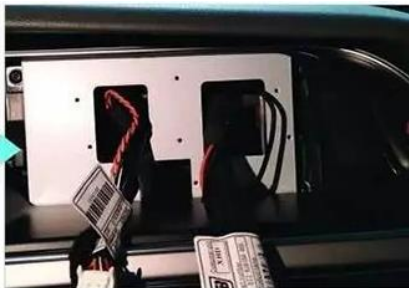

- Pass the wires through two holes. Identify what wire should pass which hole.



- Connect new hazard flasher using provided hazard flasher extension.



Mount the head unit by sliding into guide rails and open the screw covers in the back side of the main head unit(tablet) and screw down two large screws to fasten the tablet permanently.

In the case that you get 'airbag warning' indicator ON in the instrument cluster, **press the button on the main PCB or the extension wire** and clear the DTC code using VAG diagnostic interface such as Carista, OBD Eleven, or VCDS.

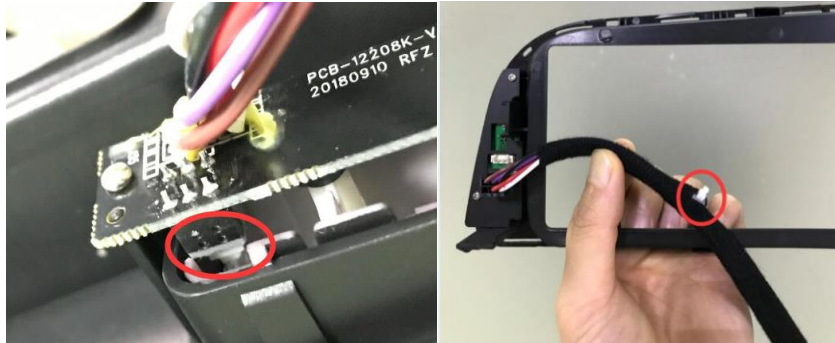

For 10.25" unit, there are five connectors.

1. 28 pin white main plug for various wires including power
2. Gold plated antenna connector for mobile modem
3. 3.5 mm silver color audio output jack
4. Blue GPS antenna connector
5. Audi original display signal(LVDS) input port.

For LVDS input port, there is a conversion extension included in the package depending on your original infotainment type.



In some model, e.g. 10.25", the connection is made through included conversion extension.

or



For 3G MMI, 8pin black connector (power supply) is no longer used.

insert in right direction.

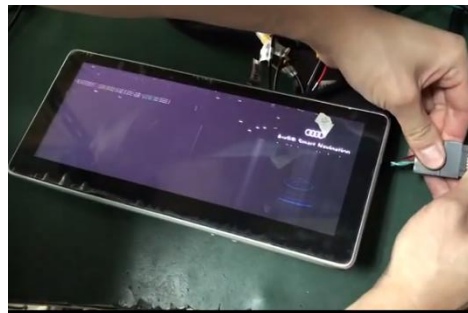

For 10pin LVDS cable, if original Audi screen scrambles like the picture, then you connected the original 10 pin male plug upside down. Verify the plug direction and

Connecting CarPlay/Android Auto using CarPlay/Android Auto dongle

Connect RSNV USB port -> Black small filter -> Main CarPlay/Android Auto dongle -> your phone using Genuine iPhone cable or Belkin USB-C cable for Android Phones.

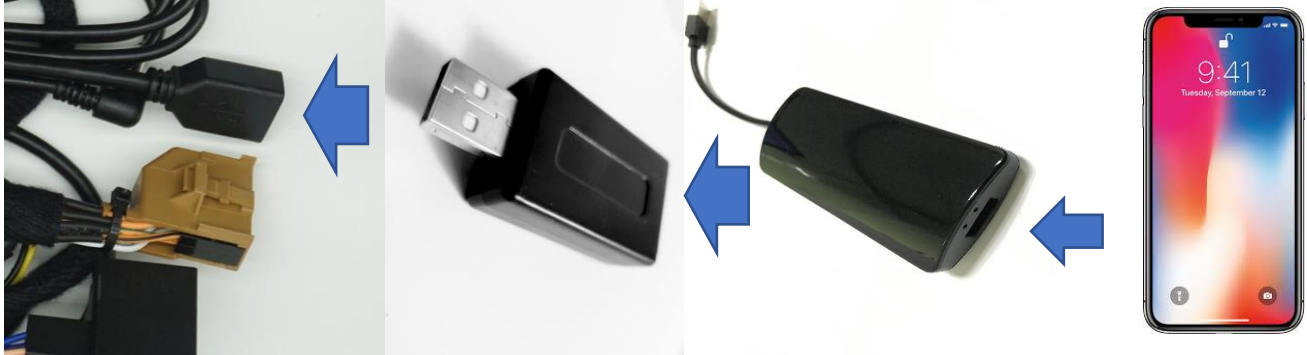

Once connected, go to 'Apps' and run 'AutoPlay'

Wired over USB cable

Or wireless if wireless dongle

- Make sure the filter is placed firmly and do not press the filter with excessive power. Usually broken or loose filter is the cause for CarPlay/Android auto to crash.
- Must remove the filter in case you need to restore the system firmware using Laptop USB cable restoration method. Visit wiki.rsnv.com for more details
- Must use the filter always with the dongle otherwise CarPlay/Android Auto will crash often.
- In the case of wired connection, it's important to use USB-IF certified cable for Android less than 6 foot or Apple MFI certified lightening cable.
- In the case of wireless connection, you must acknowledge that the connection may drop or the service may crash upon strong EMI (Electro-Magnetic Interference)
- For wireless connection, connect your phone Bluetooth to 'Autobox_XXXXXX'
- See separate manual for the use of the CarPlay/Android Auto dongle.

SIM card insert direction

10.25" Models



- Insert SIM card metal contact side facing down to the device like the picture.

7", 8.8", 10.1" SIM card direction



- Decide SIM card direction in relation to the white plug shape direction. The white plug's locking element side and the cut mark of the SIM card is facing each other.

Clearing 'External Audio Source Active' message in instrument cluster

When you are using the steering wheel left roller button on Android, your instrument cluster would keep show 'External Audio Source Active' message. To clear this message and bring back the speedometer, use the Reset button on the bottom of the right Multifunction wiper control switch stalk instead of any other button in the steering wheel.



Steering button features



- 8 - Short press(<3sec): launch Audi original voice command, Long press(>3sec): Google Voice Search
- 9 - Volume control
- 10 - Launch GPS navigation app designated in Realsun Settings
- 11 - Browsing in RSNV Audi style launcher: UP, Down, Press: 'Confirm'
- 12 - Serve as 'Back' button in Android

MMI button features *No button in Concert/Symphony radio is supported

Current layout:

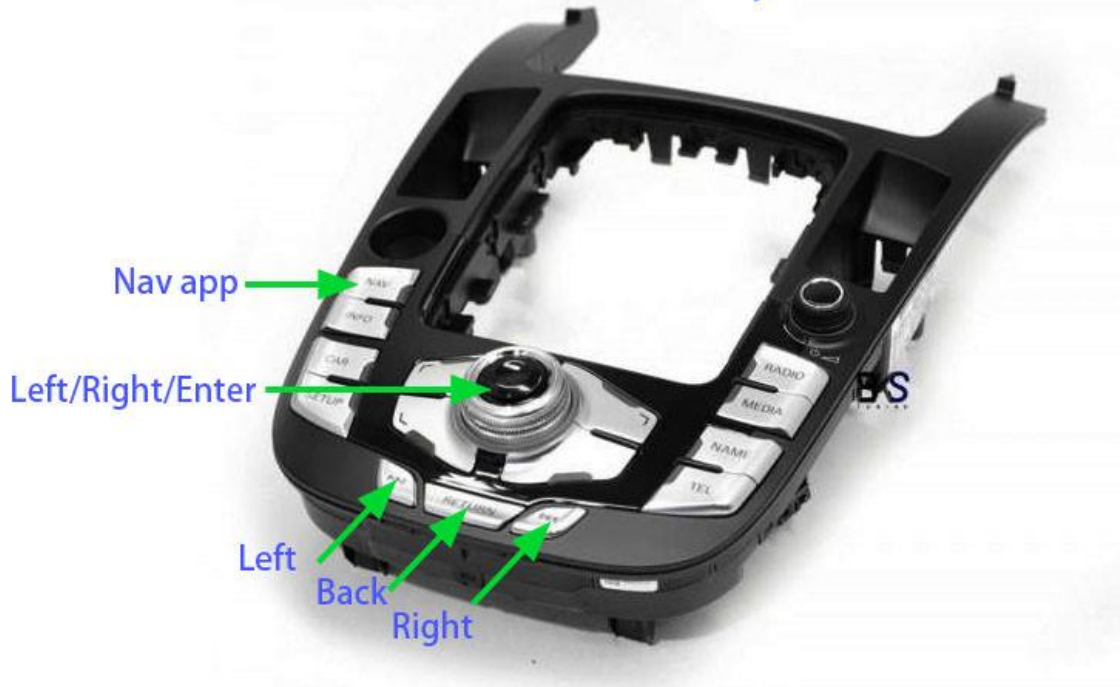

*RSNAV will try to assign more features to the buttons in android.

Frequently Asked Questions

Q: The system turns on itself briefly showing reverse view when a door is unlocked or a door is open.

A: This is normal. The device starts to boot up when there is electronic event such as 'door open' or unlock. This is to monitor the devices work normally. RSNAV will remove this feature if there is many customer feedbacks.

Q: The system does not turn off after motor stops and doors are already locked.

A: The system will turn off the screen 5 minutes later the car is locked, and the entire system will go off 10 minutes later the car remain stationary and locked. This is to ensure the Android system does not go off on short stops such as gas station, convenience store stop over.

Q: The system does not remember last activity before turns itself off.

A: To prevent the system completely drains battery, the system completely goes off after 10 minutes of inactivity of engine(motor). This is the same as 'hard reset' of any tablet or smart phone. RSNAV is considering changing this logic to 'Sleep only while the motor is off up to 15 hours inactivity'. Nevertheless, such change will consume more of your car battery.

Q: There is no sound from the android system.

A: Make sure you selected 'external audio source' in [Media] of your Radio or MMI system. Also, make sure the system's sound output connected properly as shown in the diagram of this manual. Remember, RSNV system is equipped with external noise isolator which make the system different in terms of wiring.

Q: Android's sound volume is low compared to original radio or infotainment system.

A: Run 'Volume Adjust' from App picker and adjust independent volume controls as you may want. Also, when the Android system warns for hearing loss, make sure to confirm it to be deactivated. Also, in Realsun setting, max out the default system volume.

Q: In reverse view, dynamic parking guideline stopped working

A: This is a bug. Mostly it comes back detaching the main connector and reconnect. RSNV is currently working on a solution. It will be fixed in later CANBUS software update.

Q: The system keeps automatically switched to factory original interface even directed to stay in Android.

A: In Realsun setting, make sure 'Parking key' is disabled. 'Parking view button' is equipped with certain Audi vehicles with OEM backup camera. If the option is enabled without having the button installed from factory, this adverse effect will occur. If this happens with the feature disabled, make sure if you removed shipping protection film in touch glass. (Especially 7" unit).

Q: My 7" unit arrived with scratched and bubbled screen.

A: Don't worry. There is two layer of shipping screen protector applied to the 7" display. The first layer is obvious that most people remove it immediately, but the second layer is very discrete as it was applied by the touch glass manufacturer and RSNV assembled plastic frame on the top of the touch glass. Just using a needle, poke an edge of the screen carefully and start to lift the fine film layer slowly. In some point, it will lift easily. Do not poke the screen too hard as you may scratch the touch glass itself.

Q: The system sounds lack of bass compared to original system.

A: If your system is equipped with external mic port, you must plug the mic in, otherwise, the noise isolator will remove the entire low frequency from your sound system.

Q: Where is the reset button?

A: 7" unit: far left side hole of the screen. 8.8" unit: far right-side hole below the hazard flasher. 10.1" unit: The hole above, 'RST' marking. 10.25" unit: on left side wall of the display, there are two holes and lower one is the reset hole.

Q: The system sounds lack of bass compared to original system.

A: If your system is equipped with external mic port, you must plug the mic in, otherwise, the noise isolator will remove the entire low frequency from your sound system.

Q: OEM reverse camera is not showing.

A: Change setting to 'original backup camera' in Realsun Setting under Camera selection option. If you have manual transmission with OEM reverse cam, please contact us for more information.

Q: MMI console is not responsive

A: Wrong CANBUS firmware version is installed in your system. Please contact us.

Q: Original Audi factory interface screen goes black intermittently, and CarPlay, Android Auto is crashing often.

A: That is a bug of Auto Play Box app which is used for CarPlay, Android Auto.

Update both the Auto Play Box app and dongle firmware using the update feature inside the Auto Play Box app. Also, the dongle is very sensitive to physical connection quality. Thus make sure the black USB filter dongle is connected before the white dongle, connect the white dongle to the port of black USB filter. If connection is keep breaking, contact us.