



# 12'X8' - 2x4 Model Garden In A Box Assembly Manual

Revision #12  
April 5, 2024

Licensed Under US PATENTS 7,424,787; 7,490,435

Thank you for purchasing a 12'x8' Garden In A Box. Please take the time to identify all the parts prior to assembly.

### Safety Points and Other Considerations

Please follow this instruction manual when assembling your Garden in a Box and retain the manual for future maintenance purposes.

Please use Safety Eyewear and Gloves while Assembling. Be sure to read and follow all operating instructions for any tools used during assembly. Remember - NO SAW CUTTING IS REQUIRED!

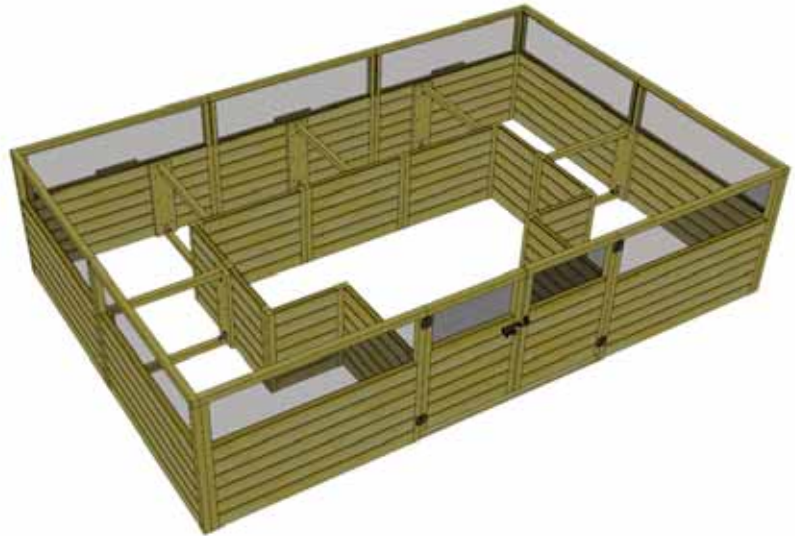

**Estimated Assembly Time for the Garden in a Box = 5 Hours.**

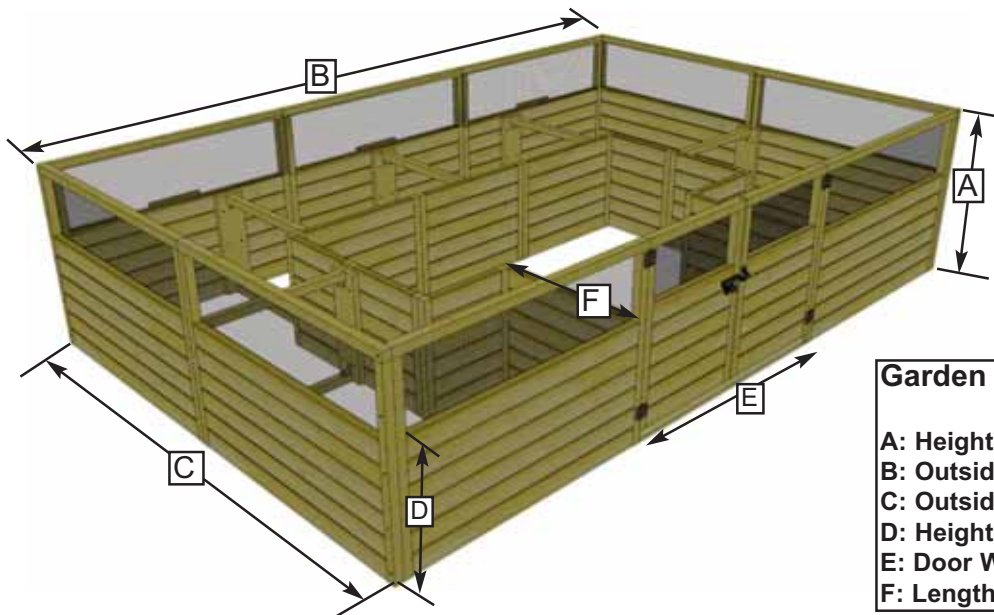

### **Garden in a Box Dimensions:**

- A: Height = 33 1/2"
- B: Outside Width = 141"
- C: Outside Depth = 92"
- D: Height to Bottom of Screen = 21"
- E: Door Width = 46"
- F: Length of Inner Panel Sections = 60"

**In the event of a missing or broken piece, simply call the Outdoor Living Today Customer Support Line @ 1-888-658-1658 within 30 days of the delivery of your purchase. It is our commitment to you to courier replacement parts, free of charge, within 10 business days of this notification. Replacement parts will not be provided free of charge after the 30 day grace period.**

# Exploded View & Parts List for 12'x8' Garden In A Box

## Parts List

### Panel Section

- Part A** 9 - Side/Rear Panels  
46" wide x 33 1/2" high
- Part C** 2 - Door Panels  
22 3/4" wide x 31 1/2" high
- Part D1** 2 - Interior Panels (Rear)  
41 1/2" wide x 21" high
- Part D2** 2 - Interior Panels (Sides)  
32 1/8" wide x 21" high
- Part D3** 2 - Interior Panels (Front)  
26 3/8" wide x 21" high
- Part D4** 2 - Interior Panels (Narrow)  
18 1/2" wide x 21" high

### Rib Section

- Part F** 10 - Bed Rib Connecting Plates
- Part G** 10 - Bed Rib Frames (Sides)  
1 1/2" thick x 1 1/2" wide x 25 3/8" long
- Part I** 1 - Door Threshold (**Not Shown**)  
3/4" thick x 3 1/2" wide x 46" long

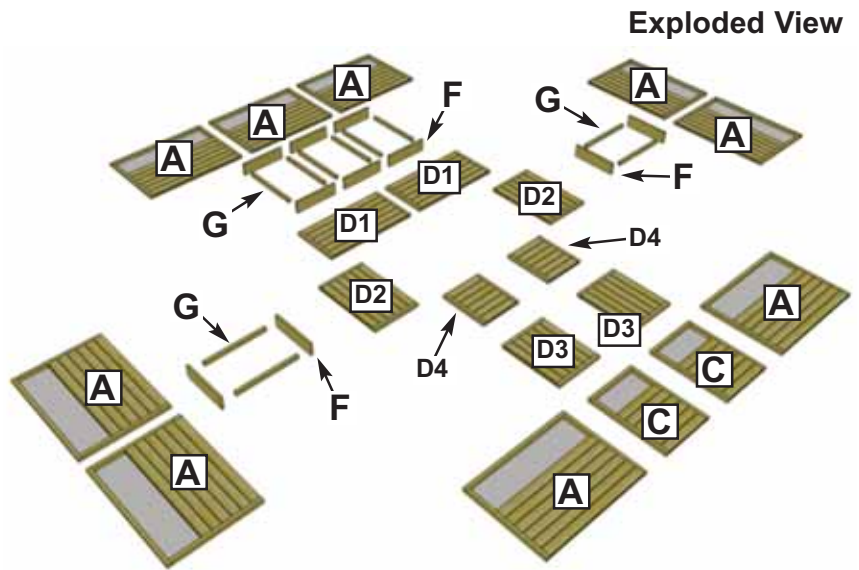

## Hardware Kit (Provided)

S1 - 2 1/2"  x 100 Pcs.

S3 - 2"  x 70 Pcs.

SS1 - 1"  x 55 Pcs.

SB1 - 3/4"  x 38 Pcs.  
Black Headed Screw



Y4 - Black Drop Latch x 1 Pc.



Y7 - Plastic Hinge x 4 Pcs.



Y2 - Bracket x 22 Pcs.



BR1 - Square Drive Bit x 1 Pc.



Y6 - Cane Bolt

## Tools Required (Not Provided)



Screw Gun/Drill



Tape Measure



Level



Wood Clamp



Shovel



1/8" Drill Bit

## Safety Equipment Required (Not Provided)



Safety Glasses



Work Gloves

**To prevent soil seepage and extend the life of your garden bed, we recommend you line the inner walls with landscape fabric or plastic sheeting (not provided) before filling with soil.**

# Important Information For Homeowner

## Selecting A Location - Garden Setting Or Patio

Walk around your property and make notes of the following:

- Sunny spots.
- Slope of the land.
- Light blocking trees and high buildings.

Don't hide your Garden away in a dark corner.

Ensure you have easy access to it.

Place your Garden on a level piece of land with good drainage. Take into account existing paths and utilities such as electricity and water.

Having a water supply at hand avoids carrying heavy watering cans from the tap to the garden bed.

## Preparing The Ground For A Garden Setting

Level ground beneath the raised bed prior to assembly. Your new Garden will be open on the bottom which enables plant roots to access soil nutrients below ground level.

Lay down a sand perimeter base for the Garden Frames to sit on if possible. Sand offers excellent drainage and will make it easier to level bed frames.

The Garden can also be located on almost any flat surface - sand, pebbles/gravel, concrete or asphalt. Preparing the soil and the sand base beneath the Garden will not be necessary. Twenty inches of soil should be plenty for most types of vegetables and flowers. Please check growing instructions for root depths prior to planting.

## Adding a Liner

Consider lining the Garden with landscape fabric (not included) to prevent soil from seeping out. Liners also provide insulation for the soil and helps control temperature fluctuations. In addition, liners separate weeds from seeds and can drive away pests like gophers and moles that can damage your plants.

**Note: Raised Garden Beds qualify for our Limited 3-Year Warranty only if the interior of the beds is fully lined with a waterproof barrier before filling the Garden with soil.**

## Once The Garden Is Assembled - Add Soil

Use a quality soil ideal for growing vegetables, for the top 12 inches (approximately 3 cubic yards or 28 - 32 wheelbarrows). Any soil is suitable for the bottom 8 inches (approximately 1.5 cubic yards). Or, you may fill the bottom 8 inches with gravel, pebbles, rocks or wood chips.

Most 1/2 ton pickup trucks can haul 1 cubic yard of top soil if this is an option for you. Consider having soil delivered as opposed the buying bags by the cubic foot. There are 27 cubic feet in 1 cubic yard.

Fill the Garden to the top of the wood framing (the start of the metal screening). In a few weeks, the soil will settle/drop about 4-6 inches. Top up if necessary.

Add soil within two weeks of planting. Fertilizer may be required. Check with your local garden growing expert before adding any fertilizer!

## Arranging & Planting Crops

Since requirements vary from region to region on how to arrange and plant crops, we recommend researching thoroughly before planting.

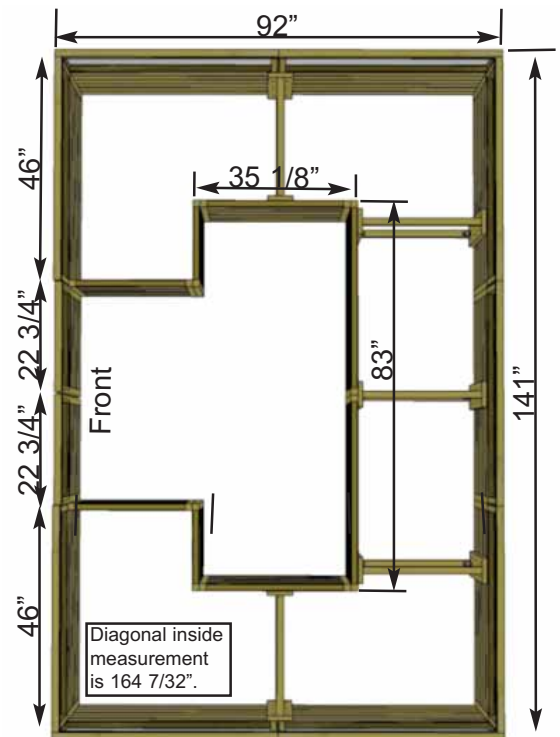



**1.** Orientate **Side/Rear Panels** and **Door Panels** as illustrated (**their Screens positioned to the inside**).

Parts (Steps 1 - 8)  
**A - Side/Rear Panels**  
 (46" x 33 1/2") x 9  
**C - Door Panels**  
 (22 3/4" x 31 1/2") x 2

Hardware (Steps 1 - 2)  
**S1 - 2 1/2" Screws**  
 x 1 total

**Important:** Before positioning Panels, lay out footprint and level ground perimeter. If possible, dig a small trench and backfill with 1 or 2 inches of sand. Sand will make it easier to level panels.

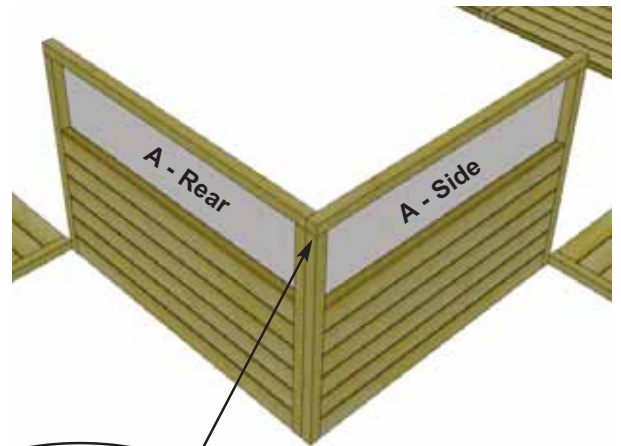
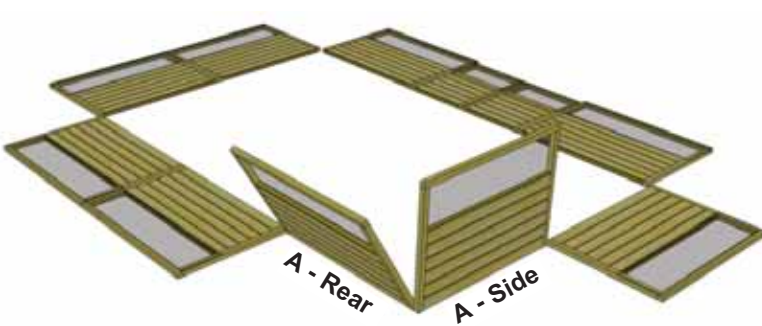
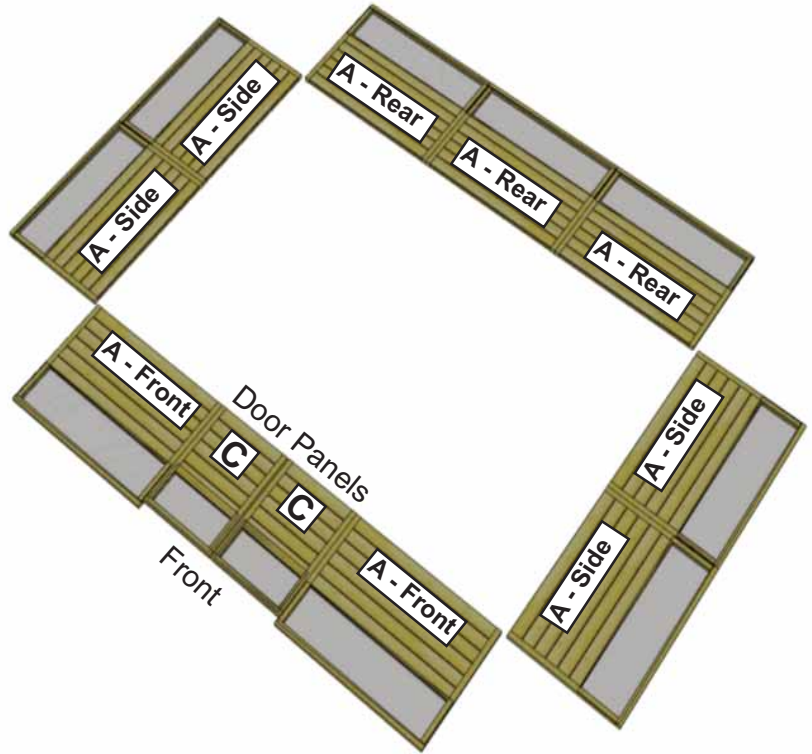

Frames even.

2 1/2" Screw

**2.** Starting in rear corner, position **Side & Rear Panels** together so framing is flush at top and sides. When aligned, attach frames together at top with **1 - 2 1/2" Screw**. Use **Wood Clamp** to hold frames together. Pre-drill rear frame first with 1/8" diameter bit to prevent wood from splitting.

**Important:** You can find the **Square Drive Bit** for the screws in with the **Hardware Kit Bag**.

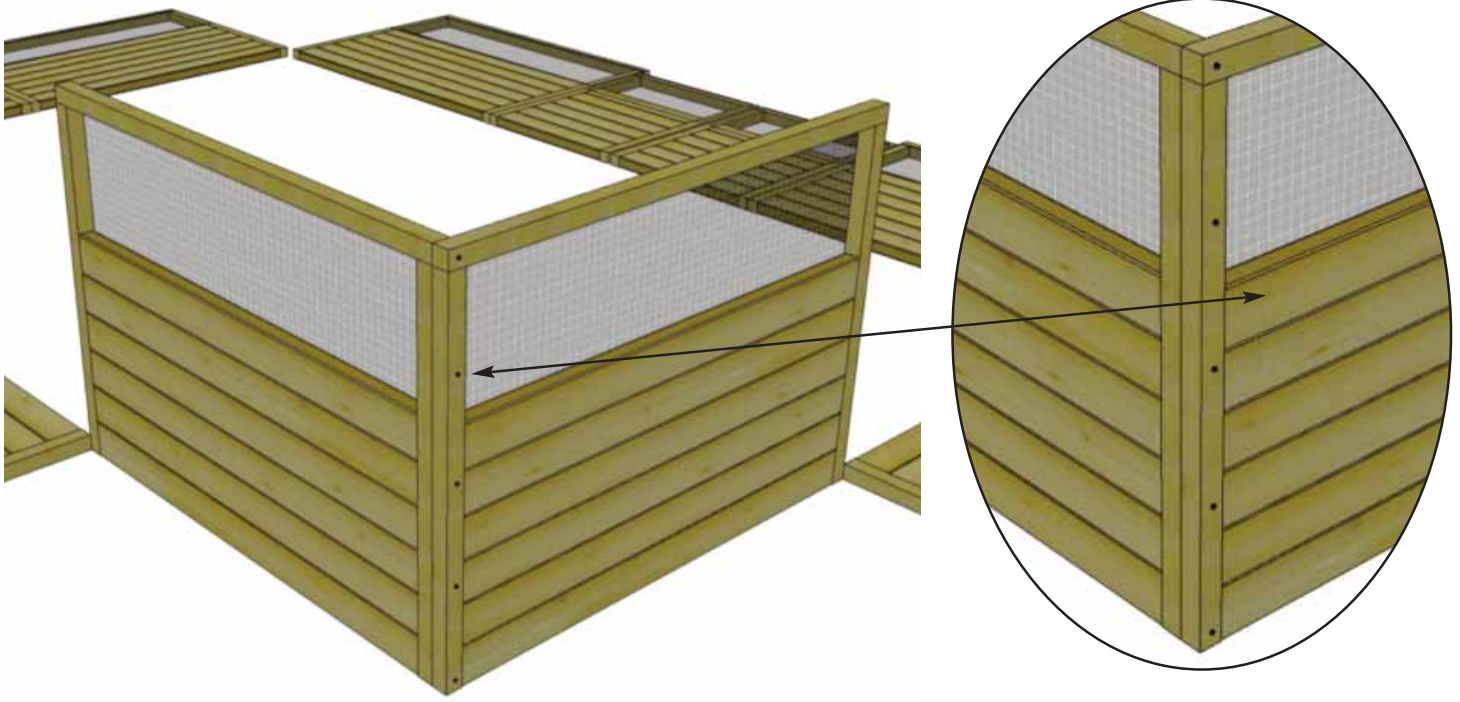

**3.** Attach panels completely together using **4 additional 2 1/2" Screws** evenly spaced on panel framing. Make sure panels are aligned prior to screwing. Pre-drill first to prevent wood from splitting.

Hardware (Steps 3 - 4)  
**S1 - 2 1/2" Screws**  
 x 9 total

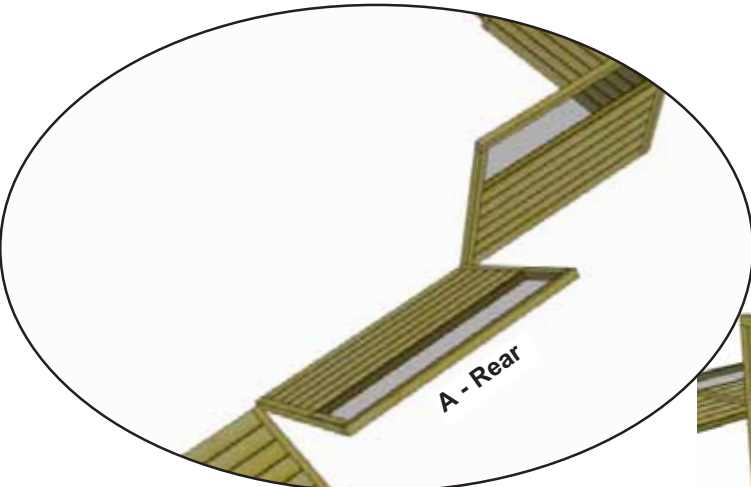

**Important:** Be sure to level the ground so panels sit evenly.

**4.** Position and attach the **2nd Rear Panel** together making sure both rear frames are aligned at top and sides. Use **2 - 2 1/2" Screws** in the upper screen frame area as illustrated to the right. From the inside, angle screw **3 - 2 1/2" Screws** into panel framing to secure completely. Use **Wood Clamp** to hold panels tight together while screwing and pre-drill first to prevent wood from splitting.

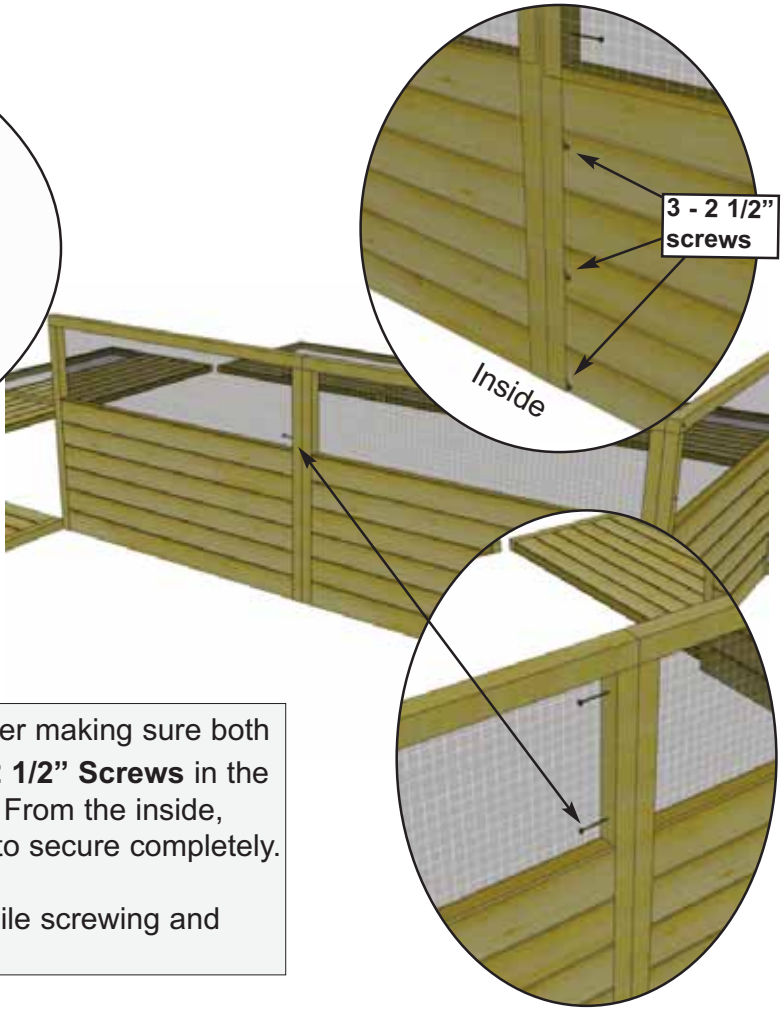



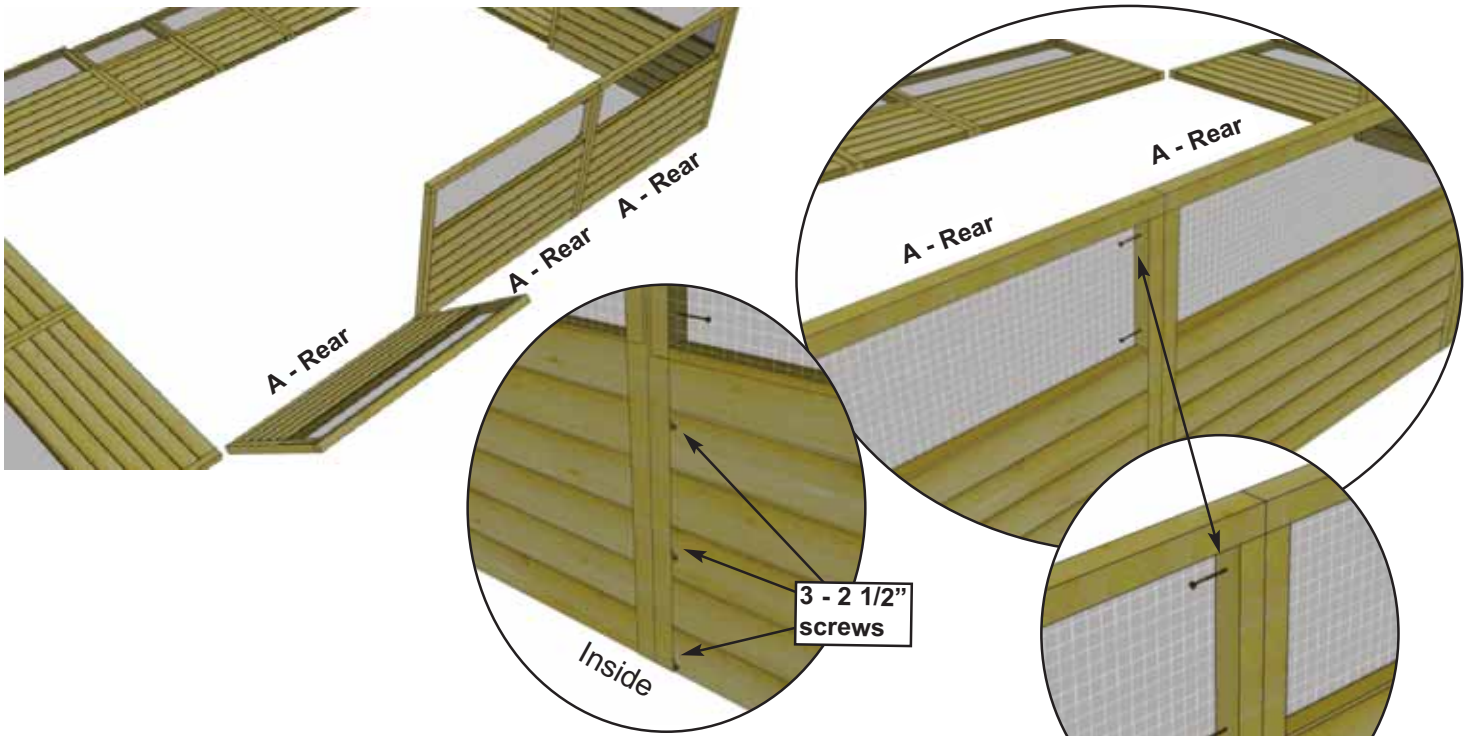

**5.** Align and attach the **3rd Rear Panel** as per **Step 4**. Use **5 - 2 1/2" Screws** to secure.

Hardware (Steps 5 - 6)  
**S1 - 2 1/2" Screws**  
 x 10 total

**Important:** Be sure to level the ground so panels sit evenly.

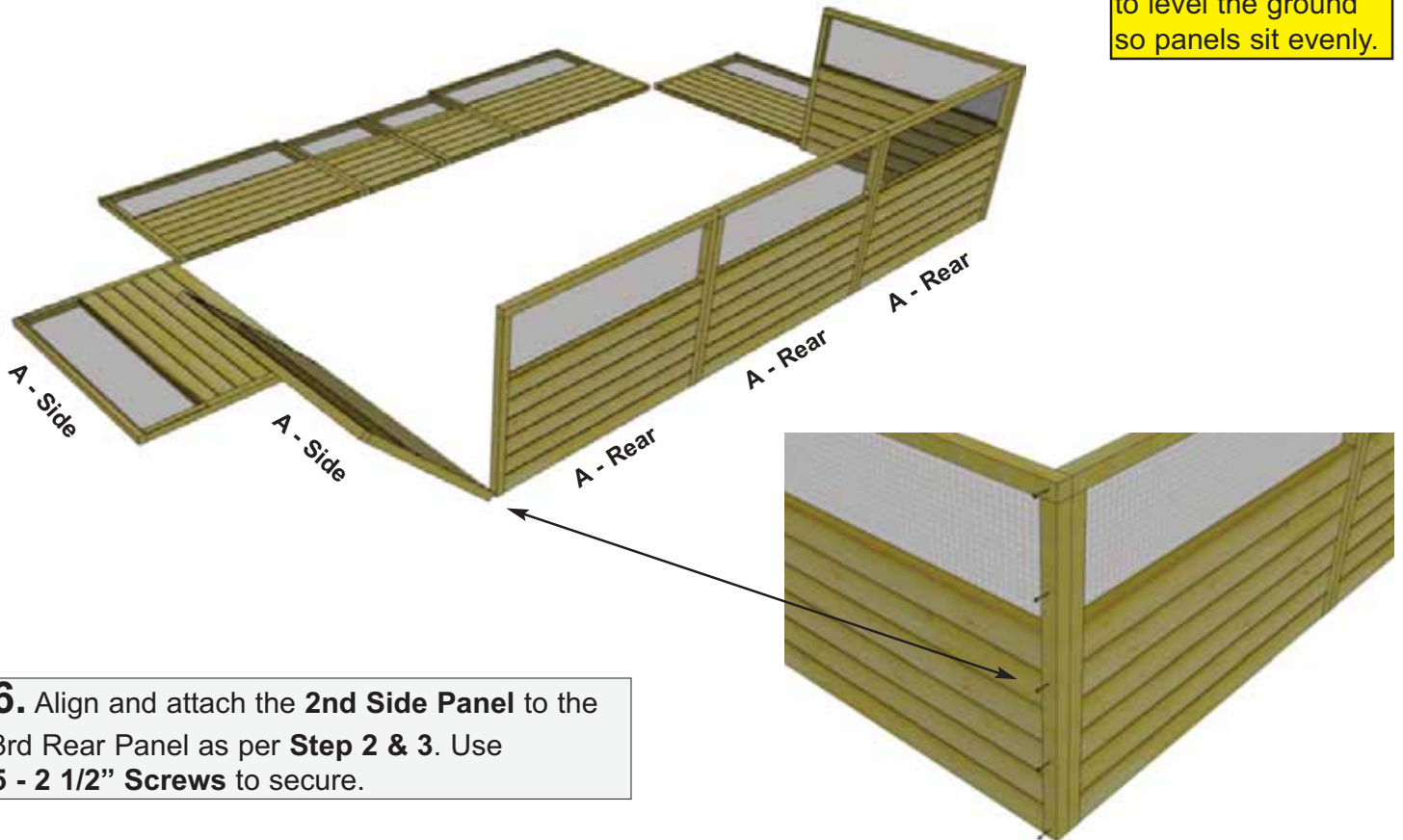

**6.** Align and attach the **2nd Side Panel** to the **3rd Rear Panel** as per **Step 2 & 3**. Use **5 - 2 1/2" Screws** to secure.

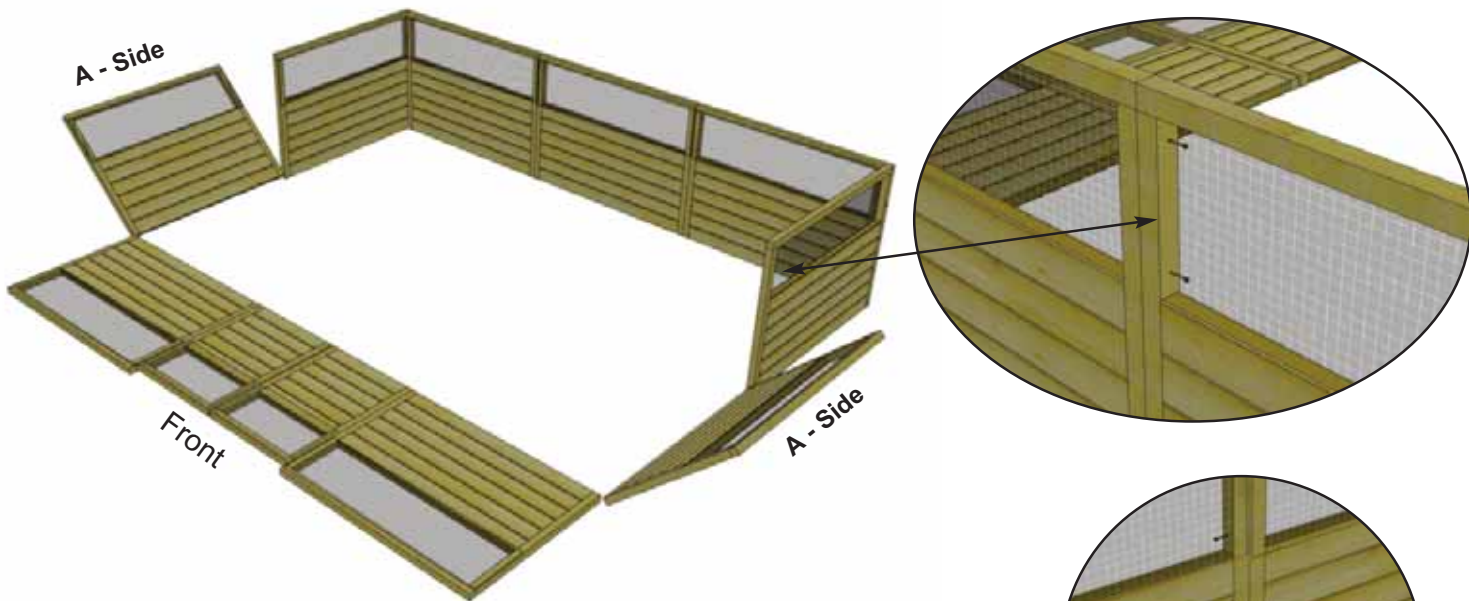

**7.** Align and attach the remaining **3rd & 4th Side Panels** as per Step 4 & 5, to the current secured Side Panels. Use **5 - 2 1/2" Screws** per panel to secure.

Hardware (Steps 7 - 8)  
**S1 - 2 1/2" Screws**  
 x 20 total

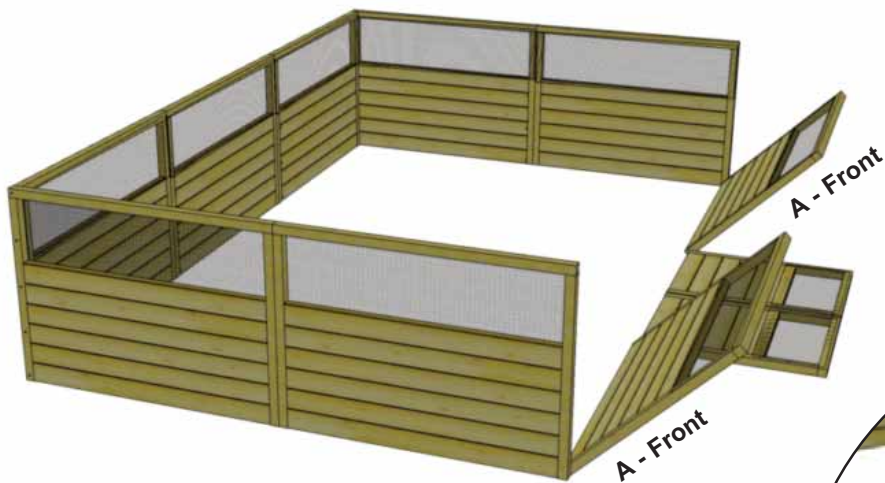
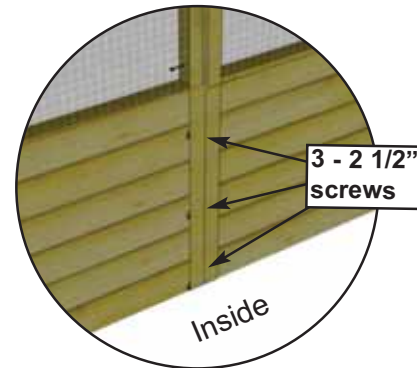

**8.** Align and attach the 2 remaining **Front Panels** as per **Steps 2, 3 & 6**. Attach with **5 - 2 1/2" Screws** per panel.

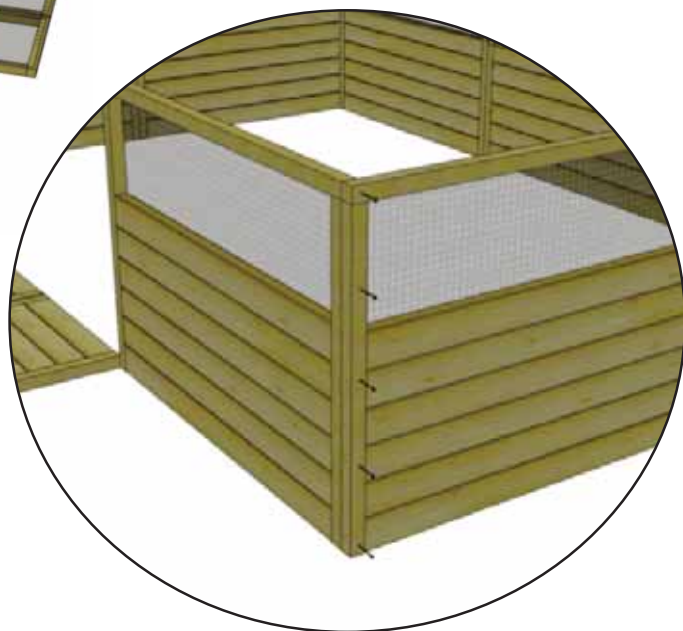



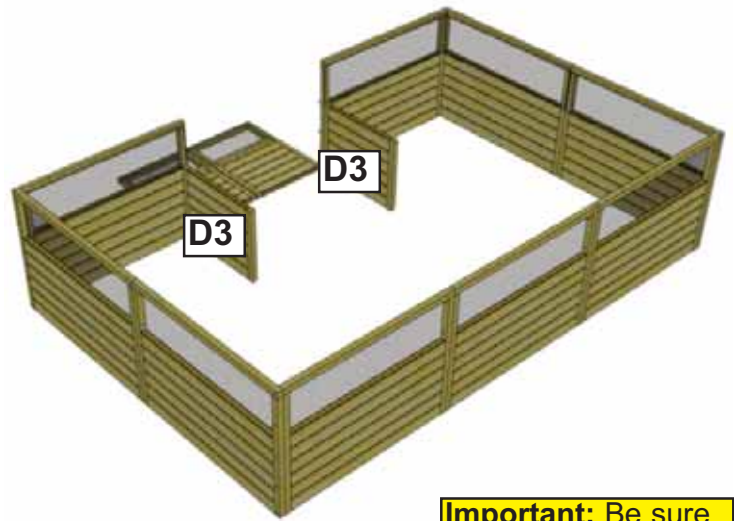
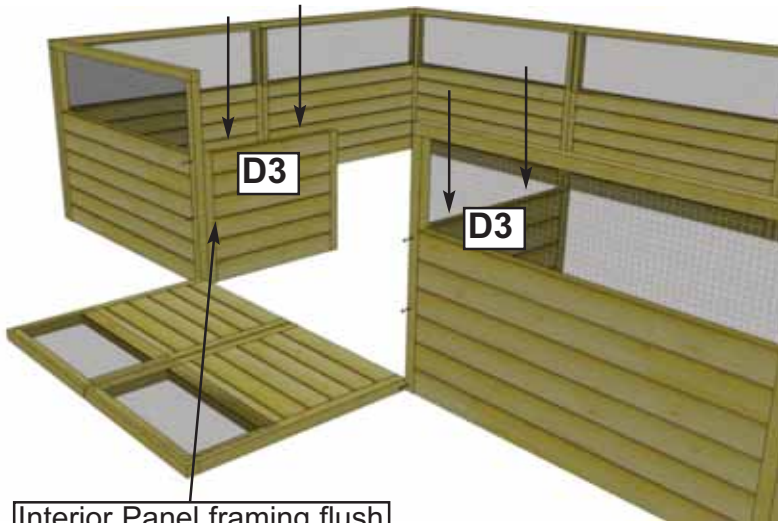

**Important:** Be sure to level the ground so panels sit evenly.

**9.** Locate all **8 Interior Panels**. Align frame of the **2 Front Interior Panels** with the inside of the frame of the Front Panels from **Step 8**. Screw from front panel framing into interior framing with **3 - 2 1/2" Screws** per board.

Hold framings tight together while screwing.

Parts (Steps 9 - 13)

- D1 - Interior Panels (Rear)** (41 1/2" x 21") x 2
- D2 - Interior Panels (Sides)** (32 1/8" x 21") x 2
- D3 - Interior Panels (Front)** (26 3/8" x 21") x 2
- D4 - Interior Panels (Narrow)** (18 1/2" x 21") x 2

Hardware (Steps 9 - 13)

- S1 - 2 1/2" Screws**  
x 27 total

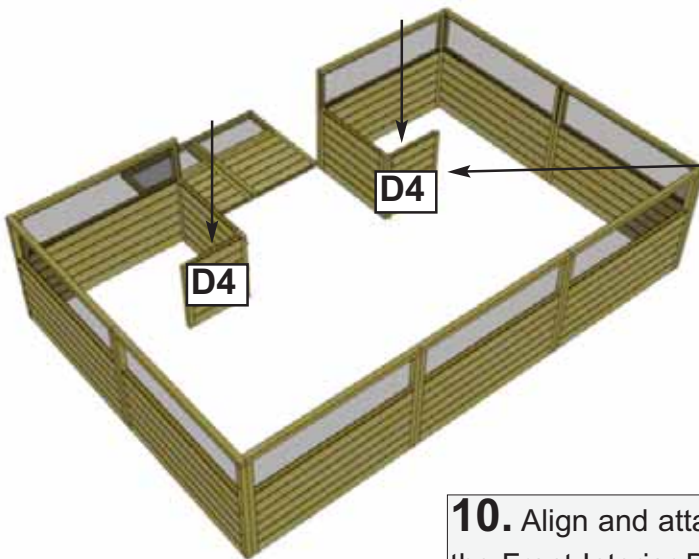

**10.** Align and attach framing of both **Narrow Interior Panels** to frame of the Front Interior Panels as per **Step 9**. Attach with **3 - 2 1/2" Screws** per panel.



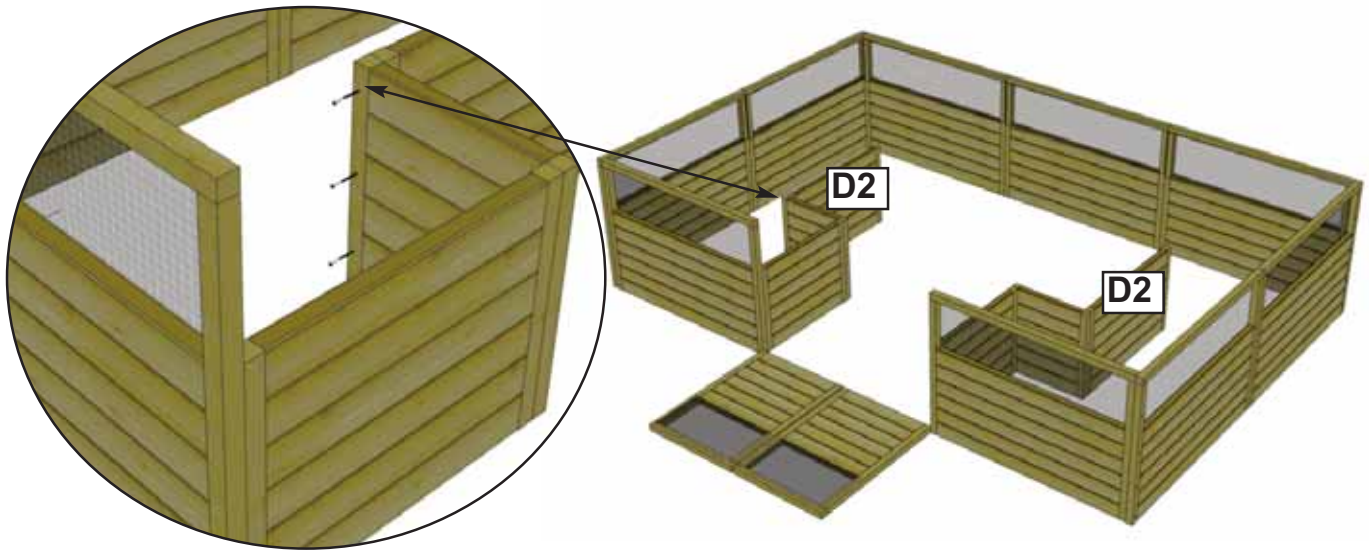

**11.** Align and attach both **Side Interior Panels** as per **Step 9 & 10**. Attach with **3 - 2 1/2" Screws** per panel.

**12.** Align and attach both **Rear Interior Panels** to the frame of the previous Side Interior Panels, as per **Step 9, 10, & 11**. Attach with **3 - 2 1/2" Screws** per panel.

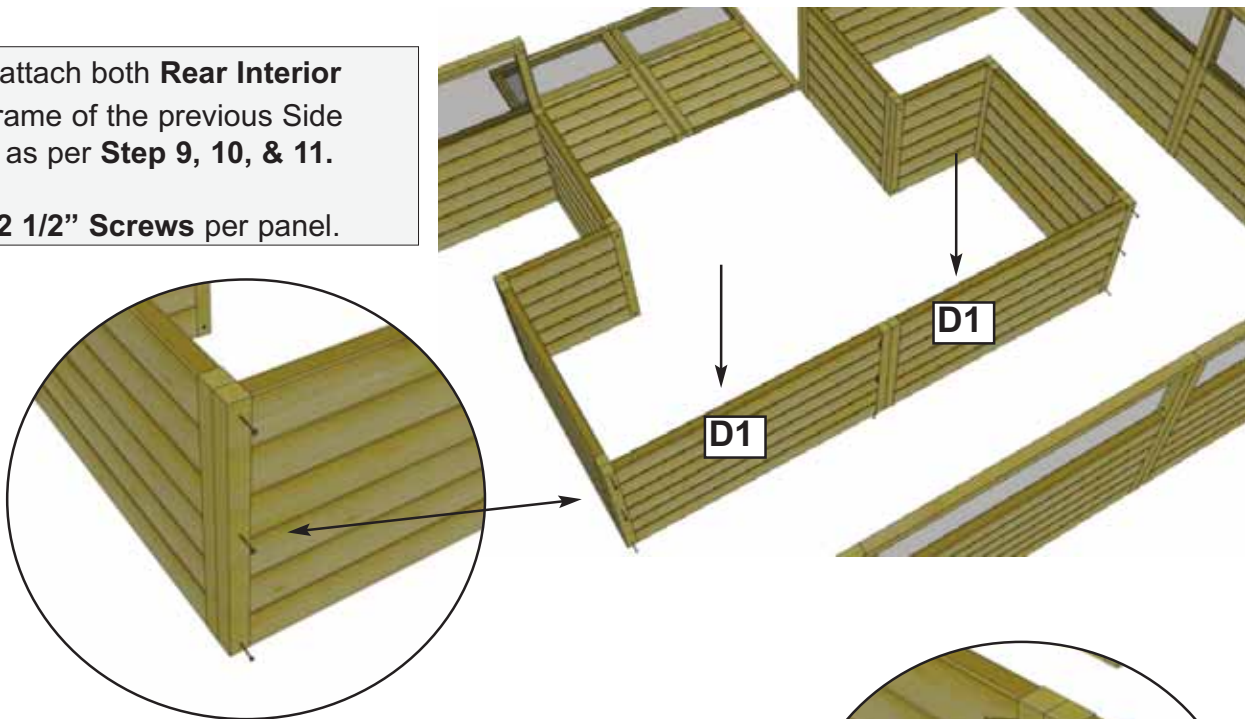

**13.** Align and attach both **Rear Interior Panels** to the frame of the previous Side Interior Panels, as per **Steps 4 & 5**. Angle screw **3 - 2 1/2" Screws** into panel framing to secure completely.

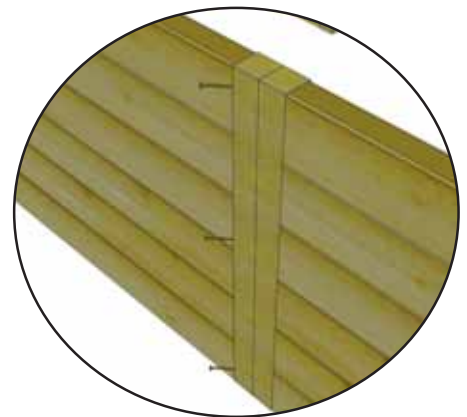

**Important:** Wall construction is now complete. Do not add soil until structural ribs are installed in **Steps 13 - 17**.

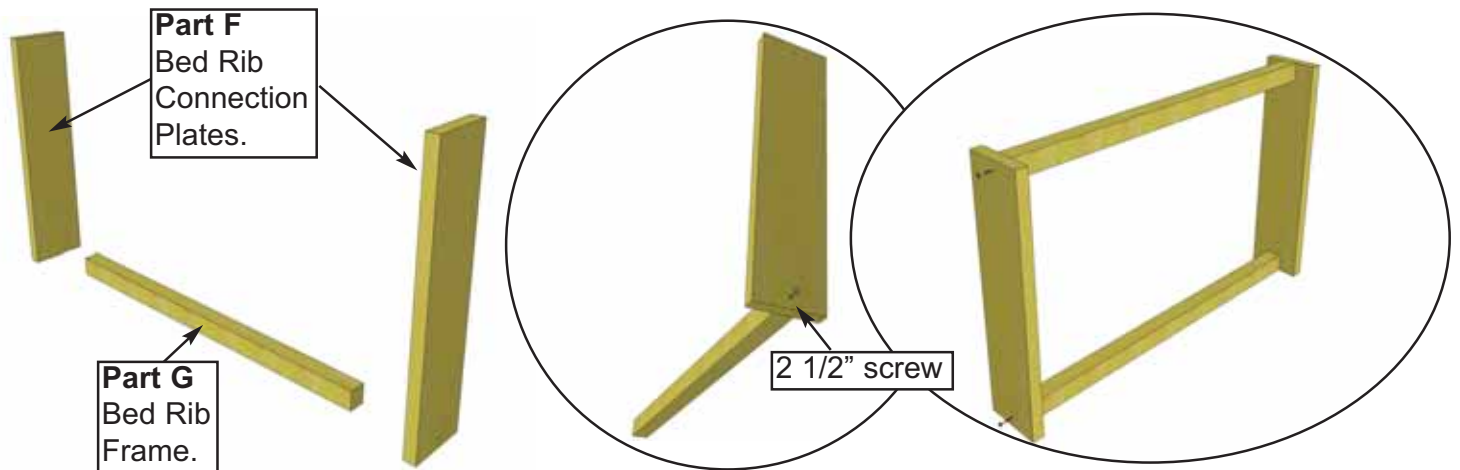

**14.** To complete rib assembly, locate all **10 Bed Rib Connecting Plates** and **10 Bed Rib Frames**

On a level flat surface, screw connection plate and frame together with **1 - 2 1/2" Screw** per end. Align so plate and frame are flush at bottom. Complete both sides.

Parts (Steps 14 - 16)  
**F - Bed Rib Connecting Plates**  
 x 10

**G - Bed Rib Frames (Sides)**  
 (1 1/2" x 1 1/2" x 25 3/8") x 10

Hardware (Steps 14 - 16)

**S1 - 2 1/2" Screws** x 20 total

**SS1 - 1" Screws** x 40 total

**Y2 - 1" Brackets** x 20 total

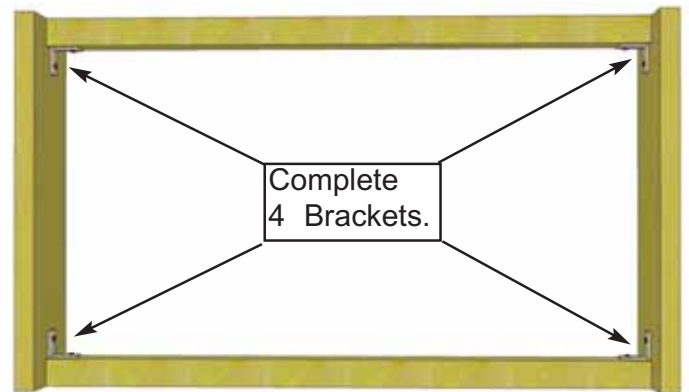
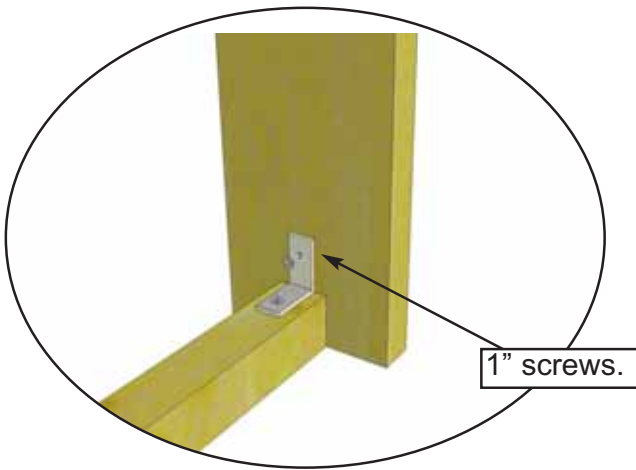

**15.** Locate "**L**" **Brackets** in hardware kit. Four brackets are required for completion of each rib section with 5 rib sections in total need assembly. Position brackets in each corner and secure with **2 - 1" Screws** per Bracket.

Pre-drill first with 1/8" bit to prevent wood from splitting.

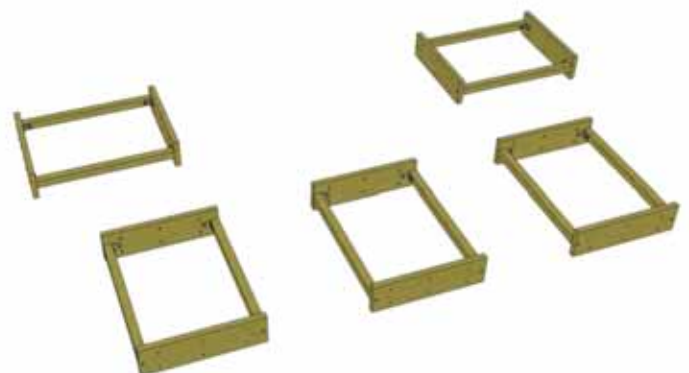

**16.** Complete **5** Bed Rib sections.

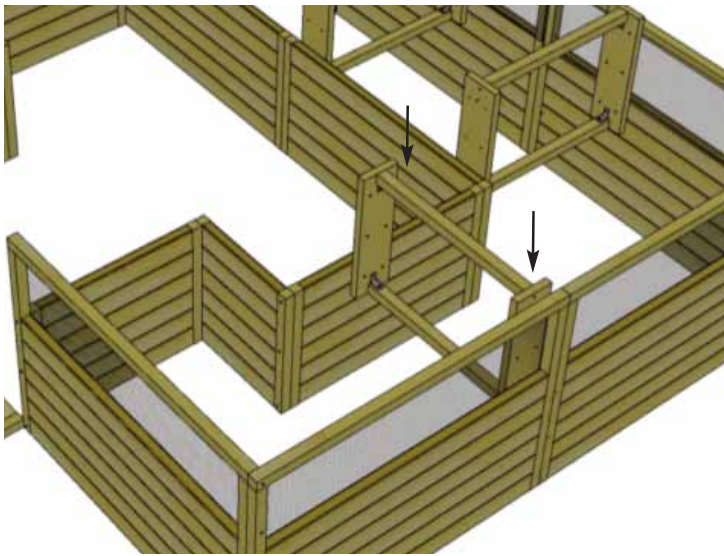

**Important:** Do not align connection plate on vertical wall framing. Offset as shown.

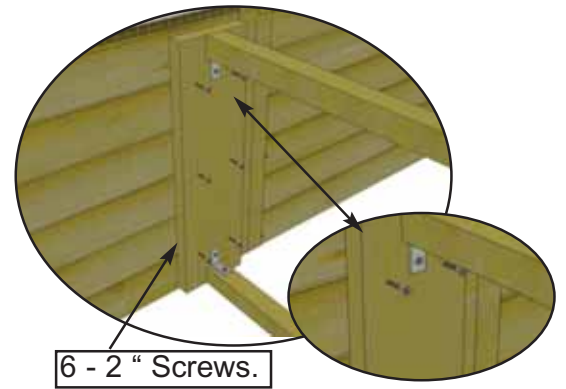

6 - 2" Screws.

**Important:** Do not over screw!  
Complete both sides.

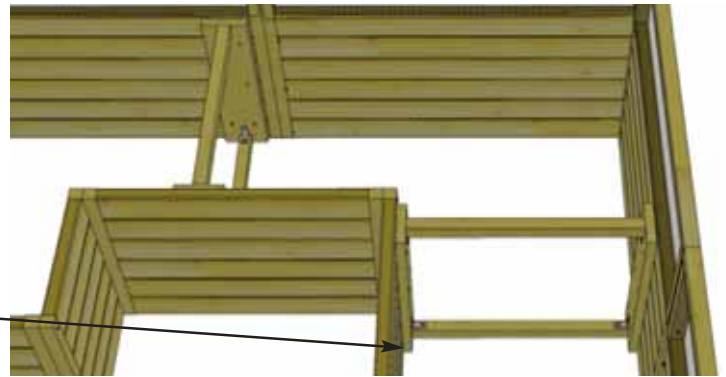

Flush with bottom.

**17.** Lift and position completed short **Bed Rib Frame** and place between side and interior panel siding. Do not center on panel framing and align with bottom of panels.

Secure with **6 - 2" Screws** per plate (both sides of Bed Rib Frame). Pre-drill to prevent splitting, and do not over screw.

Hardware (Steps 17 - 18)  
**S3 - 2" Screws**  
x 60 total

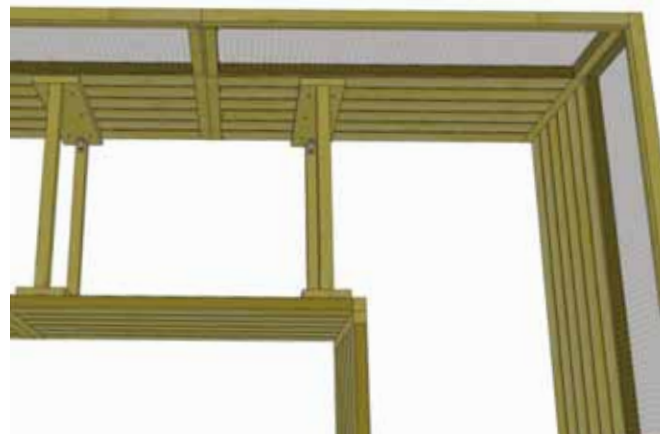
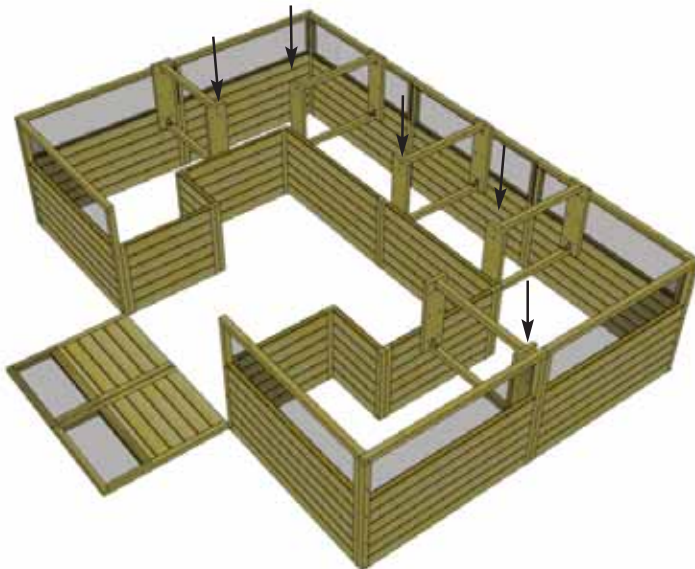

**18.** Complete remaining **4 Bed Rib Frames**, as per **Step 17**.



**19.** Locate the **Door Panels** from **Step 1** and position on flat surface screen down. Attach both hinges to door panel with **3 - 3/4" Black Headed Screws** per hinge.

Space hinges evenly on door frame. Pre-drill shallow hole first to prevent wood from splitting.

Hardware (Step 19)  
**SB1 - 3/4" Black Headed Screws** x 12 Pcs.  
**Y7 - Plastic Hinge** x 4 Pcs.

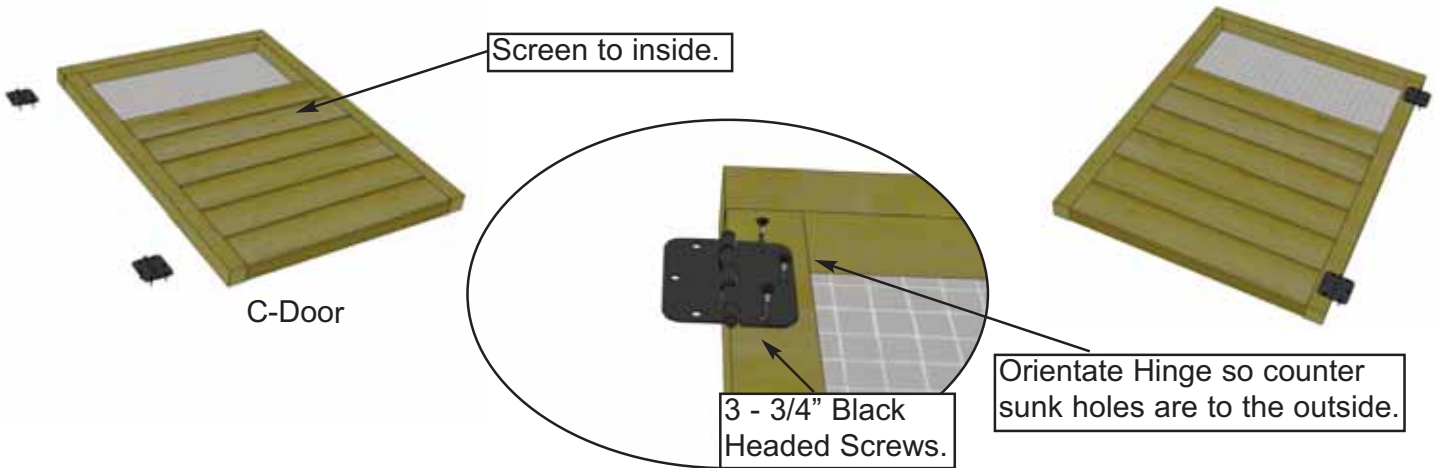

**20.** Attach **Cane Bolt** to rear of left side Door, such that its bottom is flush with the bottom of the door when the bolt is in its upright position. Attach with **2 - 3/4" Black Headed Screws** into each section of cane bolt.

Hardware (Step 20)  
**SB1 - 3/4" Black Headed Screws** x 6 Pcs.  
**Y6 - Cane Bolt** x 1 Pc.

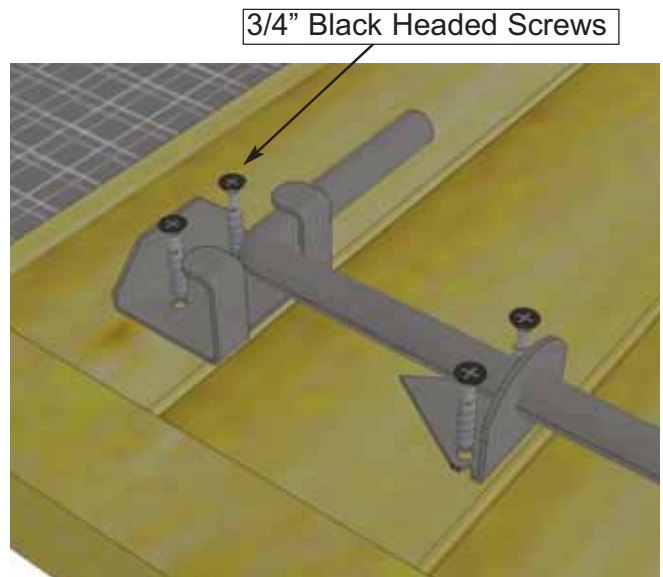
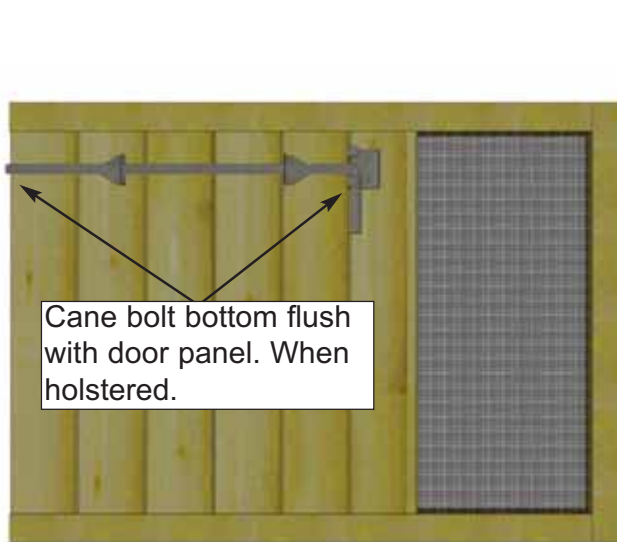

**21.** Attach **Door Threshold** directly below front doors, flush with front wall framing. Use **4 - 1" Screws** and **1 - Brackets** per end of the door threshold.

Parts (Step 21)  
**I - Door Threshold (3/4" x 3 1/2" x 46") x 1**  
Hardware (Step 21)  
**SS1 - 1" Screws x 8 Pcs.**  
**Y2 - Bracket x 2 Pcs.**

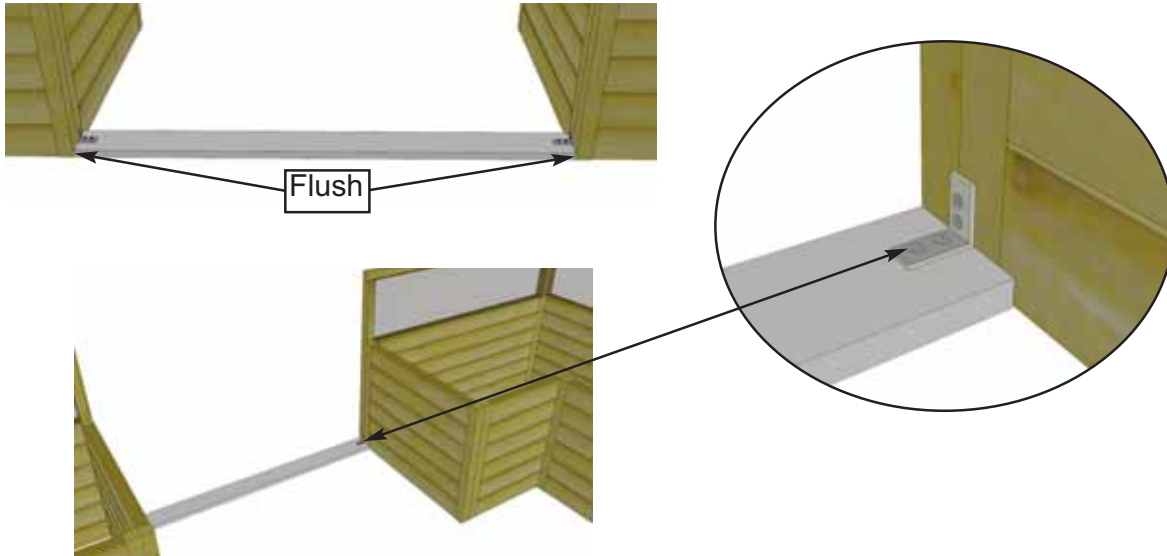

**22.** Attach Door to front wall framing with **3 - 3/4" Black Headed Screws** per hinge. Pre-drill shallow hole first to prevent wood from splitting.

Hardware (Steps 22-23)  
**SB1 - 3/4" Black Headed Screws x 18 Pcs.**  
**Y4 - Black Drop Latch x 1 Pc.**

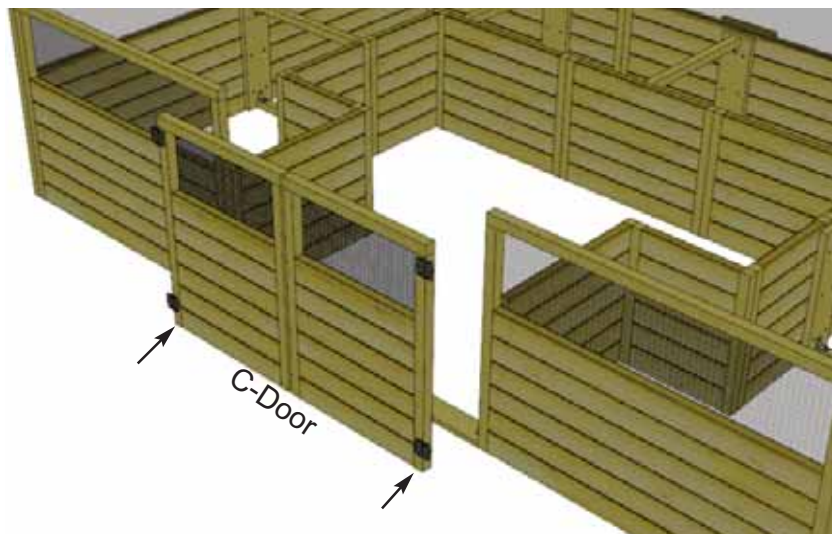

**23.** Attach **Black Drop Latch** (male and female pieces) to door and front wall panel frame with **6 - 3/4" Black Headed Screws**. Pre-drill first to prevent wood from splitting. Do a dry run first to confirm fit before attaching.

**Important:** If installing a deer fence option after assembling the raised bed, do not install the black drop latch until Step 10 in the deer fence assembly.

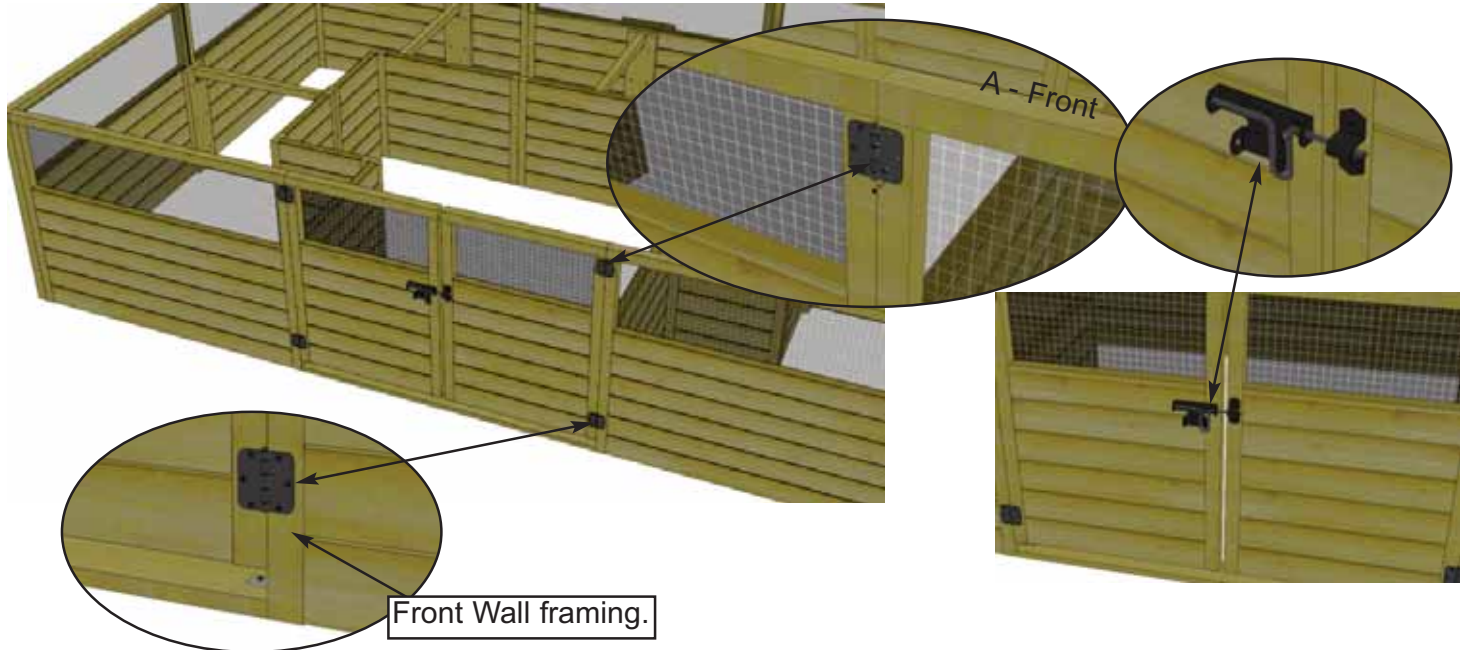

**24.** Mark the point directly below the center of the **Cane Bolt** on the **Door Threshold** when the doors are closed. Reopen the doors and drill through the Door Threshold at this point using a 7/8" drill bit. Check to ensure the cane bolt fits in this hole when dropped into its downward position.

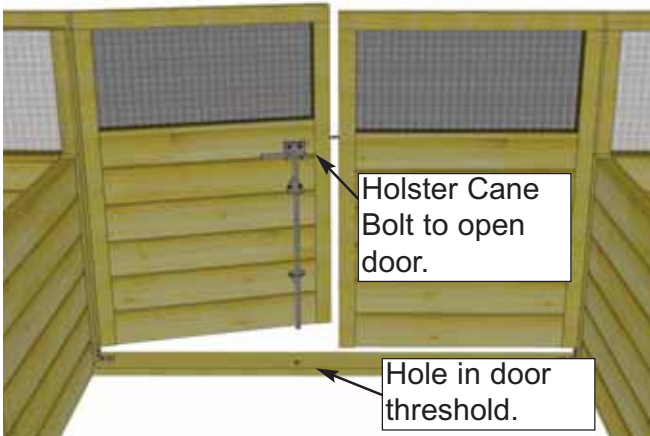
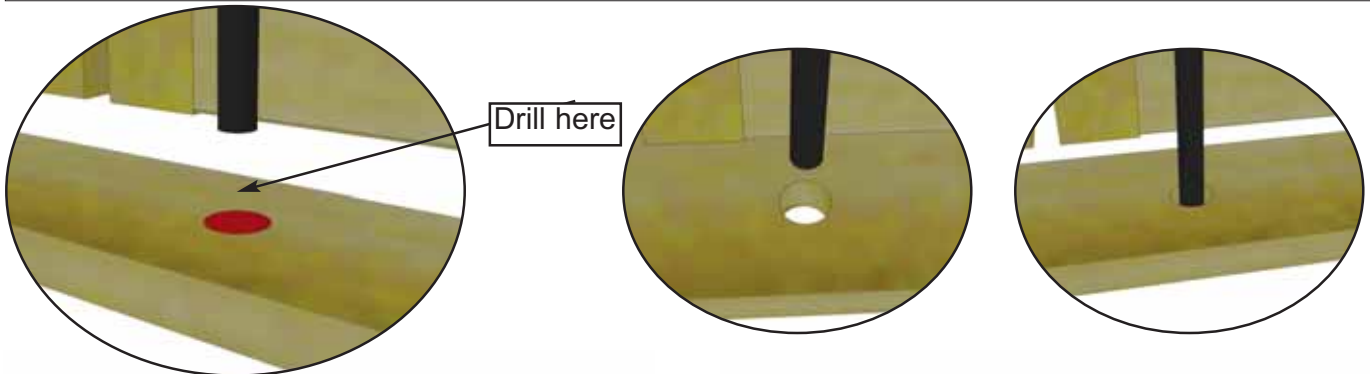



**Congratulations on Assembling your 12'x8' Garden In A Box!**

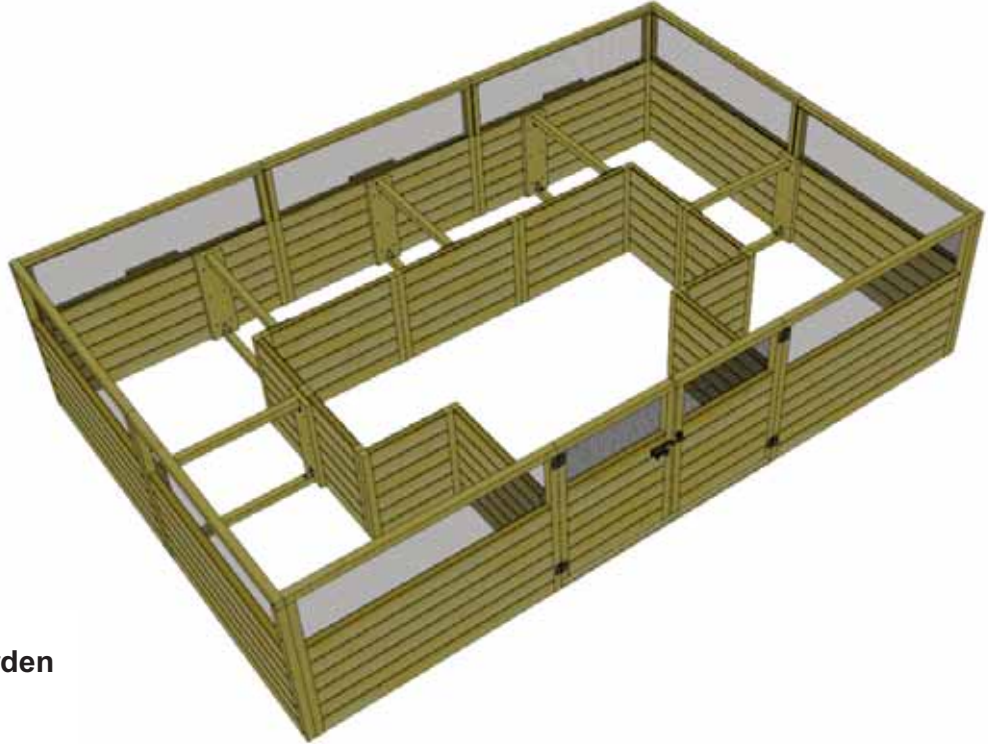

We hope your experience constructing our **12'x8' Garden In A Box** has been both positive and rewarding.

We value your feedback and would like to hear back from you on how well we are doing in the following areas:

1. **Customer Service**
2. **On Time Shipping**
3. **Motor Freight Delivery**
4. **Quality of Materials**
5. **Assembly Manual**
6. **Overall Satisfaction.**

Please call, write or email us at:

**Outdoor Living Today**

Canadian Address  
9393 287th Street  
Maple Ridge, British Columbia  
Canada V2W 1L1

United States Address  
P.O. Box 96  
Sumas, Washington  
USA 98295

**We now recommend you to line the inner walls of your Garden in a Box with landscape fabric or plastic sheeting (not provided) before filling with soil. Note: Raised Garden Beds qualify for our Limited 3-Year Warranty only if the interior of the beds is fully lined with a waterproof barrier before filling the Garden with soil.**



The materials contained in this Assembly Manual may be downloaded or copied provided that ALL copies retain the copyright and any other proprietary notices contained on the materials. No material may be modified, edited or taken out of context such that its use creates a false or misleading statement or impression as to the positions, statements or actions.