

OPERATION WHEN DIRECTLY CONNECTED TO CHIMNEY	
Tested according to	EN 13229
Nominal heat power	9 kW
Efficiency	> 80 %
Consumption of wood	2,8 kg/h
Mass flow of flue gas	8,3 g/s
Average flue gas temperature on the output	297 °C
Heat distribution	
fireplace insert	52 %
door glass (single / double)	48 / - %
Required chimney pressure	12 Pa
Required amount of combustion air	25 m ³ /h
Minimum supply air grating cross-section	700 cm ²
Minimum outgoing air grating cross-section	850 cm ²

OPERATION WITH CONNECTED ACCUMULATION MASS	
Load of wood	4 kg
Total heat output of the burning chamber	16 kW
Mass flow of flue gas	12 g/s
Average flue gas temperature on the output ¹⁾ past 2,4 m of ceramic accumulation system KMS 300 ²⁾	333 °C 202 °C
Heat distribution	
fireplace insert	35 %
door glass (single / double)	48 / - %
adjoining accumulation mass	17 %
Required chimney pressure	12 Pa
Minimum radiant area ³⁾	ca. 4 m ²
Required amount of combustion air	40 m ³ /h

GENERAL TECHNICAL INFORMATION	
Combustion air connection	Ø 150 mm
Total weight / lining weight	ca. 221 / 49 kg
Use in non-ventilated accumulation builds according to craft rules	suitable
Meets values	BlmSchV (Stufe2), 15a BVG

- 1) The Hoxter products are available in the Austrian stove-calculation program for evaluation of firebrick accumulation systems.
- 2) Only a sample calculation! For accurate results is evaluation of each system in the KMS-calculation program from the Ortner company necessary.
- 3) Depends on accumulation period and material characteristics and its thickness. Calculated with heat emission of the radiant area ca. 500 W/m².hr

UKA 37/55/37/57h

Technical data
Version 04/2017

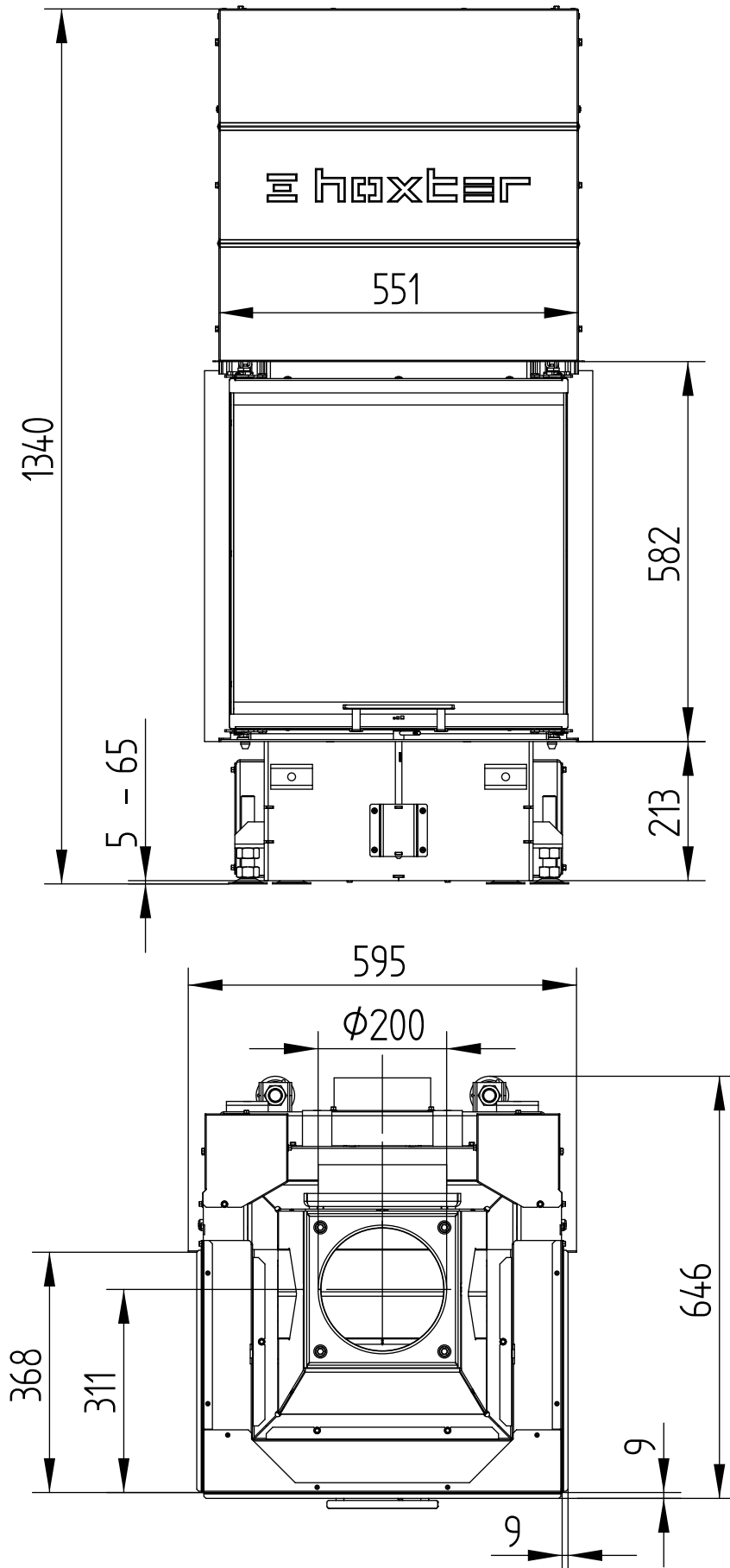

UKA 37/55/37/57h

Technical data
Version 04/2017

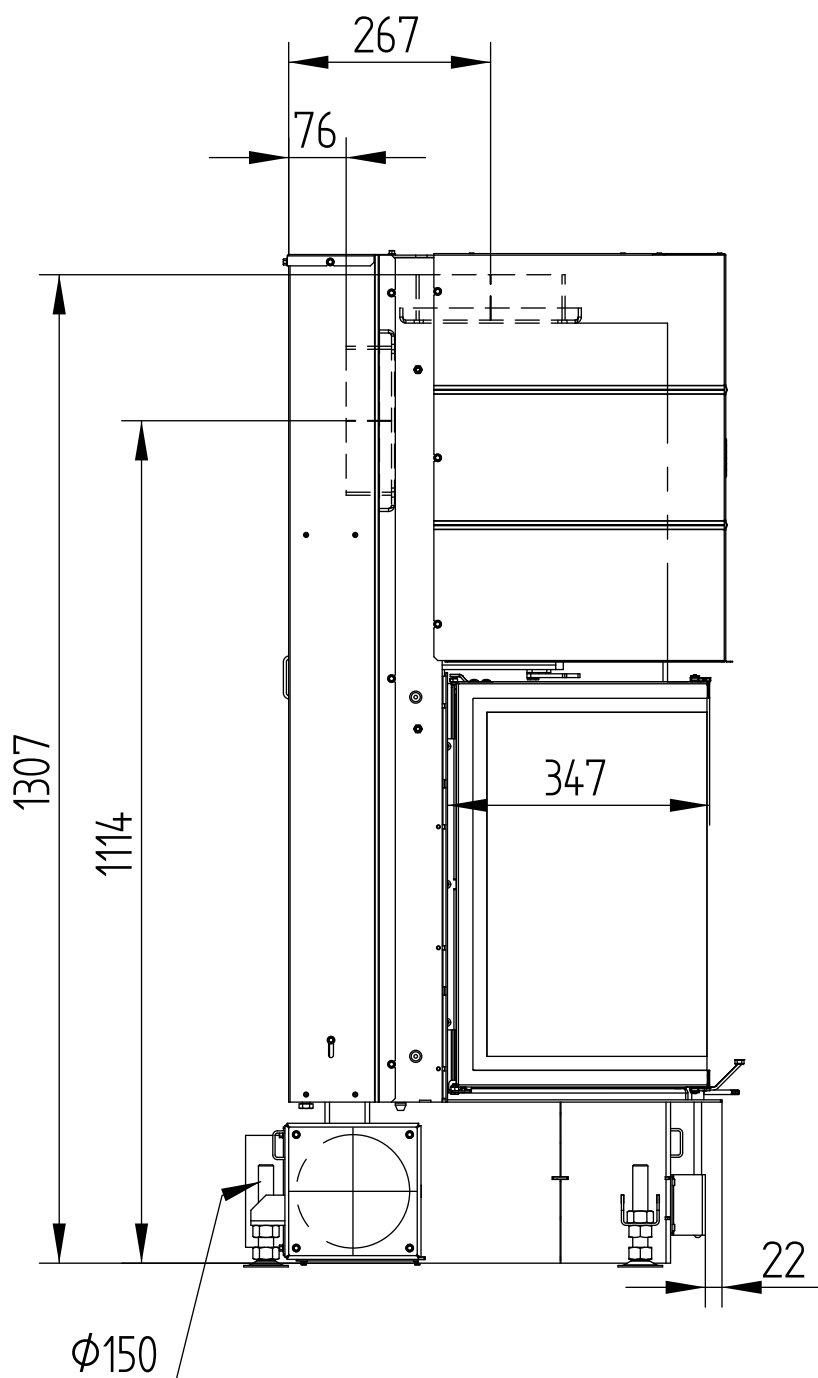

UKA 37/55/37/57h

Technical data
Version 04/2017

BUILD-ON FRAME 8-SIDED

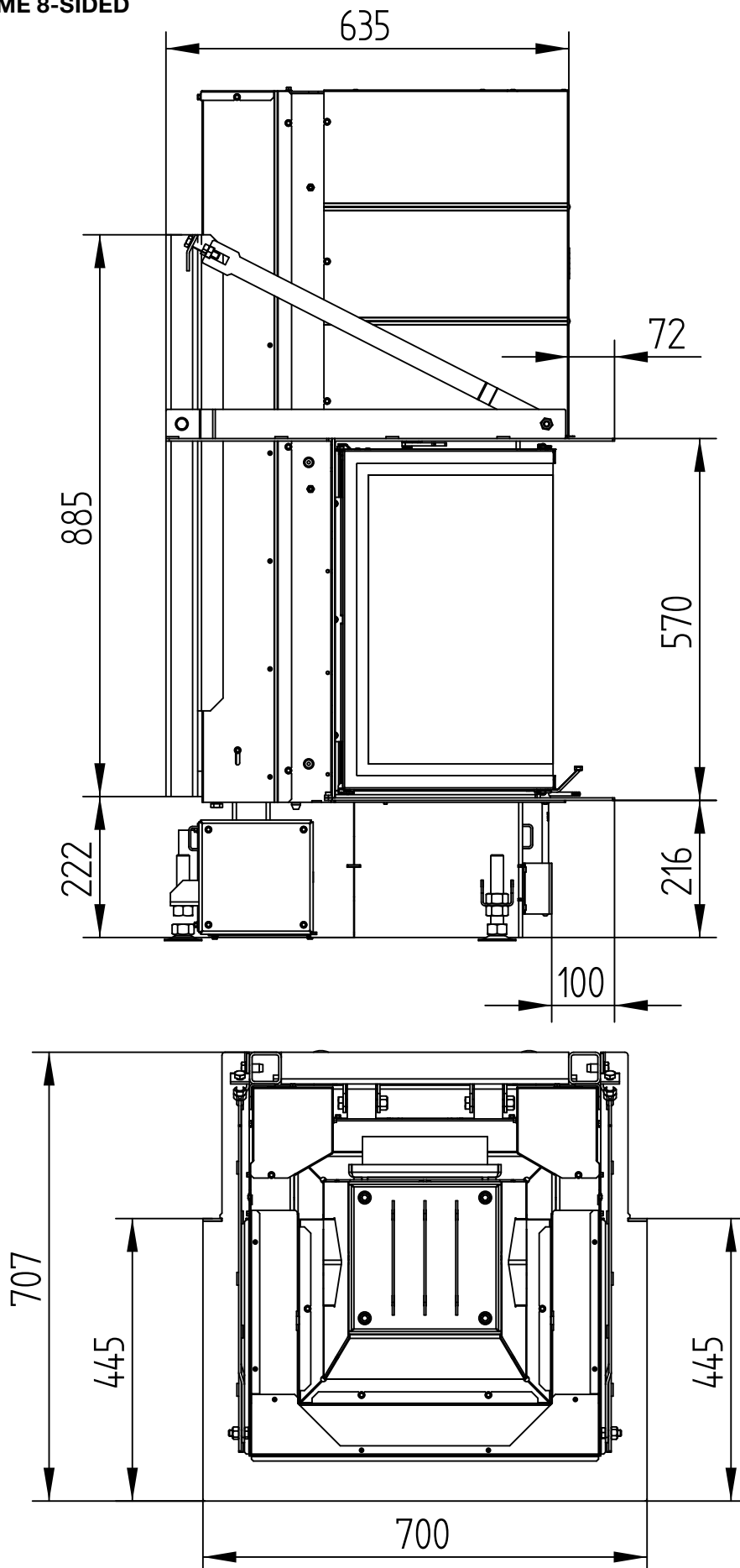

UKA 37/55/37/57h

Technical data
Version 04/2017

BUILD-ON FRAME 3-SIDED

