



# IMPORTANT WARRANTY & INSTALLATION INSTRUCTIONS ATTACHED

*Please Forward All Attached Information to Consumer  
Warranty Not Valid Unless Returned to CORSA Exhaust*

We ask that you take a few moments to complete our warranty registration form:

TO ACTIVATE YOUR LIMITED LIFETIME WARRANTY GO TO:

**[CORSAPERFORMANCE.COM/WARRANTY](https://corsaperformance.com/warranty)**



For Full-Color Installation Instructions, Please Visit:

**[CORSAPERFORMANCE.COM](https://corsaperformance.com) and Search by Part Number**

Please be sure to review the enclosed instructions prior to beginning the installation process.  
If you have any questions about the enclosed parts, instructions or encounter a problem during  
Installation: **CALL CORSA PERFORMANCE TECHNICAL ASSISTANCE AT  
800.486.0999**

**Please take time to read and understand these installation instructions.**

CORSA recommends that installation of this system be performed by a qualified service center or professional muffler installer who has the necessary equipment, tools and experienced personnel. However, if you decide to perform this install, the use of a hoist and an additional person will be required.

**CAUTION:** Never work on a hot exhaust system. Allow time for the vehicle to cool. Always wear eye protection when working under a vehicle.

Please confirm that all parts are present before beginning the factory exhaust system removal and CORSA exhaust system installation.

## Bill of Materials:

- 1 – Rear Muffler Assembly – Passenger - 16CF2095
- 2 – Rear Muffler Assembly – Driver - 16CF2096
- 3 – Axle Pipe Assembly – Passenger - 16CF4107
- 4 – Axle Pipe Assembly – Driver – 16CF4108
- 5 – X-Pipe Assembly – 16CF4121
- 6 – Inlet Elbow Assembly (2) – 16CF4124
- 7 – Tunnel Intermediate Pipe (2) – 16CF4129
- 8 – Hardware Kit – 16CF7052
- 9 – Anti Seize Lubricant

## Recommended Tools:

- Safety Glasses
- 15mm Socket
- Ratchet
- Long Extension
- Grommet Pullers
- Torque Wrench
- Small Flathead Screwdriver

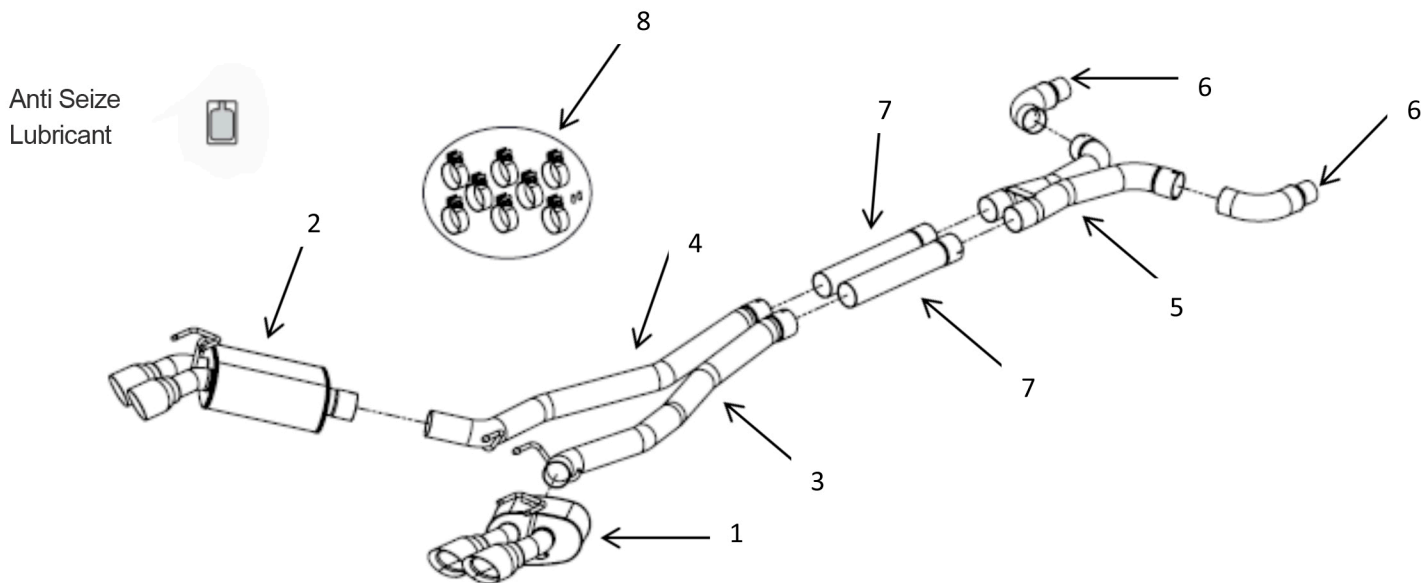

## Removal Of Stock Exhaust:

1. Remove the cross brace from the vehicle using a 15mm socket and ratchet. **(See Fig. A)** Set aside the 4 bolts and the cross brace to be reinstalled during the installation process.
2. Loosen the sleeve clamp on each of the factory catalytic converter pipes using a 15mm socket and ratchet. Pry away the retaining clip on the driver side pipe using a small flathead screwdriver. **(See Fig. B & C)**
3. Locate the vacuum line attached to the outer tip pipe on each of the factory rear mufflers. Detach the vacuum line from each muffler. No tools are required. **(See Fig. D)**
4. Remove the rear hanger mount above each of the rear mufflers using grommet pullers or a similar device. **(See Fig. E)** It may be easiest to remove the double grommet from both the muffler and chassis hangers simultaneously. Set aside both of the double hanger grommets to be reused during the installation process.

**NOTE:** The use of a soapy water solution may aid in the removal and later installation of the hangers in the rubber isolators.

5. Remove both of the axle pipe hangers from the rubber isolators on the hanger mounts using a grommet puller or a similar device. **(See Fig. F)** Carefully move the stock exhaust system down and rearward to free it from the vehicle. **(See Fig. G & H)** The removal of the factory system is now complete.



FIG. A



FIG. B

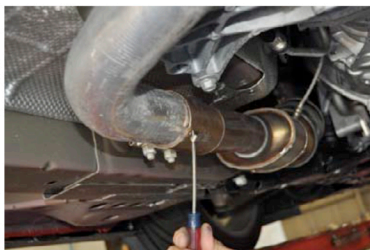

FIG. C



FIG. D



FIG. E



FIG. F



FIG. G



FIG. H

## Installation of CORSA Exhaust System:

**NOTE:** Apply the anti-seize lubricant (supplied) to the threads **ONLY** of all the clamps and flange bolts. Failure to follow this procedure can cause nuts to seize on clamps and potentially destroy threads. After applying anti-seize lubricant, be sure to thoroughly clean hands as lubricant will tarnish stainless steel. All clamps should be tightened using a properly calibrated Torque Wrench. Using an air impact gun will damage the clamp and reduce its ability to effectively seal the joint. It may also cause the joint to separate thereby causing damage to your exhaust system and your vehicle.

**NOTE:** Align all clamps so that the bolt is 90 degrees from the notch in the pipe. (See Fig. A)

1. Remove all exhaust system components from the shipping carton, including the eight 3" clamps, and the two vacuum caps.

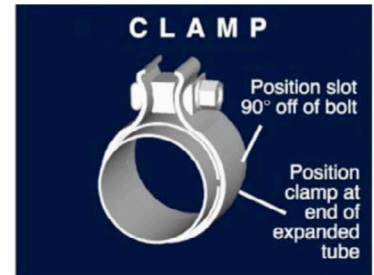

2. Locate the two inlet elbow assemblies. Insert each of the elbow assemblies into the sleeve clamps on the factory catalytic converter pipes. Loosely snug the sleeve clamp bolts using a 15mm socket and ratchet, leaving them loose enough that the pipes can still rotate in the clamps. (See Fig. B & C) Inspect the amount of gap between the transmission cradle and the inside of each elbow assembly. (See Fig. D) There should be around a 1/2" to 3/4" gap at the closest clearance point on each side.

FIG. A

**NOTE:** If the amount of clearance between the elbow pipe and the transmission cradle is either too small or too large, follow step 3. If the clearance amount is within spec on both sides, then skip to step 4.

3. Each factory catalytic converter pipe can be rotated at the two-bolt flange connection with the stock exhaust manifold by around 3 to 4 degrees. This results in around an inch or so of allowable side to side adjustment at the outlet location. (See Fig. E & F) To adjust, loosen the two nuts at the flange connection (from the top) using a 15mm socket and ratchet, and a long extension. (See Fig. G) Rotate the catalytic converter pipe outlet as needed until it is in the right position to achieve the clearance specified in step 2. While holding or bracing the catalytic converter pipe in place, retighten the two nuts, and torque to factory specifications. Repeat for the other side pipe if necessary.
4. Locate the X-pipe assembly, and two of the 3" clamps. Place the two clamps over the inlet side of the X-pipe assembly as shown. (See Fig. H) Slide each of the elbow assemblies into the expansions on the X-pipe inlet, and then snug both clamps using a 15mm socket and ratchet, leaving them loose enough for later adjustment. (See Fig. I & J)
5. Locate the two intermediate pipes, and two more 3" clamps. Properly align the clamp on the intermediate pipe inlet, and slide it onto the X-pipe outlet as shown. (See Fig. K) Repeat for the opposite side pipe. Rotate each pipe until the clamp bolt on each side has at least a 1/2" width of clearance to the differential cooler lines, and then snug both clamps using a 15mm socket and ratchet. (See Fig. L)

6. Replace the factory tunnel brace in its original location. Using a torque wrench, torque the 15mm bolts to 18 ft-lbs. **(See Fig. M)** Using a spacer block, create a ½" inch clearance between the intermediate pipes and the factory tunnel brace. This gap will be maintained when all clamps are tightened in step 14.
7. Locate both axle pipe assemblies and two more 3" clamps. Place a clamp over the inlet of the passenger side axle pipe assembly as shown, and then slide it onto the outlet of the passenger side intermediate pipe. **(See Fig. N)** Insert the axle pipe hanger into the grommet near the differential. **(See Fig. O)**
8. Repeat step 7 for the driver side axle pipe. Snug both axle pipe clamps using a 15mm socket and ratchet, leaving them loose enough for later adjustment. **(See Fig. P)**
9. Install each supplied vacuum cap onto the end of the two vacuum lines that were disconnected in step 3 of the removal process. **(See Fig. Q)** Position the vacuum lines out of the way in the chassis, to where they will not be in contact with the CORSA exhaust system.
10. Locate the passenger side rear muffler assembly and a 3" clamp, as well as one of the double hanger grommets set aside in step 4 of the removal process. Slide the double hanger grommet onto the rear muffler hangers as shown. **(See Fig. R)** Place the clamp over the inlet side of the muffler, then slide the pipe onto the end of the axle pipe assembly. **(See Fig. S)** Slide the double hanger grommet onto the hangers on the vehicle. **(See Fig. T)**
11. Adjust the position and rotation of the driver side muffler onto the axle pipe, until the exhaust tips look properly positioned in the bumper opening, and then snug the clamp using a 15mm socket and ratchet, leaving it loose enough for later adjustment. **(See Fig. U & V)** The minimum amount of pipe overlap should be just enough to prevent any gap from showing through at the base of the notch in the inlet pipe.
12. Repeat steps 10 and 11 for the passenger side rear muffler assembly.
13. Visually inspect the exhaust system position, tip alignment, clamp orientation, and exhaust pipe clearance. Check that the clamps at the X-pipe inlet location have at least a ½" gap to the chassis. **(See Fig. W)** Also check that the clamps at axle pipe inlet location have at least a ½" gap to the differential cooler line mounts on the chassis. **(See Fig. X)** The passenger side axle pipe should have around a ½" gap or more on each side in the tight area between the rear differential and the chassis. The rear muffler cases should have at least a ½" gap or larger to both the spare tire well and the rear sway bar chassis mounts. Make any necessary adjustments at the slip joints.
14. With the tips held in the desired location, start at the front of the vehicle and tighten the nuts on the clamps. Torque nuts to 45 ft-lbs. Remove the spacer block from step 6.
15. It is **STRONGLY SUGGESTED** that all clamps be checked and re-tightened (if necessary) to the recommended torque after initial road testing of the vehicle, as thermal cycling has occurred on the system. Please wait until system has fully cooled to perform this step.



FIG. B



FIG. C



FIG. D



FIG. E

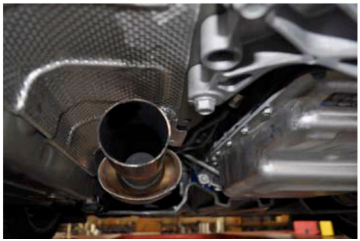

FIG. F

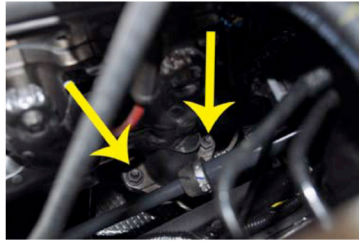

FIG. G



FIG. H



FIG. I



FIG. J



FIG. K



FIG. L



FIG. M



FIG. N

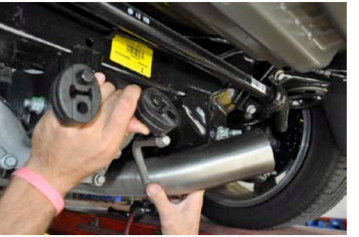

FIG. O



FIG. P

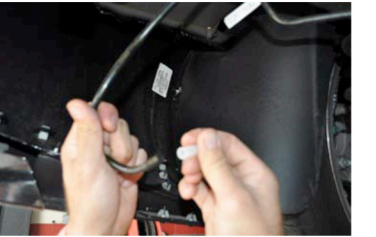

FIG. Q



FIG. R



FIG. S



FIG. T

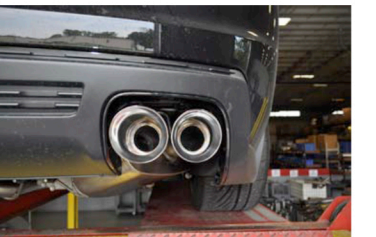

FIG. U

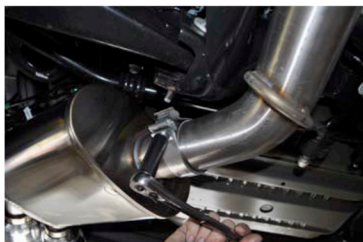

FIG. V



FIG. W



FIG. X

**NOTE:** During cold weather start-ups, you may experience an exhaust sound that is deeper and louder in tone than usual. This is temporary and will diminish to normal levels once your engine has reached its normal operating temperature.

**NOTE:** Immediately following the installation of your CORSA exhaust system, you may experience a trace of smoke after initial start-up. DO NOT be alarmed. The smoke is caused by the burning of a small amount of forming oil residue used in the manufacturing process.

If you have any questions about the installation process, call CORSA Performance and ask one of our Sales & Technical Service Representatives. Do not attempt to make any modifications to parts as this will void your warranty.