



IMPORTANT WARRANTY & INSTALLATION INSTRUCTIONS ATTACHED

*Please Forward All Attached Information to Consumer
Warranty Not Valid Unless Returned to CORSA Exhaust*

We ask that you take a few moments to complete our warranty registration form:

TO ACTIVATE YOUR LIMITED LIFETIME WARRANTY GO TO:
CORSAPERFORMANCE.COM/WARRANTY



**For Full-Color Installation Instructions, Please Visit:
CORSAPERFORMANCE.COM and Search by Part Number**

Please be sure to review the enclosed instructions prior to beginning the installation process. If you have any questions about the enclosed parts, instructions or encounter a problem during installation:
CALL CORSA PERFORMANCE TECHNICAL ASSISTANCE AT 800.486.0999

Please take time to read and understand these installation instructions.

CORSA recommends that installation of this system be performed by a qualified service center or professional muffler installer who has the necessary equipment, tools and experienced personnel. However, if you decide to perform this install, the use of a hoist and an additional person will be required.

CAUTION: Never work on a hot exhaust system. Allow time for the vehicle to cool. Always wear eye protection when working under a vehicle.

Please confirm that all parts are present before beginning the factory exhaust system removal and CORSA exhaust system installation.

Bill of Materials:

- Head Pipe Assembly (25SQ4003)
- Muffler Assembly (25SQ2000)
- Front Tailpipe Assembly (25SQ4004)
- Rear Tailpipe Assembly (25SQ4007)
- Hardware Kit (25SQ7000)
- (1) Packet Anti-Seize Lubricant

Recommended Tools:

- 12mm socket and ratchet
- 14mm socket and ratchet
- 15mm socket and ratchet
- Grommet pullers
- Soapy water
- Safety glasses
- Torque wrench

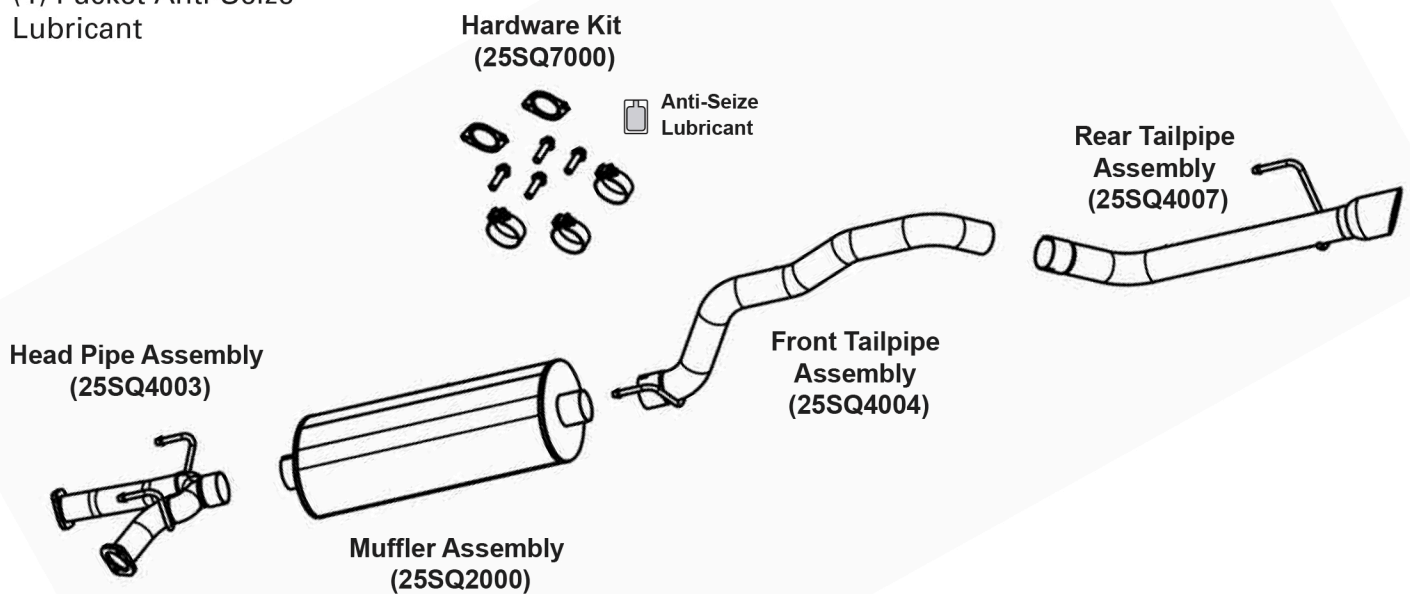

Removal Of Stock Exhaust:

- 1) Use a 12mm socket and loosen the bolt at the clamp connection located at the rear of the muffler. (See Fig. A)
- 2) Remove the grommet from the tailpipe hanger using grommet pullers or similar device. The rear pipe assembly can now be removed from the rear of the vehicle. (See Fig's B & C)
- 3) Use a 14mm socket and loosen the bolts at the flange connections at the front of the factory head pipe assembly. (See Fig's D & E)
- 4) Remove both grommets at the hanger locations of the head pipe assembly using grommet pullers or similar device. (See Fig. F)
- 5) Remove the grommet from the rear of the tunnel muffler hanger using grommet pullers or similar device. The tunnel muffler assembly can be completely removed from the vehicle. This completes the removal of the stock exhaust system. (See Fig's G & H)



FIG. A



FIG. B



FIG. C



FIG. D



FIG. E

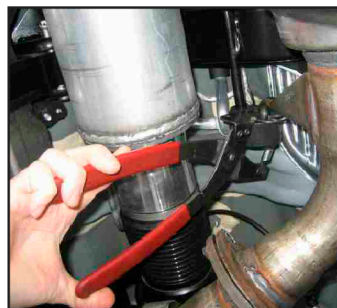

FIG. F



FIG. G



FIG. H

If at any time you need technical assistance, call (800) 486-0999 to speak with a CORSA Representative.

Installation of CORSA Exhaust System:

NOTE: Apply the anti-seize lubricant (supplied) to the threads **ONLY** of all the clamps and flange bolts. Failure to follow this procedure can cause nuts to seize on clamps and potentially destroy threads. After applying anti-seize lubricant, be sure to thoroughly clean hands as lubricant will tarnish stainless steel. All clamps should be tightened using a properly calibrated Torque Wrench. Using an air impact gun will damage the clamp and reduce its ability to effectively seal the joint. It may also cause the joint to separate thereby causing damage to your exhaust system and your vehicle.

NOTE: Align all clamps so that the bolt is 90 degrees from the notch in the pipe. (See Figure 1)

- 1) Locate the CORSA Head Pipe assembly and gaskets supplied in the hardware kit. Mate the flanges up with the factory flange and use the bolts supplied with the CORSA hardware kit and tighten down to 25 Ft-lbs. Insert the hangers into the factory grommets. (See Fig's I & J) **Note: Using a soapy solution on the grommet hole will make the job easier.**
- 2) Slide a supplied 3" TORCA clamp over the inlet of the CORSA front Tailpipe assembly. From the center of the vehicle slide the pipe over the axle and allow the pipe to sit loose at this time. (See Fig's K, L, and M)
- 3) Slide a supplied 3" TORCA clamp over the inlet of the CORSA Muffler. **Make sure the weep hole is facing down** then slide the muffler onto the Head Pipe and pre-tighten the clamp using a 15mm socket. (See Fig's N and O)
- 4) Slide the front tailpipe assembly onto the muffler and insert the hanger into the factory grommet. Pre-tighten the clamp using a 15mm socket. (See Fig. P)

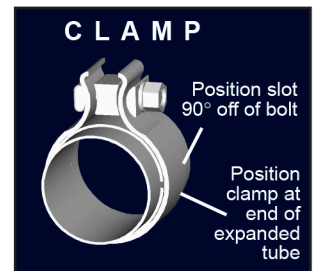

Figure 1

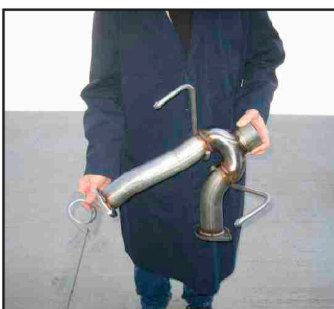

FIG. I

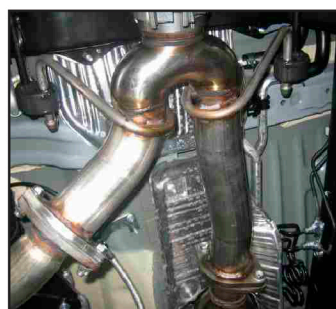

FIG. J



FIG. K



FIG. L

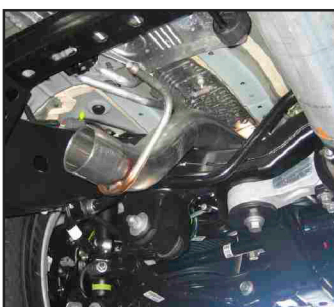

FIG. M



FIG. N



FIG. O



FIG. P

- 5) Locate the CORSA Rear tailpipe assembly and slide a 3" TORCA clamp over inlet end of the pipe. Insert the hanger into the factory grommet first then insert the pipe onto the end of the front tailpipe assembly. Align the tip so that it is centered with the valence opening. Pre-tighten the clamp at this time. **(See Fig's Q, R, S and T)**
- 6) Starting from the front of the CORSA exhaust system tighten all TORCA clamps to **45 ft-lbs** using a torque wrench. This completes the installation of the CORSA system.
- 7) **It is strongly recommended that all clamps be checked and tightened after road testing the vehicle. Allow the exhaust system to cool before working on it.**



FIG. Q

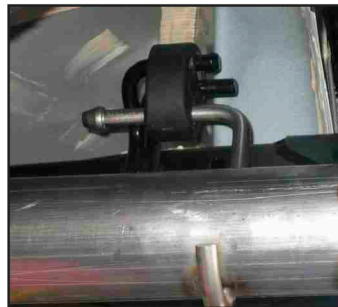

FIG. R



FIG. S



FIG. T

NOTE: During cold weather start-ups, you may experience an exhaust sound that is deeper and louder in tone than usual. This is temporary and will diminish to normal levels once your engine has reached its normal operating temperature.

NOTE: Immediately following the installation of your CORSA exhaust system, you may experience a trace of smoke after initial start-up. DO NOT be alarmed. The smoke is caused by the burning of a small amount of forming oil residue used in the manufacturing process.

If you have any questions about the installation process, call CORSA Performance and ask one of our Sales & Technical Service Representatives. Do not attempt to make any modifications to parts as this will void your warranty. Assistance: (800) 486-0999.

