

iMod Installation

Switch-plate

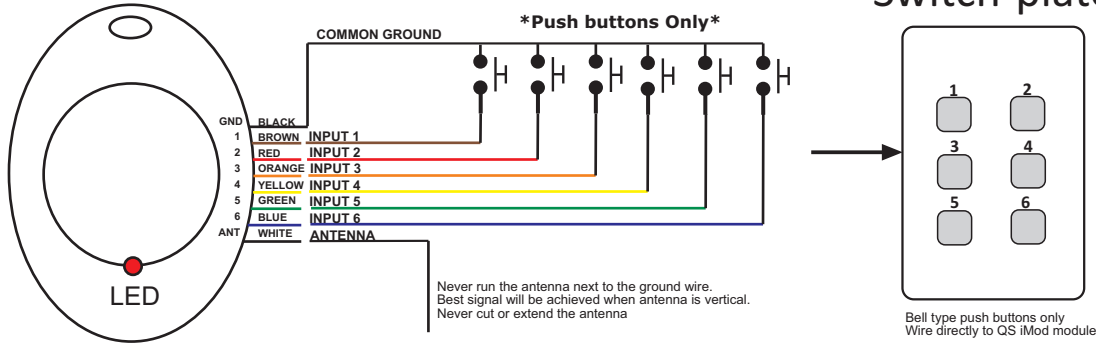

Bell type push buttons only
Wire directly to QS iMod module

LED INDICATOR

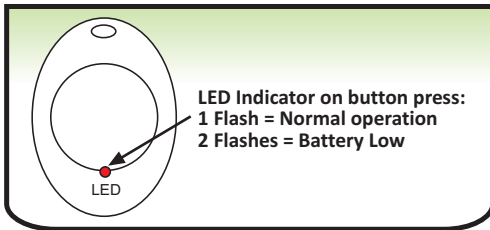

Button Linking:

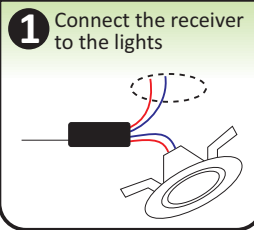

To unlink a button: Repeat steps 2&3.

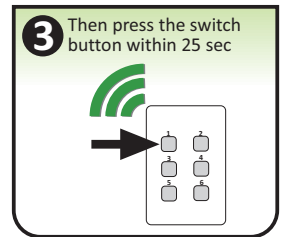
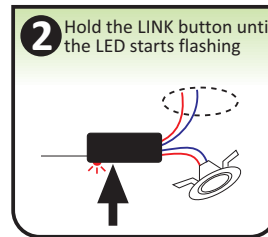

BATTERY REPLACEMENT

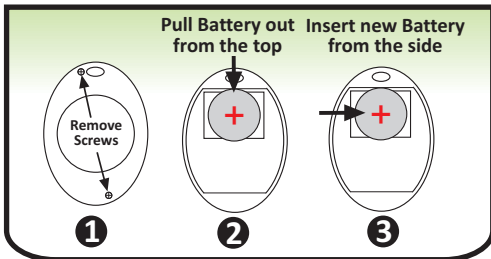

BUTTON OPERATION

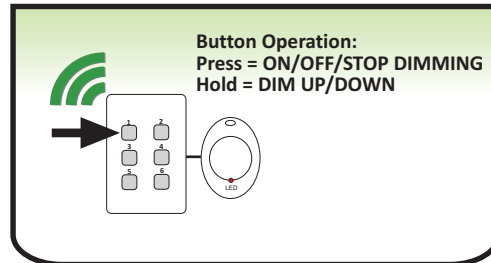

iMod Installation

Switch-plate

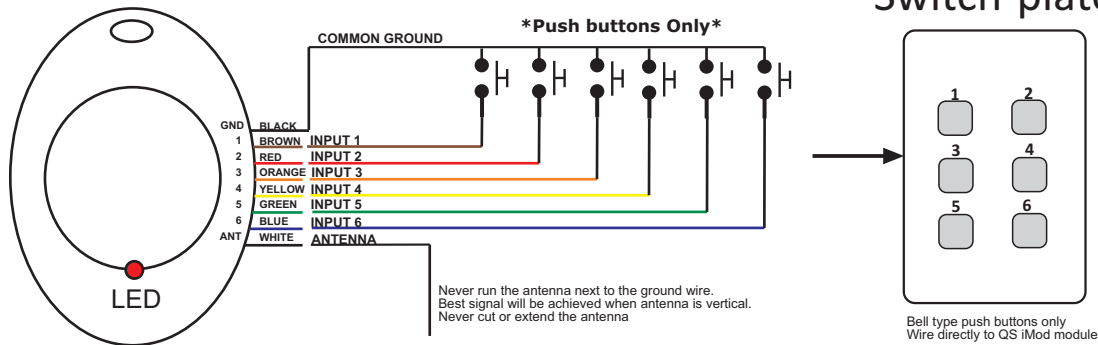

Bell type push buttons only
Wire directly to QS iMod module

LED INDICATOR

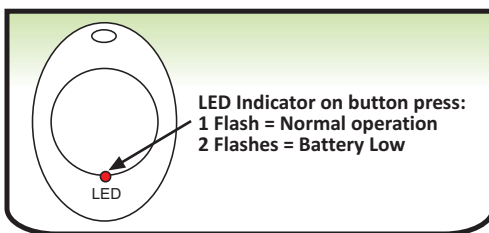

Button Linking:

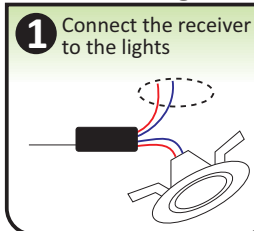

To unlink a button: Repeat steps 2&3.

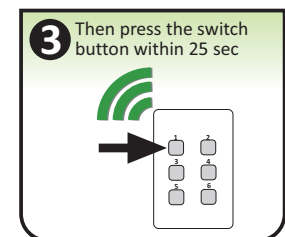
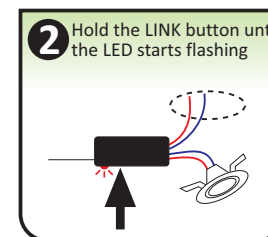

BATTERY REPLACEMENT

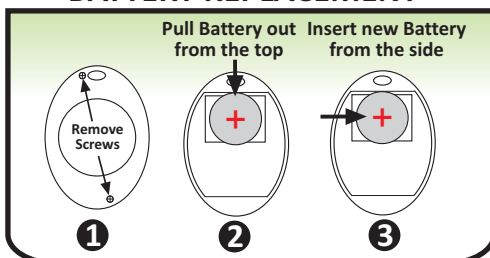

BUTTON OPERATION

